

boehlerit

Fräsen
Milling



Hartmetalle und Werkzeuge von Boehlerit setzen Maßstäbe in der Bearbeitung von Metall, Holz, Kunststoff und Verbundwerkstoffen. Die Schneidstoff- und Werkzeugspezialisten aus der Stahlstadt Kapfenberg in der Steiermark lösen durch ihre 'Nähe zum Stahllabor' anspruchsvollste Bearbeitungsaufgaben in Werkstoffen der Zukunft. Schneidstoffe, Halbzeuge und Präzisionswerkzeuge sowie Werkzeugsysteme zum Fräsen, Drehen, Bohren und Umformen sorgen weltweit für Prozesssicherheit und Effizienz. Zum umfassenden Produktspektrum von Boehlerit gehören auch hoch spezialisierte Werkzeuge für die Kurbelwellenbearbeitung sowie für die Hüttentechnik zum Drehschalen, zur Rohr- und Blechbearbeitung sowie der Schwerzerspannung. Eine weitere Stärke von Boehlerit sind Hartmetalle für Konstruktionsteile und für den Verschleißschutz. Auch im Bereich der Beschichtungstechnologie schafft Boehlerit von der weltweit ersten Nano-CVD Anbindungsschicht bis zur härtesten Diamantschicht globale Alleinstellung. Außerdem ist Boehlerit mit seinem langjährigen Know-How in der Metallurgie, der Beschichtungstechnologie und mit modernster Presstechnik ein kompetenter Entwicklungspartner für Toolmaker.

Die Marke Boehlerit wurde 1932 für die Hartmetallfertigung des Stahlherstellers Böhler in Düsseldorf gegründet. 1950 begann der Aufbau einer zweiten Hartmetallfertigung in Kapfenberg/Österreich, am heutigen Hauptsitz der Boehlerit Gruppe. Zwischenzeitlich hat Boehlerit auch Produktions- und Vertriebsstandorte in Deutschland, Spanien, Türkei, Ungarn, Tschechien, Slowakei, China, USA, Polen, Brasilien und Mexiko. Mit weiteren exklusiven Vertriebspartnern und gemeinsam mit der Bilz-Gruppe ist Boehlerit auf fast allen Kontinenten, in über 40 Industrieländern, heimisch.

Seit dem Jahr 1991 gehört Boehlerit zum Leitz Firmenverband in Oberkochen/Deutschland und somit zur heutigen Unternehmensgruppe der Familie Brucklacher (Bilz, Boehlerit und Leitz) mit weltweit 4000 Mitarbeitern. 800 erfahrene Mitarbeiter (500 am Standort Kapfenberg) erwirtschaften, in der Boehlerit Gruppe, jährlich einen Umsatz von ca. 110 Mio. Euro. Davon investiert Boehlerit 5 % direkt in Forschung und Entwicklung. Mit modernsten Analysemethoden und in enger Zusammenarbeit mit Universitäten und Forschungseinrichtungen werden ständig neue Produkte rund um den Schneid- und Verschleißschutzstoff Hartmetall entwickelt. Das macht die Innovationsfabrik Boehlerit zu einem der international führenden Anbieter kundenspezifischer Lösungen und Dienstleistungen in anspruchsvollen Anwendungsbereichen.

Boehlerit – Pioneers in Carbide Development

Carbides and tools from Boehlerit are the pace-setters for new standards in the machining of metal, wood, synthetic and composite materials. The cutting materials and tools specialist from the steel town Kapfenberg in Styria has the answers for the most challenging machining tasks for materials of the future with its direct line to the 'steel lab'. Reliable and efficient processes are ensured worldwide with cutting materials, semi-finished products, precision tools and tooling systems for milling, turning, drilling and forming. The comprehensive Boehlerit product range includes highly specialised tools for crankshaft machining, tube and pipe machining, bar peeling and heavy-duty machining operations in the steel industry. Further Boehlerit strengths include carbides for structural components and for wear-protection. In coating technology, Boehlerit achieved a world first and unique positioning globally with its Nano CVD bonding layer through to the hardest diamond coatings. Added to this, Boehlerit is the expert development partner for toolmakers with its unrivalled know-how and many years of mastery in metallurgy, coatings systems and the latest pressing technologies.

The Boehlerit brand was established in 1932 for the carbide production of the Böhler Steelworks in Dusseldorf, Germany. A second carbide production centre was established at Kapfenberg/Austria in 1950, at what is now the world headquarters of the Boehlerit Group. Boehlerit today has production and sales locations in Germany, Spain, Turkey, Hungary, the Czech Republic, Slovakia, China, the USA, Poland, Brazil and Mexico. Boehlerit is at home on virtually every continent and in 40 leading industrial nations working hand-in-hand with exclusive sales partners and its partners in the Bilz Group.

Since 1991, Boehlerit has been a part of the Leitz Corporate Group in Oberkochen/Germany and is thus a part of the group of companies owned by the Brucklacher family (Bilz, Boehlerit and Leitz). Boehlerit employs 800 experienced employees (500 in Kapfenberg) 4,000 worldwide in the Leitz Corporate Group. 5 % of its annual turnover of around 110 million euros in the Boehlerit Group is invested directly in research and development every year. Using state-of-the art analytical methods and profiting from its close cooperation with universities and research institutes, Boehlerit generates a constant flow of new products and solutions revolving around carbides and their use for cutting and wear-protection. All of this has made the innovation factory Boehlerit one of the world's leading providers of customised solutions and services for industries with the most demanding applications.



Technologievorteile / Kundennutzen	Technological advantages / customer benefits	4
Sortenübersicht / Sortenbeschreibung zum Fräsen	Grade overview / Grade description milling	6
Programmübersicht Werkzeuge Fräsen und Aufnahmen	Programme overview milling tools and chucks	10
ISO Fräswendeplatten	ISO indexable inserts for milling	
Bezeichnungssysteme	Designation systems	14
Wendeplattenprogramm	Indexable inserts program	21
Fräswerkzeuge	Milling tools	
Fräser 45° für Wendeplatten	Milling cutters 45° for indexable inserts	49
Schnittwertempfehlungen Fräsen 45°	Cutting data recommendations milling 45°	76
Fräser 90° für Wendeplatten	Milling cutters 90° for indexable inserts	79
Schnittwertempfehlungen Fräsen 90°	Cutting data recommendations milling 90°	130
3D Fräsen	3D milling	133
Schnittwertempfehlungen 3D Fräsen	Cutting data recommendations 3D milling	174
Vollhartmetallfräswerkzeug		177
Vollhartmetallverlängerungen	Solid carbide extensions	294
Fräser Aufnahmen Bilz	Chucks for milling cutter Bilz	298
Technische Hinweise	Technical hints	
Ersatzteile - Schrauben	Spare parts - Fixation screw	308
DINA PLUS® Torx-Schraubendreher Kit	DINA PLUS® torque wrench kit	310
Torx-Schraubendreher	Torque wrench	310
Rampe eintauchen	Ramping	312
Formeln	Formulas	312
Berechnung des Eingriffswinkels φ_s	Calculation of approach angle φ_s	313
Maße, Einheiten, Anwendungsformeln	Dimensions, units and application formulas	314
Lösungen von Anwendungsproblemen	Solutions for application problems	315
Anhang	Attachment	
Werkstoff-Vergleichstabelle	Material comparison chart	316
Vertriebspartner	Distributors	335
Vertriebstöchter	Subsidiaries	336



Kapfenberg in der Steiermark / Kapfenberg in Styria / Österreich / AUSTRIA

Technische Änderungen und Druckfehler vorbehalten. Nachdruck, auch auszugsweise, ist nur mit unserer Zustimmung gestattet. Alle Rechte vorbehalten. Irrtümer, Satz- oder Druckfehler berechtigen nicht zu irgendwelchen Ansprüchen. Abbildungen, Ausführungen und Maße entsprechen dem neuesten Stand bei Herausgabe dieses Kataloges. Technische Änderungen müssen vorbehalten sein. Die bildliche Darstellung der Produkte muss nicht in jedem Falle und in allen Einzelheiten dem tatsächlichen Aussehen entsprechen.

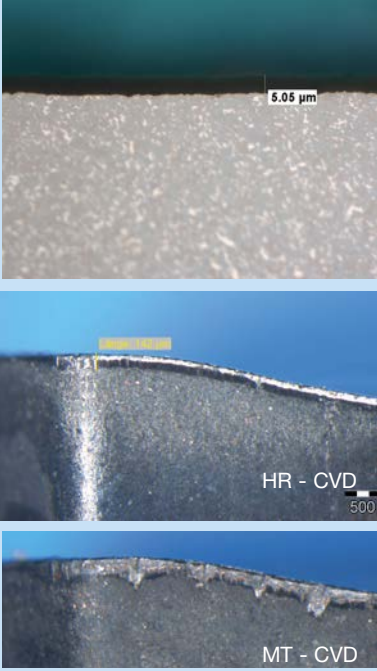
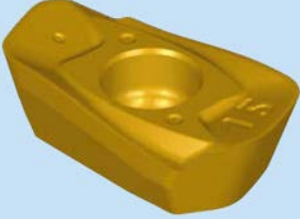
Subject to changes from technical development and printing errors. This publication may not be reprinted in whole or part without our express permission. All right reserved. No rights may be derived from any errors in content or from typographical or typesetting errors. Diagrams, features and dimensions represent the current status on the date of issue of this catalogue. We reserve the right to make technical changes. The visual appearance of the products may not necessarily correspond to the actual appearance in all cases or in every detail.

<p>Große Schneidstoffvielfalt im Portfolio, um dem breiten Materialspektrum gerecht zu werden - daraus resultieren optimale Zerspanungsverhältnisse.</p> <p>The big range of cutting grades for dealing with a very broad spread of materials enables us to ensure optimum cutting conditions.</p>		<p>Hohe Wirtschaftlichkeit und Bearbeitungssicherheit auf einem breiten Werkstoffspektrum.</p> <p>High economic machining and security on a wide range of materials.</p>
<p>Patentiert neuartige TERAspeed 2.0 AlTiN-Schicht, abgeschieden mittels HR-CVD Technologie (HR = High Reactivity).</p> <p>Patented new TERAspeed 2.0 AlTiN layer, deposited by means of HR-CVD technology (HR = High Reactivity).</p> <p>HR - CVD TERAspeed 2.0 HR - CVD TERAspeed 2.0</p> <p>MT - CVD Nano schwarz MT - CVD Nano black</p>		<p>Auf Grund des hohen Aluminiumgehalts dieser AlTiN-Schicht und ihrer neuartigen Nanostruktur konnten erstmals so gegenläufige Eigenschaften, wie eine hohe Zähigkeit mit gleichzeitig extremer Schichthärte und Verschleißbeständigkeit kombiniert werden.</p> <p>The high aluminium content of this AlTiN layer and its innovative nanostructure make it possible, for the first time, to combine properties that are as such opposing – such as toughness, outstanding layer hardness and wear resistance.</p>
<p>Goldlox Dicke PVD-AlTiN-Beschichtung. Hoher Aluminiumgehalt bewirkt hohe Verschleißbeständigkeit bei höheren Temperaturen. Beschichtung mit besonders glatter Oberfläche und TiN-Deckschicht zur Verschleißerkennung.</p> <p>Goldlox Thick PVD AlTiN coating. High aluminium content procures big wear resistance at higher temperatures. Coating with especial smooth surface and TiN top layer for wear recognition.</p>		<p>Erhöhte Standzeit bei unterschiedlichen Stählen, sowie einfache Verschleißerkennung.</p> <p>Increased tool life on different steels as well as simple wear recognition.</p>
<p>HiPIMS liefert im Vergleich zu anderen PVD-Schichten bessere Bruchresistenz bei gleicher Härte, sowie plus, gleichmäßigere Schichtverteilung um die Schneidkante.</p> <p>Compared to other PVD coatings, HiPIMS provides better break resistance at the same hardness. Plus, more even layer distribution around the cutting edge.</p>		<p>Durch extrem dichte, mikrokristalline und verschleißfeste Schichten höchste Performance und Prozesssicherheit.</p> <p>Highest performance and process security due to extrem thick microcrystalline and wear resistant layers.</p>

<p>Substrate Zur Herstellung des Fräsprogramms werden verschiedene Hartmetallsubstrate verwendet, die so aufeinander abgestimmt sind, dass ein breites Anwendungsfeld von Schruppen bis Schlichten von Guss, Stahl Rostfreimaterialien, Superlegierungen und Aluminium mit Plan- und Eckfräsern lückenlos bearbeitet werden kann.</p> <p>Substrates Various carbide substrates are used to produce the range of milling grades fine-tuned to cover an extensive range of applications: from roughing to finishing, from cast to stainless steel materials superalloy and aluminium, from face to step milling.</p>		<p>Damit die Bearbeitungssicherheit sichergestellt ist, dass jeder Kundenanforderung, egal ob weniger Freiflächenverschleiß, Stabilität gegen Schneidkantenausbrüche, Kammiss- oder Kolkbeständigkeit, optimal begegnet werden kann.</p> <p>This is how we ensure that every customer requirement is met: be it minimal flank wear, resistance to chipping of the cutting edge, resistance to thermal cracking or crater wear.</p>
<p>Multifunktionale Werkzeugsysteme Multi functional tool systems</p>		<p>Ein Grundkörper Zwei Bearbeitungen Einsparung von Trägerkörpern und Lagerkosten</p> <p>Cutter body Two machinings Saving of bodies and ware housing costs</p>
<p>High End Werkzeuge High End Tools</p>		<p>Exakte Rundlaufeigenschaften, alle Werkzeuge mit innerer Kühlmittelzuführung. Nickel implantiert, verbesserte Dauerfestigkeit der Fräsergrundkörper durch spezielle Werkstoffe und Wärmebehandlungen</p> <p>Exact true running characteristics, all tools with internal coolant supply. Nickel implantated. Improved endurance strength of the milling body due to special material and through heat treatment</p>
<p>Dynamische FEM Design (Finite Elemente Methode) Technologie</p> <p>Dynamic FEM Design (Finite Elemente Method) technology</p>		<p>Stabile Werkzeuge mit exzellenten Dauerfestigkeitseigenschaften und optimalen Spanablauf</p> <p>Stable tools with excellent endurance strengths characteristics and optimized chip flow</p>
<p>Größe des Eckenradius in der Platte sowie Markierung zur Positionierung bzw. Nummerierung der Schneiden mitgepresst.</p> <p>Size of the corner radius pressed in the insert and marking for positioning and/or numbering of cutting edges</p>		<p>Leichte Orientierung für die Anwender und gute Rundlaufeigenschaften</p> <p>Easy orientation for the operator and good true running characteristics</p>

Sortenübersicht Grade overview

Sorte Grade	ISO	Anwendungsbereich Application range							Werkstoffgruppe Material group						Bearbeitungsverfahren Application				Farbliche Darstellung der WSP je nach Beschichtung Color guide for inserts depending on coating	
									P Stahl Steel	M Rostfrei Stainless	K Grauguss Grey cast iron	N NE-Metalle Non-ferrous metals	S Hochwarmfest High tempera- ture materials	H Harte Werkstoffe Hard materials	T Drehen Turning	M Fräsen Milling	D Bohren Drilling	S Gewinde- bearbeitung Threading		
BCP20M	HC-P20																			
BCP25M	HC-P25																			
	HC-M25																			
	HC-K25																			
BCP30M	HC-P30																			
BCP35M	HC-P35																			
	HC-M35																			
BCP40M	HC-P40																			
	HC-M40																			
BCM35M	HC-M35																			
	HC-P20																			
	HC-S30																			
BCM40M	HC-M40																			
BCK15M	HC-K15																			
BCK20M	HC-K20																			
	HC-P10																			

Anwendungsschwerpunkt
Application peak

Gesamtbereich nach ISO 513
Full range to ISO 513

Hauptanwendung
Main application

Weitere Anwendungen
Further applications

Standardsorte
Standard grade

Sortenbeschreibung siehe Seite 8
Grade description see page 9

Sortenübersicht Grade overview



Sorte Grade	ISO	Anwendungsbereich Application range	Werkstoffgruppe Material group						Bearbeitungsverfahren Application				Farbliche Darstellung der WSP je nach Beschichtung Color guide for inserts depending on coating	
			P Stahl Steel	M Rostfrei Stainless	K Grauguss Grey cast iron	N NE-Metalle Non-ferrous metals	S Hochwarmfest High tempera- ture materials	H Harte Werkstoffe Hard materials	T Drehen Turning	M Fräsen Milling	D Bohren Drilling	S Gewinde- bearbeitung Threading		
BCN10M	HC-N10					■								
	HC-S20						□				●			
	HC-M20			□										
BWN10M	HW-N10					■					●			
BCS35M	HC-S35							□			●			
	HC-M35			□										
BCS40M	HC-S40							□			●			
BCH05M	HC-H05								■					
	HC-P05		□								●			
	HC-K05		□		□									
BCH10M	HC-H10								■					
	HC-P10		□								●			
	HC-K10				□									
BCH13M	HC-H13								■		●			
BCH23M	HC-H23								■		●			
BCH30M	HC-H30								■					
	HC-P20		□								●			
	HC-K20				□									

Anwendungsschwerpunkt
Application peak

Gesamtbereich nach ISO 513
Full range to ISO 513

■ Hauptanwendung
Main application

□ Neben Anwendungen
Further applications

● Standardsorte
Standard grade

- **BCP20M (HC-P20) TERASpeed 2.0**

Härtere Alternative zur Sorte BCP25M mit HR-CVD Beschichtung, mit hohem Widerstand gegen Abrasivverschleiß. Ausgezeichnet geeignet für die Planfräsbearbeitung von Stahlmaterialien mit erhöhter Schnittgeschwindigkeit, unter stabilen Bedingungen und der wirtschaftlichen Trockenbearbeitung.

- **BCP25M (HC-P25/M25) Goldlox**

Mehrbereichssorte zum Fräsen von unlegiertem, niedrig legiertem, hoch legiertem und rostfreiem Stahl. Die PVD beschichtete Sorte eignet sich besonders für hohe Schnittgeschwindigkeiten bei der Trockenbearbeitung / Nassbearbeitung unter stabilen Bedingungen.

- **BCP30M (HC-P30) TERASpeed 2.0**

Universelle Stahlfräsorte vor allem zum Planfräsen. Hohe Bearbeitungssicherheit auf einem breiten Stahlwerkstoffspektrum wird durch das besonders zähe Hartmetallsubstrat garantiert. Eine moderne HR-CVD Beschichtung bietet wirtschaftliche Trockenbearbeitung bei hohen Schnittgeschwindigkeiten.

- **BCP35M (HC-P35/M35) Goldlox**

Universelle Stahlfräsorte in Kombination mit Anstellwinkel 90°. Eine PVD Schicht und eine zähe Hartmetallsorte zum Fräsen von den gängigen Stahlsorten. Besonders gut geeignet zum Trockenfräsen bei niedrigen bis mittleren Schnittgeschwindigkeiten unter schwierigen Bedingungen.

- **BCP40M (HC-P40/M40) Goldlox**

Eine PVD Schicht und zähe Hartmetallsorte zum Schruppen von vor allem Werkzeug-, Vergütungs-, Einsatzstählen und austenitisch, rostfreien Materialien.

- **BCM35M (HC-M35/P20/S30)**

Verschleißfeste PVD-Beschichtung, Feinkornsorte zur Bearbeitung von rostfreien und austenitisch rostfreien Materialien, zur Nass- und Trockenbearbeitung geeignet.

- **BCM40M (HC-M40)**

Extrem zähes, relativ feinkörniges Hartmetallsubstrat mit dünner, glatter PVD Beschichtung. Ideale Sorte zum Fräsen von austenitisch rostfreien Stählen und Werkstoffen aus der Duplexgruppe mit niedrigen bis mittleren Schnittgeschwindigkeiten. Auch für die Nassbearbeitung, jedoch wird Minimalmengenschmierung empfohlen.

- **BCK15M (HC-K15) TERASpeed 2.0**

Ausgesuchte Rohstoffe für ein optimiertes K15-Hartmetallsubstrat mit einer extrem harten und verschleißfesten HR-CVD Mehrlagen-Beschichtung. Ideal geeignet für die Trockenbearbeitung von Grauguss (GJL), Kugelgraphitguss (GJS), Temperguss und legiertem Guss.

- **BCK20M (HC-K20/P10)**

Zähes K20 Substrat und eine dicke PVD-Beschichtung für die Bearbeitung von Gussmaterialien. Auch als Schlichtsorte für die Stahlzerspanung und für die Bearbeitung von Kaltarbeitsstählen härter als 54 HRC geeignet.

- **BCN10M / (HC-N10/S20/M20)**

Ideale Sorte zur Bearbeitung von Aluminiumwerkstoffen mit Si-Gehalt > 6 % und weiteren NE-Metallen. Gefertigt nach dem Prinzip der unbeschichteten Sorte und in Kombination mit einer hauchdünnen PVD TiAlN-Schicht ist diese Sorte auch hervorragend zur Schlichtbearbeitung von Stählen, rostfreien Stählen und Graugussmaterialien zu verwenden.

- **BWN10M / (HW-N10)**

Nach höchsten Qualitätsvorgaben gefertigte, unbeschichtete Sorte zur Bearbeitung von NE-Metallen, Aluminium sowie Aluminiumlegierungen mit Si-Gehalt < 6 %. Sehr weiches Schnittverhalten dank speziell ausgelegter positiver Wendeplattengeometrie. Außerdem wird durch die Verwendung von Premium Sorten mit hoher Verschleißfestigkeit, gepaart mit hochpräzisen Fertigungstechnologien hinsichtlich Schärfe und Ausführung der Schneidkante, sowie glatter Schneidkante und mittels optimiertem Spanverhalten einer Aufbauschneidenbildung entgegen gewirkt.

- **BCS35M (HC-S35)**

Sorte mit ausgewogenem Härte-Zähigkeits-Verhältnis. Aufgrund der speziellen Zusammensetzung und Behandlung der Binderphase konnte die Warmhärte gesteigert werden, wodurch BCS35M besonders für die Bearbeitung von warmfesten Werkstoffen geeignet ist. Die besonders verschleißfeste Beschichtung weist eine geringe Affinität zu Titan auf, weshalb eine deutliche Reduktion von Materialanklebung erfolgt.

- **BCS40M (HC-S40)**

Eine zähe, bruchresistente Sorte mittlerer Härte. Die besondere Binderzusammensetzung reduziert chemischen Verschleiß, wodurch sie besonders für die Fräsbearbeitung von Ni-Basiswerkstoffen geeignet ist. Eine harte, verschleißfeste PVD-Beschichtung schützt das Werkzeug vor mechanischem Abtrag.

- **BCH05M**

Sorte zur Plan- und Konturbearbeitung von Stahlwerkstoffen mit HFC und R-Platten. HR-CVD beschichtet. Verschleißfestes Feinstkornhartmetall für breiten Anwendungsbereich, unter stabilen Bedingungen. Neuartige nanostrukturierte CVD Beschichtung mit hoher Warmhärte und Verschleißbeständigkeit.

- **BCH10M**

Sorte zur Bearbeitung von Stahlwerkstoffen im Bereich bis max. 58 HRC, PVD beschichtet. Standard-Feinstkornhartmetall mit mikrokristalliner, verschleißfester PVD Beschichtung.

- **BCH13M**

Für Schlichten und Semischlichten von Stahlwerkstoffen bis max. 62 HRC, bei stabilen und mäßig labilen Umfeldbedingungen. Hochverschleißfeste Ultrafeinkorn-Hartmetall Sorte mit einem hervorragenden Härte-/Biegefestigkeitsverhältnis. In Kombination mit einer extrem dichten, mikrokristallinen und verschleißfesten PVD Beschichtung, erfüllt diese Sorte höchste Performanceansprüche bei gleichzeitig hoher Prozesssicherheit.

- **BCH23M**

Zum Schlichten und Semischlichten von Werkstoffen bis max. 60 HRC. Zähes Ultrafeinkorn-Hartmetall für gute Verschleißbeständigkeit bei gleichzeitig guter Bruch- und Kantenstabilität. Verschleißfeste und temperaturbeständige PVD-Beschichtung.

- **BCH30M**

Universelle Sorte zur Bearbeitung der meisten gängigen Werkstoffen. Zähes Feinstkornhartmetall, bruch- und rissresistent bei gleichzeitig guter Verschleißbeständigkeit, breit einsetzbar. Mikrokristalline, spannungsoptimierte PVD-Beschichtung.

Grade description milling

- **BCP20M (HC-P20) TERAspeed 2.0**

Harder alternative to the BCP25M grade, with HR-CVD coating; high resistance to abrasive wear. Perfectly suited for face milling of steel materials at higher cutting speed under stable conditions and economic dry machining.

- **BCP25M (HC-P25/M25) Goldlox**

Multi purpose grade for milling unalloyed, low alloyed, high alloyed and stainless steel. The PVD coated grade is especially suitable for high cutting speeds on dry machining / wet machining under stable conditions.

- **BCP30M (HC-P30) TERAspeed 2.0**

Universal steel milling grade especially for face milling. The very tough carbide substrate guarantees high machining security on a wide range of steel materials. A modern HR-CVD coating ensures economic dry machining on high cutting speeds.

- **BCP35M (HC-P35/M35) Goldlox**

Universal steel milling grade in combination with 90° approach angle. A PVD layer and a tough carbide grade for milling of the most usual steel qualities. Especially good suitable for dry milling at low to medium cutting speeds under difficult conditions.

- **BCP40M (HC-P40/M40) Goldlox**

A PVD-layer and tough carbide grade for roughing of mainly tool, heat-treated and case-hardened steels, as well as austenitic, stainless materials.

- **BCM35M (HC-M35/P20/S30)**

Wear-resistant PVD coating, fine-grain grade for machining stainless and austenitic stainless materials; suitable for wet and dry machining.

- **BCM40M (HC-M40)**

Extremely tough, relative fine grained carbide substrate with thin, smooth PVD coating. Ideal grade for milling of austenitic stainless steels and materials from the Duplex group with low to medium cutting speeds. Also for wet machining, although minimum coolant supply is recommended.

- **BCK15M (HC-K15) TERAspeed 2.0**

Selected raw materials for an optimised K15 carbide substrate with a particularly hard and wear-resistant HR-CVD multilayer coating. Ideal for dry machining of grey cast iron (GJL), spheroidal graphite cast iron (GJS), tempered cast iron and alloyed cast iron.

- **BCK20M (HC-K20/P10)**

Tough K20 substrate and a thick PVD coating for the machining of cast materials. Also suited as finishing grade for steel cutting and the machining of cold work steels of 54 HRC.

- **BCN10M / (HC-N10/S20/M20)**

Ideal grade for machining aluminium materials with a Si content > 6 % and other non-ferrous materials. Produced according the principle of uncoated grades in combination with a very thin PVD TiAlN layer this grade is also excellent for finishing of steels, stainless steels and cast iron materials.

- **BWN10M / (HW-N10)**

Uncoated grade for machining non-ferrous materials, aluminium as well as aluminium alloys with Si content < 6 % produced according highest quality requirements. Very smooth cutting behaviour due to special designed positive insert geometry. Additionally through the application of premium grades with high wear resistance and due to high-precision production technologies regarding sharpness and design of the cutting edge as well as optimizes chip behaviour built-up edge formation is prevented.

- **BCS35M (HC-S35)**

BCS35M is a grade with a well-balanced hardness toughness relation. Because of its special composition and treatment of the binder phase, the high-temperature hardness is increased, which recommends BCS35M especially for machining of heat-resisting materials. The special wear-resistant coating exhibits little chemical affinity towards titanium, which causes a drastic reduction of material transfer from the work-piece to the cutting edge.

- **BCS40M (HC-S40)**

A tough, fracture-resistant grade of medium hardness. A special binder-composition reduces chemical wear, which makes the grade especially suitable for milling of Ni-based compounds. Mechanical wear is reduced by a hard, wear-resistant PVD-coating.

- **BCH05M**

Grade for face and contouring operations of steel materials with HFC and R inserts. HR-CVD coated. Wear resistant submicron grade for a wide range of application with stable conditions. New nanostructured CVD coating with high red hardness and wear resistance.

- **BCH10M**

Grade for the machining of steel materials in the area up to maximum 58 HRC, PVD coated. Standard submicron grade for microcrystalline, wear resistant PVD coating.

- **BCH13M**

For finishing and semi finishing of materials up to max. 62 HRC, at stable or moderate unstable conditions. High wear resistant ultrafine carbide grade with an excellent hardness/ bending ratio. Moreover this grade fulfils highest performance requirements compared to process secureness, through the usage of extreme tightly, microcrystalline and wear resistant PVD coating technology.

- **BCH23M**

For finishing and semifinishing of materials up to maximum 60 HRC. Tough ultrafine carbide grade for good wear resistance and at the same time good breakage and cutting edge stability. Wear and temperature resistant PVD coating.

- **BCH30M**

Universal grade for the machining of the most current materials. Tough submicron carbide grade, breakage and crack resistant and at the same time good wear resistance, wide application range. Microcrystalline, stress-optimised PVD coating.

ISO 45P



Anzahl Schneidkanten /
Wendeschneidplatte: 4
Number of cutting edges / insert: 4

Seite 54, see page 54

ETAtec 45P



Anzahl Schneidkanten /
Wendeschneidplatte: 7
Number of cutting edges / insert: 7
In INCH verfügbar / available in INCH
Seite 58, see page 58

THETAtec 45N



Anzahl Schneidkanten /
Wendeschneidplatte: 8
Number of cutting edges / insert: 8
In INCH verfügbar / available in INCH
Seite 62, see page 62

PItec 45N



Anzahl Schneidkanten /
Wendeschneidplatte: 16
Number of cutting edges / insert: 16
In INCH verfügbar / available in INCH
Seite 65, see page 65

KAPPAtec



Anzahl Schneidkanten /
Wendeschneidplatte: 10 ; 3, 4, 6
Number of cutting edges / insert: 10 ;
3, 4, 6
Seite 69, see page 69

BULLtec® 2.0 Serie



Anzahl Schneidkanten /
Wendeschneidplatte: 10 ; 3, 4, 6
Number of cutting edges / insert: 10 ;
3, 4, 6
Seite 71, see page 71

Fräsen Milling 90°

ISO 90P



Anzahl Schneidkanten /
Wendeschneidplatte: 2
Number of cutting edges / insert: 2
In INCH verfügbar / available in INCH
Seite 80, see page 80

BETAtec 90P Feed



Anzahl Schneidkanten /
Wendeschneidplatte: 2
Number of cutting edges / insert: 2
In INCH verfügbar / available in INCH
Seite 90, see page 90

DELTAtec 90P Feed



Anzahl Schneidkanten /
Wendeschneidplatte: 4
Number of cutting edges / insert: 4
In INCH verfügbar / available in INCH
Seite 103, see page 103

DELTAtec 90N



Anzahl Schneidkanten /
Wendeschneidplatte: 4
Number of cutting edges / insert: 4
Seite 116, see page 116

DELTAtec 90N Tang



Anzahl Schneidkanten /
Wendeschneidplatte: 4
Number of cutting edges / insert: 4
Seite 120, see page 120

ZETAtec 90N

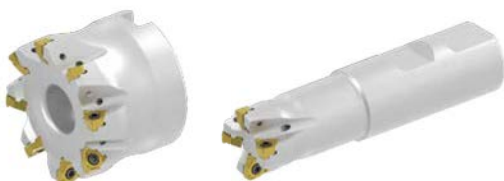

Anzahl Schneidkanten /
Wendeschneidplatte: 6
Number of cutting edges / insert: 6
In INCH verfügbar / available in INCH
Seite 124, see page 124

THETAtec 88N



Anzahl Schneidkanten /
Wendeschneidplatte: 8
Number of cutting edges / insert: 8
Seite 128, see page 128

Fräsen Milling 3D

BALLtec / TORROtec



Anzahl Schneidkanten /
Wendeschneidplatte: 2
Number of cutting edges / insert: 2

Seite 134, see page 134

RHOMBICtec 95P



Anzahl Schneidkanten /
Wendeschneidplatte: 2
Number of cutting edges / insert: 2

Seite 149, see page 149

ISO Plunge 90P



Anzahl Schneidkanten /
Wendeschneidplatte: 2
Number of cutting edges / insert: 2

Seite 152 see page 152

ISO 00P



Anzahl Schneidkanten /
Wendeschneidplatte: variabel
Number of cutting edges / insert: various
In INCH verfügbar / available in INCH
Seite 154, see page 154

VARIOtec 00P



Anzahl Schneidkanten /
Wendeschneidplatte: variabel
Number of cutting edges / insert: various

Seite 169, see page 169

Fräsen Milling 45°

ISO Chamfer



Anzahl Schneidkanten /
Wendeschneidplatte: 3
Number of cutting edges / insert: 3

Seite 50, see page 50

Vollhartmetall Fräser / Solid carbide end milling cutter



Zähne 2, 3, 4, 5, 6, 8
Teeth 2, 3, 4, 5, 6, 8

Seite 177, see page 177

Verlängerungen, Aufnahmen Extensions, Chucks

Verlängerungen Extensions



Vollhartmetallverlängerungen
Solid carbide extensions

Seite 294, see page 294

Aufnahmen Chucks



Werkzeugaufnahmen
Tool clamping

Seite 298, see page 298

Fräserbezeichnung Wendepplattenfräser
Cutter designation system indexable milling cutter

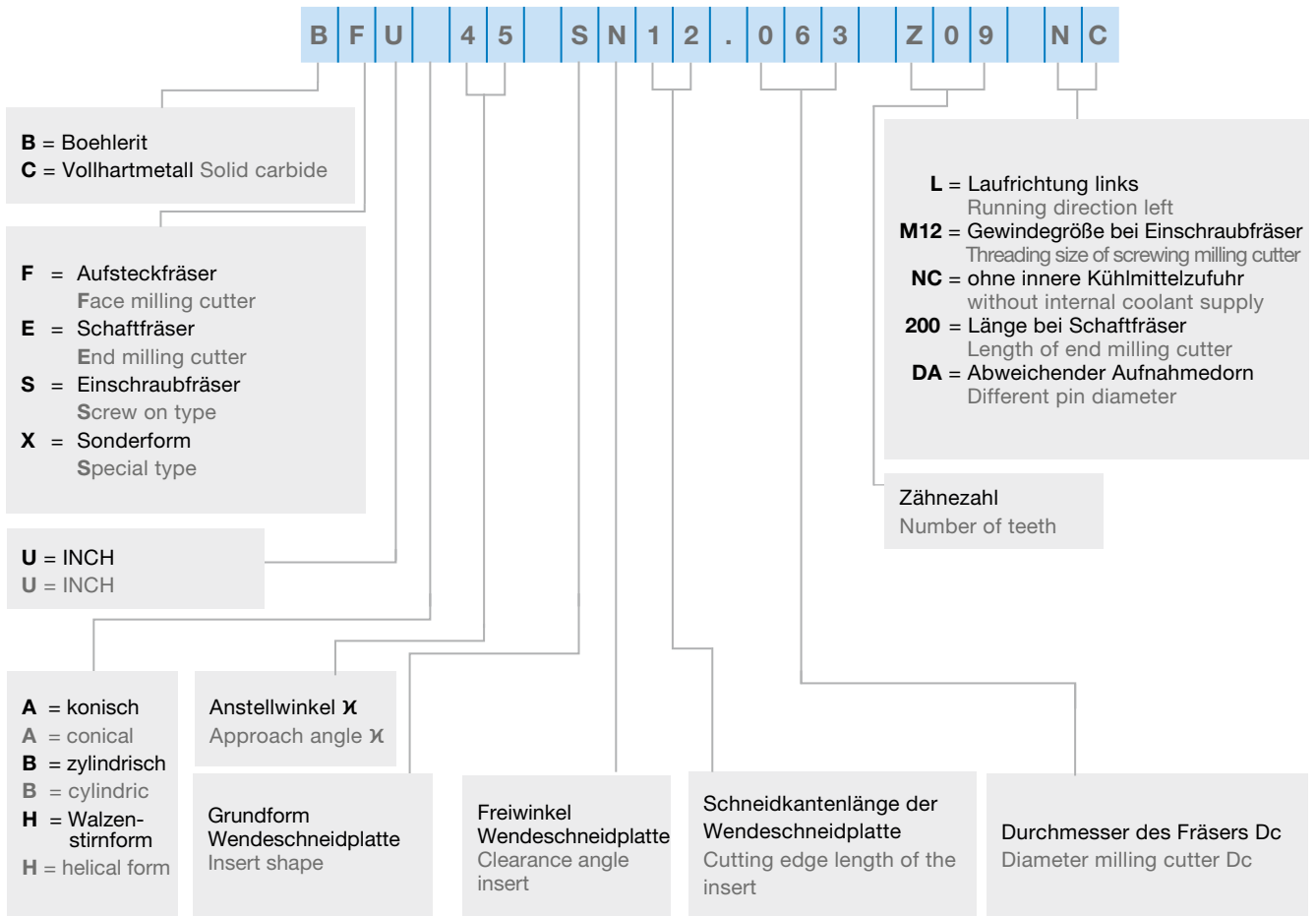

Bezeichnungssystem
Designation system

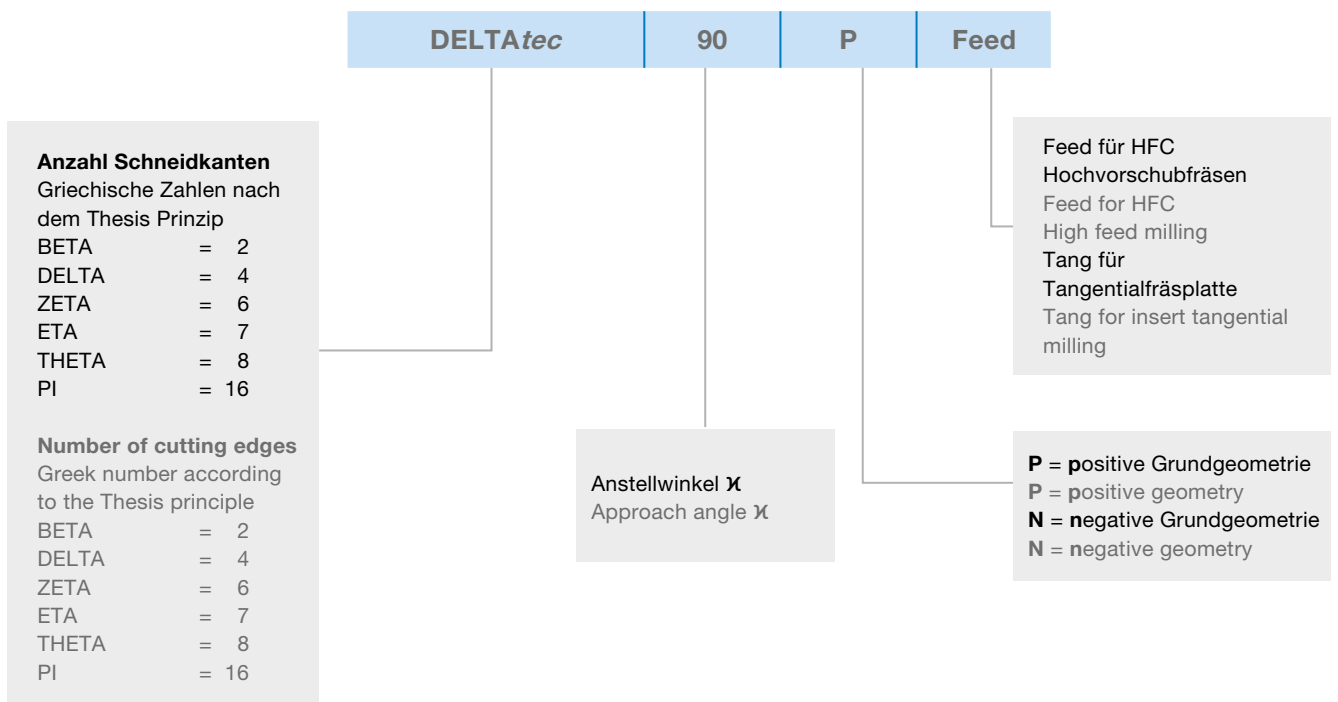

Schneidstoffsorten, Bezeichnung für Wendschneidplatten
Cutting materials, designation system for indexable inserts

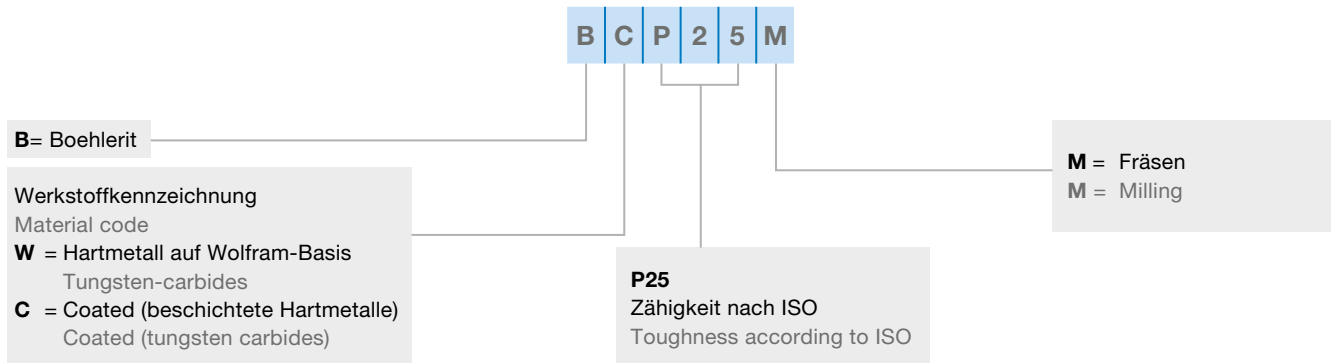

Vollhartmetall-Verlängerungen, Bezeichnung
Solid carbide extensions, designation system

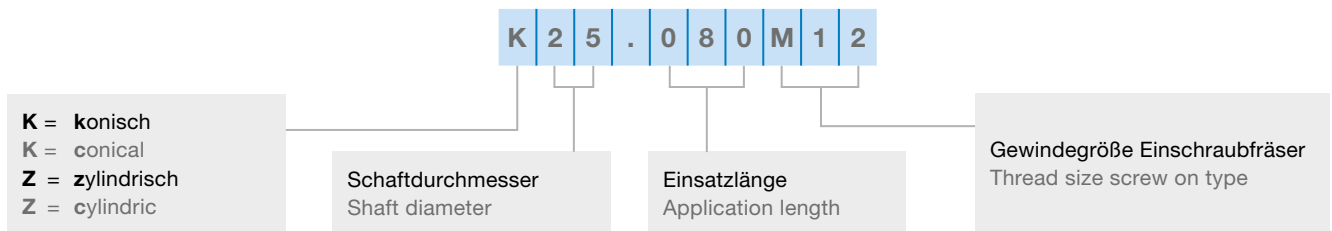

Fräsbezeichnung für Vollhartmetallfräser
Cutter designation system for solid carbide milling tools

U P H 0 6 . 0 1 3 . 0 8 0 S H Z 6 H A B

Systembezeichnung *
System designation *

Schneidkreisdurchmesser
Diameter cutter

Einsatzlänge Fräser
Application length
milling cutter

Gesamtlänge
Total length

Zähnezahl
Amount of teeth

HA/HB = Schaft Shank
A = konisch conical
B = zylindrisch cilindric
LS = Langer Schaft
Long shank
SF = Super finish

Cx = Schneidkantenfase 45° Cutting edge chamfer 45°
Cr = Schneidkantenradius Cutting edge corner radius
SH = Schneidkante scharf Cutting edge sharp
FR = Eckenradius definiert Corner radius defined

*** Systembezeichnung**
*** System designation**

U.. Unitec	BCU Balltec SC Universal
UN Unitec N	BCH Balltec SC Hardened
UC Unitec Chamfer	BCN Balltec SC N
UP. Unitec Pro	BCG Balltec SC Graphite
UPN Unitec Pro N	
UPH Unitec Pro H	TCU Torrotec SC Universal
	TCH Torrotec SC Hardened
MU Multitec	
MUN Multitec N	FCU Feedtec SC Universal
	FCH Feedtec SC Hardened
T Trochotec	
TP Trochotec PM	
TS Trochotec S	
TT Trochotec T	
TH Trochotec TH	

Symbolerklärung für Fräsoperationen
Symbols for milling operations

Planfräsen Face milling		Tauchfräsen Plunge milling	
Gassenfräsen Pocket milling		Zirkularfräsen Helical ramping	
Eckfräsen Edge milling		Taschenfräsen Pocketing	
Nutfräsen Slot milling		Rampe eintauchen Linear ramping	
Besäumen Trimming		Kopierfräsen Copy milling	
Trochoidales Fräsen Trochoidal milling		Fasen Chamfering	

Symbolerklärung für Fräsoptionen Vollhartmetallfräser
Symbols for milling operations solid carbide milling tools

Schutzfase 45° Chamfer 45°	Cx	Standard Linie Standard line		
Schutzradius nicht genormt Radius not standardized	Cr	Professional Linie Professional line		
Scharfe Schneide Sharp edge	SH	Schaftausführung Shank type		
Radius definiert Radius standardized	FR	Ungleichteilung Unequal division		
Ausführung 2xD Execution 2xD	2xD	Ungleiche Drillwinkel Unequal helix angle		
Ausführung 3xD Execution 3xD	3xD	Eintauchwinkel Ramping angle		
Ausführung 5xD Execution 5xD	5xD	Toleranzklassifizierung Tolerance classification		

S	N	M	X	12			
Grundform Insert shape	Freiwinkel Clearance angle	Toleranzen Tolerances	Spanformer, Befestigung Chip breaker, fixation	Schneidenlänge Cutting edge length			
A		m		l			
B		A ±0,005			s ±0,025	d ±0,025	06 6,350
C		C ±0,013			s ±0,025	d ±0,025	07 7,938
D		E ±0,025			s ±0,025	d ±0,025	09 9,525
E		F ±0,005			s ±0,025	d ±0,013	11 11,000
H		G ±0,025			s ±0,13	d ±0,025	12 12,700
K		H ±0,013			s ±0,025	d ±0,013	15 15,875
L		J ±0,005			s ±0,025	d siehe see Tab. 4	16 16,500
M		K ±0,013			s ±0,025	d siehe see Tab. 4	19 19,050
O		L ±0,025			s ±0,025	d siehe see Tab. 4	22 22,000
P	M siehe see Tab. 5	s ±0,13	d siehe see Tab. 4	25 25,400			
R	N siehe see Tab. 5	s ±0,025	d siehe see Tab. 4	31 31,750			
S	0°	U siehe see Tab. 5	s ±0,13	d siehe see Tab. 4			
T	A 3°	Tab. 4		38 38,100			
V	B 5°	d					
W	C 7°	J, K, L, M					
	D 15°	U					
	E 20°	d					
	F 25°	über					
	G 30°	bis					
	N 0°	3,9 10,0 ±0,05 ±0,08					
	P 11°	10,0 15,0 ±0,08 ±0,13					
	O	15,0 20,0 ±0,10 ±0,18					
		20,0 26,0 ±0,13 ±0,25					
		26,0 32,0 ±0,15 ±0,25					
		Tab. 5					
		d					
		über					
		bis					
		3,9 10,0 ±0,08 ±0,13					
		10,0 15,0 ±0,13 ±0,20					
		15,0 20,0 ±0,15 ±0,27					
		20,0 26,0 ±0,18 ±0,38					
		26,0 32,0 ±0,20 ±0,38					
		Eckenrundung, ungerade Seitenzahl					
		Corner rounding uneven number of sides					
		Eckenrundung, gerade Seitenzahl					
		Corner rounding, even number of sides					
		Fasenplatten					
		Chamfered inserts					
		Der Eckenwinkel ist bei ungleichwinkligen Grundformen immer der kleinere Winkel.					
		The corner angle is in the case of not equiangular basic forms always the smaller angle.					
		Normalfreiwinkel, die eine besondere Beschreibung erfordern.					
		Normal clearance angles, which require a special description.					
		X mit Besonderheit nach Zeichnung					
		with special feature according to drawing					

() Kegelwinkel für Schraube
() Cone angle for screw

06	AN	S	N	- MP
Schneidkanten Höhe Cutting edges height	Schneidenecke Cutting edge corner	Schneiden- ausführung ¹⁾ Cutting edge type ¹⁾	Schneidrichtung ¹⁾ Direction of cut ¹⁾	Boehlerit-Norm Boehlerit-Standard
	Für Radiusplatten For radius inserts 		R 	
S	Eckradius-r Corner radius-r	scharfkantig sharp-edged	nur rechtsschneidend right hand cut only	Geometrie Bezeichnung Geometry code
02 2,38	00 scharfkantig sharp-edged		L 	
03 3,18	02 0,2	gerundet rounded	nur linksschneidend left hand cut only	
T3 3,97	04 0,4		N 	
04 4,76	08 0,8	gefäst chamfered	rechts- und links- schneidend right and left hand cut	
05 5,56	12 1,2			
06 6,35	16 1,6	gefäst und gerundet * chamfered and rounded *		
07 7,94	20 2,0			
08 8,00	usw. etc.	doppelgefäst double chamfered	¹⁾ Die Anwendung dieser Kennbuch- staben ist freigestellt. The use of these reference letters is optional.	
09 9,52	Für Fasenplatten Planschneiden For chamfered inserts face milling 			
Abmessungen in mm Dimensions in mm	Anstellwinkel Approach angle	doppelgefäst und gerundet * double chamfered and rounded *		Beispiel:
	X _r	Freiwinkel der Planschneide Clearance angle of face milling edge α _n		S N M X 12 06 AN S N-MP
A 45°	D 60°	A 3°		# 1 2 3 4 5 6 7 8 9 10
E 75°	F 85°	B 5°		1 Grundform quadratisch
P 90°	Z Sonder Special	C 7°		2 Freiwinkel 0°
Z Sonder Special	Rundwende- platte metrisch Round insert metric	D 15°		3 Toleranzen m ± 0,013 s ± 0,025 d ± 0,13
MO	Rundwende- platte Zoll Round insert Inch	E 20°		4 Befestigung Spanfläche mit Besonderheit nach Zeichnung
OO		F 25°		5 Schneidenecke 12,7
		G 30°		6 Dicke 6,35
		N 0°		7 Schneidenecke 45° Fase/Freiwinkel
		P 11°		8 Schneidenecke gerundet*
		Z Sonder Special		9 Schneidenecke rechts- und linksschneidend
		MO Rundwende- platte metrisch Round insert metric		10 Schneidrichtung rechts- und linksschneidend
		OO Rundwende- platte Zoll Round insert Inch		10 Interne Bezeichnung MP = Geometrie
				Example:
				1 Basic form square
				2 Clearance angle 0°
				3 Tolerances m ± 0.013 s ± 0.025 d ± 0.13
				4 Fixing cutting face with special feature according to drawing
				5 Length of cutting edge 12.7
				6 Thickness 6,35
				7 Cutting edge corner 45° chamfer/clearance angle
				8 Cutting edge rounded*
				9 Direction of cut right- and lefthand
				10 Internal designation MP = Geometry

BALLtec

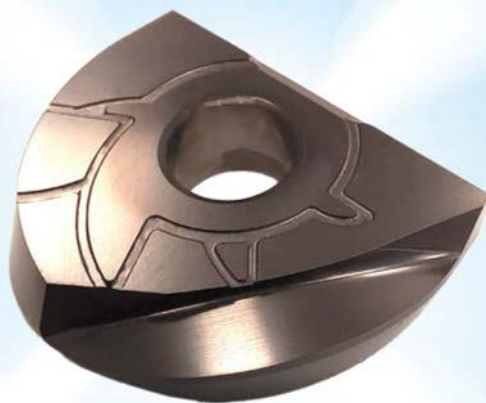









- Multifunktionales Werkzeugsystem für hohe Präzision und Prozesssicherheit
- Multifunctional tool system for high precision and process reliability

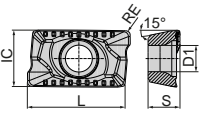

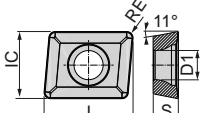
Wendeschneidplatten Indexable inserts

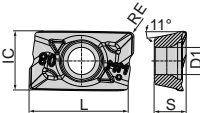

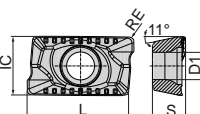



Wendeschneidplatten
Indexable inserts

CEDC = Anzahl der Schneidkanten CEDC = Number of cutting edges	Artikelbezeichnung Item code	Schneidstoffsorte Cutting materials	Bestell-Nr. Ordering No.	Verfügbarkeit Availability	Abmessungen [mm] Dimensions [mm]					Werkzeuge Tools
					L	IC	S	D1	RE	
  CEDC = 2	ADKX 110308 SR-TR	BCP35M	5100445	○	11,9	7,9	3,47	3,4	0,8	
  CEDC = 2	APET 150412 SN-MP	BCP35M	5153562	○	15,875	12,70	4,76	5,5	1,2	
  CEDC = 2	APHT 100304 FR-MN	BCN10M	5092189	●	10	6,7	3,5	2,8	0,4	
	APHT 100304 FR-MN	BWN10M	5092191	●	10	6,7	3,5	2,8	0,4	
	APHT 160408 FR-MN	BCN10M	5092182	●	16	9,6	5,26	4,4	0,8	
	APHT 160408 FR-MN	BWN10M	5092188	●	16	9,6	5,26	4,4	0,8	
  CEDC = 2	APKT 1003 PDSR-BP	BCP25M	5080850	●	10	6,7	3,5	3,08	0,5	
	APKT 1003 PDSR-BP	BCP30M	5080852	●	10	6,7	3,5	3,08	0,5	
	APKT 1003 PDSR-BP	BCP35M	5080854	●	10	6,7	3,5	3,08	0,5	
	APKT 1003 PDSR-BM	BCM40M	5080847	●	10	6,7	3,5	3,08	0,5	
	APKT 1003 PDSR-BP	BCK15M	5080855	●	10	6,7	3,5	3,08	0,5	
	APKT 1003 PDSR-BP	BCK20M	5081942	●	10	6,7	3,5	3,08	0,5	
	APKT 1604 PDSR-BP	BCP25M	5079677	●	16	9,52	5,26	4,5	0,8	
	APKT 1604 PDSR-BP	BCP30M	5079680	●	16	9,52	5,26	4,5	0,8	
	APKT 1604 PDSR-BP	BCP35M	5079683	●	16	9,52	5,26	4,5	0,8	
	APKT 1604 PDSR-BM	BCM40M	5079687	●	16	9,52	5,26	4,5	0,8	
	APKT 1604 PDSR-BP	BCK15M	5079689	●	16	9,52	5,26	4,5	0,8	
	APKT 160416 SR-BP	BCP30M	5080870	●	16	9,52	5,26	4,5	1,6	
	APKT 160416 SR-BP	BCP35M	5125093	●	16	9,52	5,26	4,5	1,6	
	APKT 160424 SR-BP	BCP30M	5080872	●	16	9,52	5,26	4,5	2,4	
	APKT 160424 SR-BP	BCP35M	5125092	○	16	9,52	5,26	4,5	2,4	
APKT 160432 SR-BP	BCP30M	5080873	●	16	9,52	5,26	4,5	3,2		
APKT 160432 SR-BP	BCP35M	5125095	○	16	9,52	5,26	4,5	3,2		

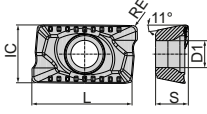
Bestellbeispiel Order example: 10 Stück pieces 5100445 oder or ADKX 110308 SR-TR BCP35M

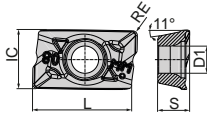
Farbliche Abbildung der WSP müssen nicht dem Original entsprechen!
Colours of the original indexable inserts may deviate from the illustration!

CEDC = Anzahl der Schneidkanten CEDC = Number of cutting edges	Artikelbezeichnung Item code	Schneidstoffsorte Cutting materials	Bestell-Nr. Ordering No.	Verfügbarkeit Availability	Abmessungen [mm] Dimensions [mm]					Werkzeuge Tools
					L	IC	S	D1	RE	
  CEDC = 2	APKT 15T3 PDTR-BP	BCP30M	5080857	○	15	9,73	4,5	4,5	0,8	
	APKT 15T3 PDTR-BP	BCP35M	5080858	○	15	9,73	4,5	4,5	0,8	
  CEDC = 2	APKT 100304 SR-MP2	BCP25M	5085192	●	10	6,7	3,5	2,8	0,4	ISO 90 P Seite, see page 80
	APKT 100304 SR-MP2	BCP35M	5085190	●	10	6,7	3,5	2,8	0,4	
	APKT 100304 SR-MM2	BCM40M	5085158	●	10	6,7	3,5	2,8	0,4	
	APHT 100304 FR-MN2	BCN10M	5092158	●	10	6,7	3,5	2,8	0,4	
	APHT 100304 FR-MN2	BWN10M	5092159	●	10	6,7	3,5	2,8	0,4	
	APKT 100304 SR-RP2	BCP30M	5092141	●	10	6,7	3,5	2,8	0,4	
	APKT 100304 SR-RP2	BCP35M	5085194	●	10	6,7	3,5	2,8	0,4	
	APKT 100304 SR-RP2	BCP40M	5092143	●	10	6,7	3,5	2,8	0,4	
	APKT 100304 SR-RK2	BCK15M	5092144	●	10	6,7	3,5	2,8	0,4	
	APKT 100304 SR-RK2	BCK20M	5085202	●	10	6,7	3,5	2,8	0,4	
	APKT 160408 SR-MP2	BCP25M	5085147	●	16	9,6	5,26	4,4	0,8	
	APKT 160408 SR-MP2	BCP35M	5085140	●	16	9,6	5,26	4,4	0,8	
	APKT 160408 SR-MM2	BCM40M	5080859	●	16	9,6	5,26	4,4	0,8	
	APHT 160408 FR-MN2	BCN10M	5092154	●	16	9,6	5,26	4,4	0,8	
	APHT 160408 FR-MN2	BWN10M	5092155	●	16	9,6	5,26	4,4	0,8	
	APKT 160408 SR-RP2	BCP30M	5092136	●	16	9,6	5,26	4,4	0,8	
APKT 160408 SR-RP2	BCP35M	5085148	●	16	9,6	5,26	4,4	0,8		
APKT 160408 SR-RP2	BCP40M	5092137	●	16	9,6	5,26	4,4	0,8		
APKT 160408 SR-RK2	BCK15M	5092140	●	16	9,6	5,26	4,4	0,8		
APKT 160408 SR-RK2	BCK20M	5085153	●	16	9,6	5,26	4,4	0,8		

Bestellbeispiel Order example: 10 Stück pieces 5080857 oder or APKT 15T3 PDTR-BP BCP30M

Schnittwertempfehlungen Fräser 90° siehe Seite 130

Cutting data recommendations milling cutter 90°, see page 130

Sortenübersicht Seite 6

Grade overview, see page 6

- Verfügbar ab Lager Available from stock
- Lieferzeit auf Anfrage Delivery time on request

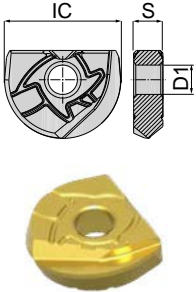
CEDC = Anzahl der Schneidkanten CEDC = Number of cutting edges	Artikelbezeichnung Item code	Schneidstoffsorte Cutting materials	Bestell-Nr. Ordering No.	Verfügbarkeit Availability	Abmessungen [mm] Dimensions [mm]			Werkzeuge Tools
					IC	S	D1	
 <p>CEDC = 2</p>	BE12-SHF	BCH10M	5117378	●	12	2,99	3,5	BALLtec Seite, see page 134
	BE12-SHF	BCH23M	5117382	○	12	2,99	3,5	
	BE12-MHF	BCH30M	5117384	●	12	2,99	3,5	
	BE16-SHF	BCH10M	5117356	●	16	3,99	4	
	BE16-SHF	BCH23M	5117364	●	16	3,99	4	
	BE16-MHF	BCH30M	5117365	●	16	3,99	4	
	BE20-SHF	BCH10M	5117681	●	20	4,99	5	
	BE20-SHF	BCH23M	5117682	●	20	4,99	5	
	BE20-MHF	BCH30M	5117683	●	20	4,99	5	
	BE25-SHF	BCH10M	5117684	○	25	5,99	6	
	BE25-SHF	BCH23M	5117485	○	25	5,99	6	
	BE25-MHF	BCH30M	5117488	●	25	5,99	6	
	BE32-SHF	BCH10M	5117494	●	32	6,99	8	
	BE32-SHF	BCH23M	5117496	○	32	6,99	8	
	BE32-MHF	BCH30M	5117499	○	32	6,99	8	



Bestellbeispiel Order example: 10 Stück pieces 5117377 oder or BE12-FHF BCH03M

Schnittwertempfehlungen 3D Fräsen siehe Seite 174

Cutting data recommendations 3D milling, see page 174

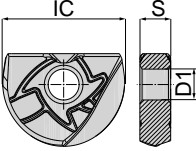
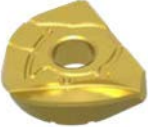
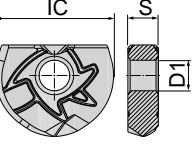

Farbliche Abbildung der WSP müssen nicht dem Original entsprechen!

Colours of the original indexable inserts may deviate from the illustration!

CEDC = Anzahl der Schneidkanten CEDC = Number of cutting edges	Artikelbezeichnung Item code	Schneidstoffsorte Cutting materials	Bestell-Nr. Ordering No.	Verfügbarkeit Availability	Abmessungen [mm] Dimensions [mm]			Werkzeuge Tools
					IC	S	D1	
  CEDC = 2	BE08-FHF2	BCH13M	5155325	●	8	2,39	2,5	BALLtec Seite, see page 134
	BE10-FHF2	BCH13M	5155327	●	10	2,59	3	
	BE12-FHF2	BCH13M	5155330	●	12	2,99	3,5	
	BE16-FHF2	BCH13M	5154846	●	16	3,99	4	
	BE20-FHF2	BCH13M	5155331	●	20	4,99	5	
	BE25-FHF2	BCH13M	5168770	●	25	5,99	6	
	BE32-FHF2	BCH13M	5165828	●	32	6,99	8	
  CEDC = 2	BE08-MHN2	BCH10M	5133146	●	8	2,39	2,5	
	BE08-SHN2	BCH23M	5133147	●	8	2,39	2,5	
	BE08-MHN2	BCH30M	5133148	●	8	2,39	2,5	
	BE10-MHN2	BCH10M	5133149	●	10	2,59	3	
	BE10-SHN2	BCH23M	5133150	●	10	2,59	3	
	BE10-MHN2	BCH30M	5133151	●	10	2,59	3	
	BE12-MHN2	BCH10M	5131970	●	12	2,99	3,5	
	BE12-SHN2	BCH23M	5131971	●	12	2,99	3,5	
	BE12-MHN2	BCH30M	5131973	○	12	2,99	3,5	
	BE16-FHN2	BCH13M	5131967	●	16	3,99	4	
	BE16-MHN2	BCH10M	5131975	●	16	3,99	4	
	BE16-SHN2	BCH23M	5131976	○	16	3,99	4	
	BE16-MHN2	BCH30M	5131977	○	16	3,99	4	
	BE20-MHN2	BCH10M	5133152	●	20	4,99	5	
	BE20-SHN2	BCH23M	5133153	○	20	4,99	5	
	BE20-MHN2	BCH30M	5133154	●	20	4,99	5	
	BE25-MHN2	BCH10M	5133155	○	25	5,99	6	
	BE25-SHN2	BCH23M	5133156	○	25	5,99	6	
	BE25-MHN2	BCH30M	5133157	●	25	5,99	6	
	BE32-MHN2	BCH10M	5144243	○	32	6,99	8	
	BE32-SHN2	BCH23M	5144244	○	32	6,99	8	
BE32-MHN2	BCH30M	5144245	○	32	6,99	8		

Bestellbeispiel Order example: 10 Stück pieces 5155325 oder or BE08-FHF2 BCH13M
 Schnittwertempfehlungen 3D Fräsen siehe Seite 174
 Cutting data recommendations 3D milling, see page 174
 Sortenübersicht Seite 6
 Grade overview, see page 6

● Verfügbar ab Lager Available from stock
 ○ Lieferzeit auf Anfrage
 Delivery time on request

CEDC = Anzahl der Schneidkanten CEDC = Number of cutting edges	Artikelbezeichnung Item code	Schneidstoffsorte Cutting materials	Bestell-Nr. Ordering No.	Verfügbarkeit Availability	Abmessungen [INCH] Dimensions [INCH]			Werkzeuge Tools
					IC	S	D1	
 <p>CEDC = 2</p>	BE0312-SHF	BCH10M	5151437	○	0.312	0.094	0.098	BALLtec Seite, see page 134
	BE0312-SHF	BCH23M	5151438	○	0.312	0.094	0.098	
	BE0312-MHF	BCH30M	5151439	○	0.312	0.094	0.098	
	BE0375-SHF	BCH10M	5151443	●	0.375	0.100	0.118	
	BE0375-SHF	BCH23M	5151444	●	0.375	0.100	0.118	
	BE0375-MHF	BCH30M	5151445	○	0.375	0.100	0.118	
	BE0500-SHF	BCH10M	5151454	●	0.500	0.118	0.138	
	BE0500-SHF	BCH23M	5151455	●	0.500	0.118	0.138	
	BE0500-MHF	BCH30M	5151456	○	0.500	0.118	0.138	
	BE0625-SHF	BCH10M	5151462	○	0.625	0.157	0.157	
	BE0625-SHF	BCH23M	5151463	○	0.625	0.157	0.157	
	BE0625-MHF	BCH30M	5151464	○	0.625	0.157	0.157	
	BE0750-SHF	BCH10M	5147176	●	0.750	0.196	0.196	
	BE0750-SHF	BCH23M	5147177	○	0.750	0.196	0.196	
	BE0750-MHF	BCH30M	5147178	○	0.750	0.196	0.196	
	BE1000-SHF	BCH10M	5151469	●	1.000	0.236	0.236	
	BE1000-SHF	BCH23M	5151470	●	1.000	0.236	0.236	
	BE1000-MHF	BCH30M	5151471	○	1.000	0.236	0.236	
BE1250-SHF	BCH10M	5151475	○	1.250	0.275	0.315		
BE1250-SHF	BCH23M	5151476	○	1.250	0.275	0.315		
BE1250-MHF	BCH30M	5151477	○	1.250	0.275	0.315		
 <p>CEDC = 2</p>	BE0312-FHF2	BCH13M	5156144	○	0.312	0.094	0.098	
	BE0375-FHF2	BCH13M	5156147	○	0.375	0.100	0.118	
	BE0500-FHF2	BCH13M	5156148	○	0.500	0.118	0.138	
	BE0625-FHF2	BCH13M	5156160	○	0.625	0.157	0.157	
	BE0750-FHF2	BCH13M	5156161	○	0.750	0.196	0.196	

Bestellbeispiel Order example: 10 Stück pieces 5151437 oder or BE0312-SHF BCH10M

Schnittwertempfehlungen 3D Fräsen siehe Seite 174

Cutting data recommendations 3D milling, see page 174

Farbliche Abbildung der WSP müssen nicht dem Original entsprechen!

Colours of the original indexable inserts may deviate from the illustration!

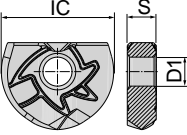
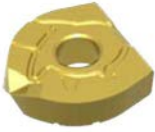
CEDC = Anzahl der Schneidkanten CEDC = Number of cutting edges	Artikelbezeichnung Item code	Schneidstoffsorte Cutting materials	Bestell-Nr. Ordering No.	Verfügbarkeit Availability	Abmessungen [INCH] Dimensions [INCH]			Werkzeuge Tools
					IC	S	D1	
  CEDC = 2	BE0312-MHN2	BCH10M	5151440	○	0.312	0.094	0.098	BALLtec Seite, see page 134
	BE0312-SHN2	BCH23M	5151441	○	0.312	0.094	0.098	
	BE0312-MHN2	BCH30M	5151442	○	0.312	0.094	0.098	
	BE0375-MHN2	BCH10M	5151447	●	0.375	0.10	0.118	
	BE0375-SHN2	BCH23M	5151448	●	0.375	0.10	0.118	
	BE0375-MHN2	BCH30M	5151449	○	0.375	0.10	0.118	
	BE0500-MHN2	BCH10M	5151458	●	0.500	0.118	0.138	
	BE0500-SHN2	BCH23M	5151459	●	0.500	0.118	0.138	
	BE0500-MHN2	BCH30M	5151460	○	0.500	0.118	0.138	
	BE0625-MHN2	BCH10M	5151466	○	0.625	0.157	0.157	
	BE0625-SHN2	BCH23M	5151467	○	0.625	0.157	0.157	
	BE0625-MHN2	BCH30M	5151468	○	0.625	0.157	0.157	
	BE0750-MHN2	BCH10M	5147179	○	0.750	0.196	0.196	
	BE0750-SHN2	BCH23M	5147180	○	0.750	0.196	0.196	
	BE0750-MHN2	BCH30M	5147181	○	0.750	0.196	0.196	
	BE1000-MHN2	BCH10M	5151472	●	1.000	0.236	0.236	
	BE1000-SHN2	BCH23M	5151473	●	1.000	0.236	0.236	
	BE1000-MHN2	BCH30M	5151474	○	1.000	0.236	0.236	
	BE1250-MHN2	BCH10M	5151478	○	1.250	0.275	0.315	
	BE1250-SHN2	BCH23M	5151479	○	1.250	0.275	0.315	
	BE1250-MHN2	BCH30M	5151480	○	1.250	0.275	0.315	

Bestellbeispiel Order example: 10 Stück pieces 5151440 BE0312-MHN2 BCH10M
 Schnittwertempfehlungen 3D Fräsen siehe Seite 174
 Cutting data recommendations 3D milling, see page 174
 Sortenübersicht Seite 6
 Grade overview, see page 6

● Verfügbar ab Lager Available from stock
 ○ Lieferzeit auf Anfrage
 Delivery time on request

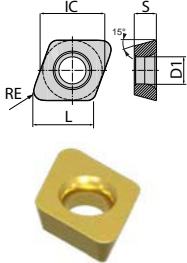
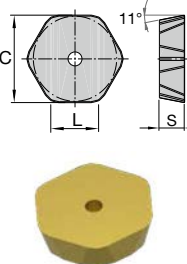
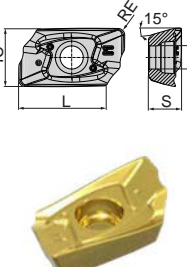
CEDC = Anzahl der Schneidkanten CEDC = Number of cutting edges	Artikelbezeichnung Item code	Schneidstoffsorte Cutting materials	Bestell-Nr. Ordering No.	Verfügbarkeit Availability	Abmessungen [mm] Dimensions [mm]					Werkzeuge Tools
					L	IC	S	D1	RE	
 <p>CEDC = 2</p>	CDGX 060210 SR-FH	BCH10M	5117603	●	5,8	6,5	2,38	2,9	1	RHOMBICtec 95P Seite, see page 149
	CDGX 060210 SR-FH	BCH23M	5117604	●	5,8	6,5	2,38	2,9	1	
	CDGX 060210 SR-FH	BCH30M	5117605	●	5,8	6,5	2,38	2,9	1	
	CDGX 060210 SR-FW	BCH10M	5117608	●	1,72	6,5	2,38	2,9	1	
 <p>CEDC = 6</p>	HPKN 1206 ADSN	BCP30M	5138418	○	12,7	22	6,35	-	-	BULLtec Seite, see page 71
	HPKN 1206 ADSN	BCP35M	5138419	●	12,7	22	6,35	-	-	
	HPKN 1206 ADSN	BCP40M	5133930	●	12,7	22	6,35	-	-	
	HPKN 1206 ADSN	BCM40M	5142231	●	12,7	22	6,35	-	-	
	HPKN 1206 ADSN	BCK20M	5192090	●	12,7	22	6,35	-	-	
 <p>CEDC = 2</p>	90° Platten/90° inserts									
	LDMX 100404 SR-MP	BCP25M	5145449	●	10	7,0	4,0	2,8	0,4	BETAtec 90P Feed Seite, see page 90
	LDMX 100404 SR-MP	BCP35M	5145447	●	10	7,0	4,0	2,8	0,4	
	LDMX 100404 SR-MM	BCM35M	5145450	●	10	7,0	4,0	2,8	0,4	
	LDMX 100404 SR-MM	BCM40M	5145452	●	10	7,0	4,0	2,8	0,4	
	LDHX 100404 FR-MN	BCN10M	5141477	●	10	7,0	4,0	2,8	0,4	
	LDHX 100404 FR-MN	BWN10M	5141470	●	10	7,0	4,0	2,8	0,4	
	LDMX 100408 SR-MP	BCP25M	5081948	●	10	7,0	4,0	2,8	0,8	
	LDMX 100408 SR-MP	BCP35M	5081947	●	10	7,0	4,0	2,8	0,8	
	LDMX 100408 SR-MP	BCP40M	5092193	●	10	7,0	4,0	2,8	0,8	
	LDMX 100408 SR-MM	BCM35M	5092296	●	10	7,0	4,0	2,8	0,8	
	LDMX 100408 SR-MM	BCM40M	5081950	●	10	7,0	4,0	2,8	0,8	
	LDMX 100408 SR-MK	BCK20M	5081949	●	10	7,0	4,0	2,8	0,8	
	LDHX 100408 FR-MN	BCN10M	5141479	●	10	7,0	4,0	2,8	0,8	
	LDHX 100408 FR-MN	BWN10M	5141478	●	10	7,0	4,0	2,8	0,8	
	LDMX 100408 SR-MS	BCS35M	5125069	●	10	7,0	4,0	2,8	0,8	
	LDMX 100408 SR-MS	BCS40M	5168099	●	10	7,0	4,0	2,8	0,8	
	LDMX 100420 SR-MP	BCP25M	5103996	●	10	7,0	4,0	2,8	2	
LDMX 100420 SR-MP	BCP35M	5103994	●	10	7,0	4,0	2,8	2		
LDMX 100430 SR-MP	BCP25M	5104003	●	10	7,0	4,0	2,8	3		
LDMX 100430 SR-MP	BCP35M	5103998	●	10	7,0	4,0	2,8	3		

Bestellbeispiel Order example: 10 Stück pieces 5117602 oder or CDGX 060210 SR-FH BCH03M

Schnittwertempfehlungen Fräser 45° siehe Seite 76

Cutting data recommendations milling cutter 45°, see page 76

Schnittwertempfehlungen Fräser 90° siehe Seite 130





Cutting data recommendations milling cutter 90°, see page 130

Schnittwertempfehlungen 3D Fräsen siehe Seite 174

Cutting data recommendations 3D milling, see page 174

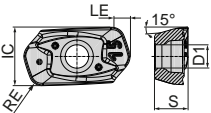
Farbliche Abbildung der WSP müssen nicht dem Original entsprechen!

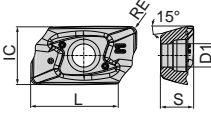
Colours of the original indexable inserts may deviate from the illustration!

CEDC = Anzahl der Schneidkanten CEDC = Number of cutting edges	Artikelbezeichnung Item code	Schneidstoffsorte Cutting materials	Bestell-Nr. Ordering No.	Verfügbarkeit Availability	Abmessungen [mm] Dimensions [mm]						Werkzeuge Tools
					L	LE	IC	S	D1	RE	
  CEDC = 2	HFC Platten/HFC insert										
	LDMX 100415 SR-MPH	BCP20M	5092202	●	-	1,5	7,0	4,0	2,8	1,5	Werkzeuge Tools BETAtec 90P Feed Seite, see page 90
	LDMX 100415 SR-MPH	BCP25M	5081952	●	-	1,5	7,0	4,0	2,8	1,5	
	LDMX 100415 SR-MPH	BCP30M	5092201	●	-	1,5	7,0	4,0	2,8	1,5	
	LDMX 100415 SR-MPH	BCP35M	5081951	●	-	1,5	7,0	4,0	2,8	1,5	
	LDMX 100415 SR-MMH	BCM35M	5092304	●	-	1,5	7,0	4,0	2,8	1,5	
	LDMX 100415 SR-MMH	BCM40M	5081954	●	-	1,5	7,0	4,0	2,8	1,5	
	LDMX 100415 SR-MKH	BCK15M	5092210	●	-	1,5	7,0	4,0	2,8	1,5	
	LDMX 100415 SR-MKH	BCK20M	5092208	●	-	1,5	7,0	4,0	2,8	1,5	
	LDMX 100415 SR-MHH	BCH05M	5145436	○	-	1,5	7,0	4,0	2,8	1,5	
LDMX 100415 SR-MHH	BCH10M	5145445	●	-	1,5	7,0	4,0	2,8	1,5		
  CEDC = 2	90° Platten/90° inserts										
	LDMX 180508 SR-MP	BCP25M	5104006	●	18	-	9,65	5	4,15	0,8	Werkzeuge Tools BETAtec 90P Feed Seite, see page 90
	LDMX 180508 SR-MP	BCP35M	5104004	●	18	-	9,65	5	4,15	0,8	
	LDMX 180508 SR-MP	BCP40M	5104078	●	18	-	9,65	5	4,15	0,8	
	LDMX 180508 SR-MM	BCM35M	5104007	●	18	-	9,65	5	4,15	0,8	
	LDMX 180508 SR-MM	BCM40M	5104012	●	18	-	9,65	5	4,15	0,8	
	LDMX 180508 SR-MK	BCK20M	5104008	●	18	-	9,65	5	4,15	0,8	
	LDMX 180508 SR-MK	BCK20M	5104008	●	18	-	9,65	5	4,15	0,8	
	LDGX 180508 FR-MN	BCN10M	5104010	●	18	-	9,65	5	4,15	0,8	
	LDGX 180508 FR-MN	BWN10M	5104009	●	18	-	9,65	5	4,15	0,8	
	LDMX 180512 SR-RP	BCP25M	5107507	●	18	-	9,65	5	4,15	1,2	
	LDMX 180512 SR-RP	BCP35M	5107508	●	18	-	9,65	5	4,15	1,2	
	LDMX 180512 SR-RP	BCP40M	5107510	●	18	-	9,65	5	4,15	1,2	
	LDMX 180512 SR-MM	BCM35M	5145425	●	18	-	9,65	5	4,15	1,2	
	LDMX 180512 SR-MM	BCM40M	5145427	●	18	-	9,65	5	4,15	1,2	
	LDMX 180512 SR-RK	BCK20M	5107511	●	18	-	9,65	5	4,15	1,2	
	LDMX 180516 SR-RP	BCP25M	5151254	●	18	-	9,65	5	4,15	1,6	
LDMX 180516 SR-RP	BCP35M	5151255	●	18	-	9,65	5	4,15	1,6		
LDMX 180516 SR-MM	BCM35M	5151154	●	18	-	9,65	5	4,15	1,6		
LDMX 180516 SR-MM	BCM40M	5151157	●	18	-	9,65	5	4,15	1,6		

Bestellbeispiel Order example: 10 Stück pieces 5092202 oder or LDMX 100415 SR-MPH BCP20M

Schnittwertempfehlungen Fräser 90° siehe Seite 130

Cutting data recommendations milling cutter 90°, see page 130

Sortenübersicht Seite 6

Grade overview, see page 6

- Verfügbar ab Lager Available from stock
- Lieferzeit auf Anfrage Delivery time on request

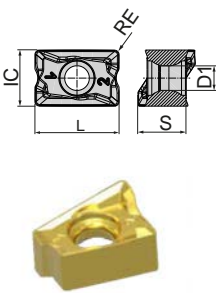
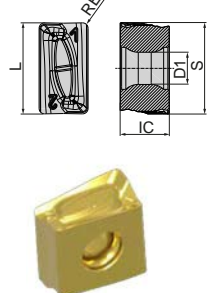
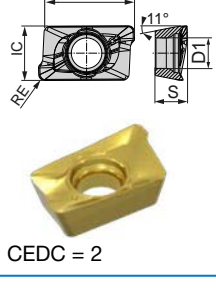
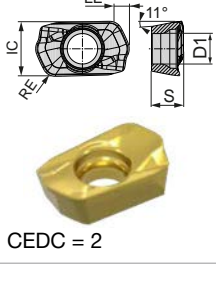
CEDC = Anzahl der Schneidkanten CEDC = Number of cutting edges	Artikelbezeichnung Item code	Schneidstoffsorte Cutting materials	Bestell-Nr. Ordering No.	Verfügbarkeit Availability	Abmessungen [mm] Dimensions [mm]						Werkzeuge Tools
					L	LE	IC	S	D1	RE	
 <p>CEDC = 4</p>	LNMX 100605 SR-RP	BCP25M	5085137	●	10	-	6,5	4,85	3,5	0,5	DELTAtec 90N Seite, see page 116
	LNMX 100605 SR-RP	BCP35M	5081015	●	10	-	6,5	4,85	3,5	0,5	
	LNMX 100605 SR-RP	BCP40M	5081956	●	10	-	6,5	4,85	3,5	0,5	
	LNMX 100605 SR-RM	BCM40M	5105547	●	10	-	6,5	4,85	3,5	0,5	
	LNMX 100605 SR-RK	BCK15M	5092063	●	10	-	6,5	4,85	3,5	0,5	
	LNMX 100605 SR-RK	BCK20M	5081881	●	10	-	6,5	4,85	3,5	0,5	
	LNMX 151008 SR-RP	BCP25M	5085138	●	15	-	10,0	8,61	4,4	0,8	
	LNMX 151008 SR-RP	BCP35M	5081016	●	15	-	10,0	8,61	4,4	0,8	
	LNMX 151008 SR-RP	BCP40M	5081957	●	15	-	10,0	8,61	4,4	0,8	
	LNMX 151008 SR-RM	BCM40M	5105540	●	15	-	10,0	8,61	4,4	0,8	
	LNMX 151008 SR-RK	BCK15M	5092102	●	15	-	10,0	8,61	4,4	0,8	
	LNMX 151008 SR-RK	BCK20M	5081017	●	15	-	10,0	8,61	4,4	0,8	
 <p>CEDC = 4</p>	LNMX 090708 SR-MP	BCP25M	5192091	●	9,0	-	5,0	6,49	2,4	0,8	DELTAtec 90N Tang Seite, see page 120
	LNMX 090708 SR-MP	BCP35M	5192093	●	9,0	-	5,0	6,49	2,4	0,8	
	LNMX 090708 SR-MM	BCM40M	5192095	○	9,0	-	5,0	6,49	2,4	0,8	
	LNMX 090708 SR-MK	BCK20M	5192094	●	9,0	-	5,0	6,49	2,4	0,8	
	LNMX 131308 SR-MP	BCP25M	5092053	●	13	-	7	12,7	4,6	0,8	
	LNMX 131308 SR-MP	BCP35M	5092051	●	13	-	7	12,7	4,6	0,8	
	LNMX 131308 SR-MM	BCM40M	5105549	●	13	-	7	12,7	4,6	0,8	
	LNMX 131308 SR-RP	BCP30M	5092037	●	13	-	7	12,7	4,6	0,8	
	LNMX 131308 SR-RP	BCP35M	5081018	●	13	-	7	12,7	4,6	0,8	
	LNMX 131308 SR-RP	BCP40M	5081019	○	13	-	7	12,7	4,6	0,8	
	LNMX 131308 SR-RK	BCK15M	5092038	●	13	-	7	12,7	4,6	0,8	
	LNMX 131308 SR-RK	BCK20M	5081867	●	13	-	7	12,7	4,6	0,8	
 <p>CEDC = 2</p>	90° Platten/90° inserts										BET Atec 90P Feed Seite, see page 90
	LPMX 060204-MP	BCP25M	5149998	●	6	-	3,64	2,15	2,05	0,4	
	LPMX 060204-MP	BCP35M	5150000	●	6	-	3,64	2,15	2,05	0,4	
	LPMX 060204-MM	BCM35M	5150001	●	6	-	3,64	2,15	2,05	0,4	
	LPMX 060220-MH	BCH10M	5168674	●	6	-	3,64	2,15	2,05	2,0	
	LPMX 060220-MH	BCH30M	5168675	●	6	-	3,64	2,15	2,05	2,0	
 <p>CEDC = 2</p>	HFC Platten/HFC insert										BET Atec 90P Feed Seite, see page 90
	LPMX 060210-MPH	BCP20M	5150004	●	-	0,7	3,64	2,15	2,05	1	
	LPMX 060210-MPH	BCP25M	5150006	●	-	0,7	3,64	2,15	2,05	1	
	LPMX 060210-MMH	BCM35M	5150007	●	-	0,7	3,64	2,15	2,05	1	
	LPMX 060210-MHH	BCH05M	5150009	○	-	0,7	3,64	2,15	2,05	1	
	LPMX 060210-MHH	BCH10M	5150010	●	-	0,7	3,64	2,15	2,05	1	
LPMX 060210 MMH	BCS35M	5212100	●	-	0,7	3,64	2,15	2,05	1		

Bestellbeispiel Order example: 10 Stück pieces 5085137 oder or LNMX 100605 SR-RP BCP25M

Schnittwertempfehlungen Fräser 90° siehe Seite 130

Cutting data recommendations milling cutter 90°, see page 130

Farbliche Abbildung der WSP müssen nicht dem Original entsprechen!

Colours of the original indexable inserts may deviate from the illustration!

CEDC = Anzahl der Schneidkanten CEDC = Number of cutting edges	Artikelbezeichnung Item code	Schneidstoffsorte Cutting materials	Bestell-Nr. Ordering No.	Verfügbarkeit Availability	Abmessungen [mm] Dimensions [mm]					Werkzeuge Tools
					L	IC	S	D1	RE	
<p>CEDC = 8</p>	ODMT 060508 SN-MP	BCP20M	5142953	○	6,5	15,88	5,56	5,5	0,8	
	ODMT 060508 SN-MP	BCP25M	5142954	●	6,5	15,88	5,56	5,5	0,8	
	ODMT 060508 SN-MP	BCP30M	5142956	○	6,5	15,88	5,56	5,5	0,8	
	ODMT 060508 SN-MP	BCP35M	5142957	●	6,5	15,88	5,56	5,5	0,8	
	ODMT 060508 SN-MM	BCM35M	5142958	●	6,5	15,88	5,56	5,5	0,8	
	ODMT 060508 SN-MM	BCM40M	5142959	●	6,5	15,88	5,56	5,5	0,8	
	ODMT 060508 SN-MH	BCH05M	5142965	○	6,5	15,88	5,56	5,5	0,8	
	ODMT 060508 SN-MH	BCH10M	5142966	●	6,5	15,88	5,56	5,5	0,8	
<p>CEDC = 8</p>	ODMW 060508 SN-RP	BCP30M	5142969	○	6,5	15,88	5,56	5,5	0,8	
	ODMW 060508 SN-RP	BCP35M	5142970	○	6,5	15,88	5,56	5,5	0,8	
	ODMW 060508 SN-RP	BCP40M	5142971	●	6,5	15,88	5,56	5,5	0,8	
	ODMW 060508 SN-RK	BCK15M	5142975	○	6,5	15,88	5,56	5,5	0,8	
	ODMW 060508 SN-RK	BCK20M	5142981	●	6,5	15,88	5,56	5,5	0,8	
<p>CEDC = 8</p>	OFER 070405 SN-BP	BCP25M	5081944	●	7	17,83	4,76	-	0,5	
<p>CEDC = 8</p>	OFEX 05T305 SN-BP	BCP25M	5080876	●	5	12,7	3,97	4,6	0,5	
	OFEX 05T305 SN-BP	BCP30M	5080878	●	5	12,7	3,97	4,6	0,5	
	OFEX 05T305 SN-BP	BCP35M	5079387	●	5	12,7	3,97	4,6	0,5	
<p>CEDC = 8</p>	ONMQ 0506-FW	BCH10M	5125076	●	5	12,7	5,8	5,45	0,8	
	ONMQ 0806-FW	BCM35M	5092307	●	8	19,1	6,95	6,75	0,8	
	ONMQ 0806-FW	BCH10M	5125074	●	8	19,1	6,95	6,75	0,8	

Pitec 45N
Seite, see page 65

Bestellbeispiel Order example: 10 Stück pieces 5142953 oder or ODMT 060508 SN-MP BCP20M
Schnittwertempfehlungen Fräser 45° siehe Seite 76
Cutting data recommendations milling cutter 45°, see page 76
Sortenübersicht Seite 6
Grade overview, see page 6

● Verfügbar ab Lager Available from stock
○ Lieferzeit auf Anfrage
Delivery time on request

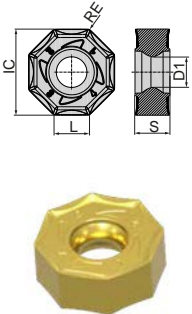
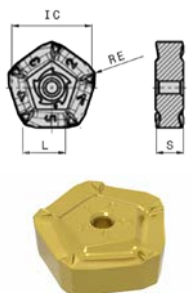
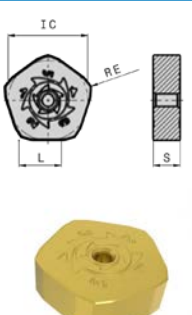
CEDC = Anzahl der Schneidkanten CEDC = Number of cutting edges	Artikelbezeichnung Item code	Schneidstoffsorte Cutting materials	Bestell-Nr. Ordering No.	Verfügbarkeit Availability	Abmessungen [mm] Dimensions [mm]					Werkzeuge Tools
					L	IC	S	D1	RE	
 <p>CEDC = 16</p>	ONMU 050608 SN-MP	BCP25M	5124904	●	5	12,7	5,8	5,45	0,8	Plitec 45N Seite, see page 32
	ONMU 050608 SN-MP	BCP35M	5124905	●	5	12,7	5,8	5,45	0,8	
	ONMU 050608 SN-MM	BCM35M	5124906	●	5	12,7	5,8	5,45	0,8	
	ONMU 050608 SN-MM	BCM40M	5124907	●	5	12,7	5,8	5,45	0,8	
	ONMU 050608 SN-MK	BCK15M	5146195	●	5	12,7	5,8	5,45	0,8	
	ONMU 050608 SN-MK	BCK20M	5124909	●	5	12,7	5,8	5,45	0,8	
	ONMU 050608 SN-MH	BCH05M	5146193	●	5	12,7	5,8	5,45	0,8	
	ONMU 050608 SN-MH	BCH10M	5124908	●	5	12,7	5,8	5,45	0,8	
	ONMU 080608 SN-MP	BCP20M	5092103	●	8	19,1	6,95	6,75	0,8	
	ONMU 080608 SN-MP	BCP25M	5081895	●	8	19,1	6,95	6,75	0,8	
	ONMU 080608 SN-MP	BCP30M	5081885	●	8	19,1	6,95	6,75	0,8	
	ONMU 080608 SN-MP	BCP35M	5081888	●	8	19,1	6,95	6,75	0,8	
	ONMU 080608 SN-MM	BCM35M	5081958	●	8	19,1	6,95	6,75	0,8	
	ONMU 080608 SN-MM	BCM40M	5081896	●	8	19,1	6,95	6,75	0,8	
	ONMU 080608 SN-MK	BCK15M	5081894	●	8	19,1	6,95	6,75	0,8	
	ONMU 080608 SN-MK	BCK20M	5081890	●	8	19,1	6,95	6,75	0,8	
ONMU 080608 SN-MM	BCS35M	5196924	●	8	19,1	6,95	6,75	0,8		
 <p>CEDC = 10</p>	PNMF 1307 ZNSR-MP	BCP35M	5220291	●	13	23,4	7,94	-	1	KAPPAtec 55N Seite, see page 32
	PNMF 1307 ZNSR-MP	BCP40M	5220294	●	13	23,4	7,94	-	1	
	PNMF 1307 ZNSR-RM	BCM40M	5220295	●	13	23,4	7,94	-	1	
 <p>CEDC = 10</p>	PNMM 1307 ZNSN-MK	BCK15M	5220297	●	13	23,4	7,94	-	1	KAPPAtec 55N Seite, see page 32
	PNMM 1307 ZNSN-MK	BCK20M	5220298	●	13	23,4	7,94	-	1	





Bestellbeispiel Order example: 10 Stück pieces 5124904 oder or ONMU 050608 SN-MP BCP25M

Schnittwertempfehlungen Fräser 45° siehe Seite 76

Cutting data recommendations milling cutter 45°, see page 76

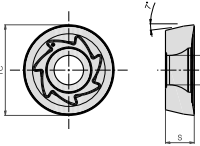
Farbliche Abbildung der WSP müssen nicht dem Original entsprechen!

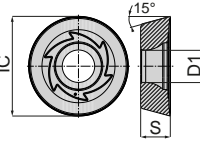
Colours of the original indexable inserts may deviate from the illustration!

CEDC = Anzahl der Schneidkanten CEDC = Number of cutting edges	Artikelbezeichnung Item code	Schneidstoffsorte Cutting materials	Bestell-Nr. Ordering No.	Verfügbarkeit Availability	Abmessungen [mm] Dimensions [mm]					Werkzeuge Tools
					L	IC	S	D1	RE	
  <p>CEDC = 8</p>	RCMX 2006 MO-RP	BCP30M	5169798	○	-	20	6,35	6,5	-	ISO 00P Seite, see page 154
	RCMX 2006 MO-RP	BCP35M	5151563	●	-	20	6,35	6,5	-	
	RCMX 2006 MO-RP	BCP40M	5151565	●	-	20	6,35	6,5	-	
 	RDKT 12T3 MOS-MP	BCP20M	5117644	●	-	12	3,97	3,9	-	
	RDKT 12T3 MOS-MP	BCP25M	5117645	●	-	12	3,97	3,9	-	
	RDKT 12T3 MOS-MP	BCP30M	5117648	●	-	12	3,97	3,9	-	
	RDKT 12T3 MOS-MP	BCP35M	5117646	●	-	12	3,97	3,9	-	
	RDHT 12T3 MO-MM	BCM35M	5107513	●	-	12	3,97	3,9	-	
	RDHT 12T3 MO-MM	BCM40M	5107512	●	-	12	3,97	3,9	-	
	RDKT 12T3 MOS-MM	BCM35M	5117650	●	-	12	3,97	3,9	-	
	RDKT 12T3 MOS-MM	BCM40M	5117651	●	-	12	3,97	3,9	-	
	RDHT 12T3 MO-MS	BCS35M	5171190	○	-	12	3,97	3,9	-	
	RDKT 1604 MOS-MP	BCP20M	5117666	○	-	16	4,76	5,2	-	
	RDKT 1604 MOS-MP	BCP25M	5117667	●	-	16	4,76	5,2	-	
	RDKT 1604 MOS-MP	BCP30M	5117668	●	-	16	4,76	5,2	-	
	RDKT 1604 MOS-MP	BCP35M	5117669	●	-	16	4,76	5,2	-	
	RDKT 1604 MOS-MM	BCM35M	5117670	●	-	16	4,76	5,2	-	
RDKT 1604 MOS-MM	BCM40M	5117671	●	-	16	4,76	5,2	-		
RDHT 1604 MO-MS	BCS35M	5162343	●	-	16	4,76	5,2	-		

Bestellbeispiel Order example: 10 Stück pieces 5169798 oder or RCMX 20206 MO-RP BCP30M
 Schnittwertempfehlungen 3D Fräsen siehe Seite 174
 Cutting data recommendations 3D milling, see page 174
 Sortenübersicht Seite 6
 Grade overview, see page 6

- Verfügbar ab Lager Available from stock
- Lieferzeit auf Anfrage Delivery time on request

CEDC = Anzahl der Schneidkanten CEDC = Number of cutting edges	Artikelbezeichnung Item code	Schneidstoffsorte Cutting materials	Bestell-Nr. Ordering No.	Verfügbarkeit Availability	Abmessungen [mm] Dimensions [mm]			Werkzeuge Tools
					IC	S	D1	
	RDKW 0501 MOS-MP	BCP20M	5117486	●	5	1,5	2,2	ISO 00P Seite, see page 154
	RDKW 0501 MOS-MP	BCP25M	5117495	●	5	1,5	2,2	
	RDKW 0501 MOS-MM	BCM35M	5117482	●	5	1,5	2,2	
	RDKW 0501 MOS-MM	BCM40M	5117483	●	5	1,5	2,2	
	RDKW 0501 MOS-MK	BCK15M	5117479	●	5	1,5	2,2	
	RDKW 0501 MOS-MK	BCK20M	5117481	●	5	1,5	2,2	
	RDKW 0501 MOS-FH	BCH03M	5117408	●	5	1,5	2,2	
	RDKW 0501 MOS-MH	BCH05M	5117414	●	5	1,5	2,2	
	RDKW 0501 MOS-MH	BCH10M	5117477	●	5	1,5	2,2	
	RDKW 0501 MOS-RH	BCH30M	5117537	●	5	1,5	2,2	
	RDKW 0702 MOS-MP	BCP20M	5117535	○	7	2,38	2,7	
	RDKW 0702 MOS-MP	BCP25M	5117529	●	7	2,38	2,7	
	RDKW 0702 MOS-MP	BCP30M	5117509	●	7	2,38	2,7	
	RDKW 0702 MOS-MP	BCP35M	5117510	●	7	2,38	2,7	
	RDKW 0702 MOS-MM	BCM35M	5117538	●	7	2,38	2,7	
	RDKW 0702 MOS-MM	BCM40M	5117539	●	7	2,38	2,7	
	RDKW 0702 MOS-MK	BCK15M	5117504	●	7	2,38	2,7	
	RDKW 0702 MOS-MK	BCK20M	5117507	●	7	2,38	2,7	
	RDHW 0702 MOS-MH	BCH05M	5147192	●	7	2,38	2,7	
	RDHW 0702 MOS-MH	BCH10M	5147195	●	7	2,38	2,7	
RDHW 0702 MOS-RH	BCH30M	5147198	●	7	2,38	2,7		
RDKW 0702 MOS-MH	BCH05M	5117501	●	7	2,38	2,7		
RDKW 0702 MOS-MH	BCH10M	5117503	●	7	2,38	2,7		
RDKW 0702 MOS-RH	BCH30M	5117622	●	7	2,38	2,7		
	RDKW 1003 MOS-MP	BCP20M	5086933	●	10	3,18	3,9	
	RDKW 1003 MOS-MP	BCP25M	5086932	●	10	3,18	3,9	
	RDKW 1003 MOS-MP	BCP30M	5086935	●	10	3,18	3,9	
	RDKW 1003 MOS-MP	BCP35M	5086934	●	10	3,18	3,9	
	RDKW 1003 MOS-MM	BCM35M	5117626	●	10	3,18	3,9	
	RDKW 1003 MOS-MM	BCM40M	5117628	●	10	3,18	3,9	
	RDKW 1003 MOS-MK	BCK15M	5086814	●	10	3,18	3,9	
	RDKW 1003 MOS-MK	BCK20M	5079553	●	10	3,18	3,9	
	RDHW 1003 MOS-FH	BCH03M	5147540	○	10	3,18	3,9	
	RDHW 1003 MOS-MH	BCH05M	5147200	○	10	3,18	3,9	
	RDHW 1003 MOS-MH	BCH10M	5147201	○	10	3,18	3,9	
	RDHW 1003 MOS-RH	BCH30M	5147202	●	10	3,18	3,9	
	RDKW 1003 MOS-MH	BCH05M	5117541	●	10	3,18	3,9	
	RDKW 1003 MOS-MH	BCH10M	5117542	●	10	3,18	3,9	
	RDKW 1003 MOS-RH	BCH30M	5117630	●	10	3,18	3,9	
	RDKW 12T3 MOS-MP	BCP20M	5086939	●	12	3,97	3,9	
	RDKW 12T3 MOS-MP	BCP25M	5086938	●	12	3,97	3,9	
	RDKW 12T3 MOS-MP	BCP30M	5087036	●	12	3,97	3,9	
	RDKW 12T3 MOS-MP	BCP35M	5086940	●	12	3,97	3,9	
	RDKW 12T3 MOS-MK	BCK15M	5086937	○	12	3,97	3,9	
RDKW 12T3 MOS-MK	BCK20M	5079554	●	12	3,97	3,9		
RDHW 12T3 MOS-FH	BCH03M	5147203	●	12	3,97	3,9		
RDHW 12T3 MOS-MH	BCH05M	5147204	●	12	3,97	3,9		
RDHW 12T3 MOS-MH	BCH10M	5147205	○	12	3,97	3,9		
RDHW 12T3 MOS-RH	BCH30M	5147207	○	12	3,97	3,9		
RDKW 12T3 MOS-MH	BCH05M	5117633	●	12	3,97	3,9		
RDKW 12T3 MOS-MH	BCH10M	5117636	●	12	3,97	3,9		
RDKW 12T3 MOS-RH	BCH30M	5117641	●	12	3,97	3,9		

Bestellbeispiel Order example: 10 Stück pieces 5117486 oder or RDKW 0501 MOS-MP BCP20M
Schnittwertempfehlungen 3D Fräsen siehe Seite 174
Cutting data recommendations 3D milling, see page 174

Sortenübersicht Seite 6
Grade overview, see page 6

CEDC = Anzahl der Schneidkanten CEDC = Number of cutting edges	Artikelbezeichnung Item code	Schneidstoffsorte Cutting materials	Bestell-Nr. Ordering No.	Verfügbarkeit Availability	Abmessungen [mm] Dimensions [mm]			Werkzeuge Tools
					IC	S	D1	
 CEDC = 8	RDKW 1604 MOS-MP	BCP20M	5087042	●	16	4,76	5,2	ISO 00P Seite, see page 154
	RDKW 1604 MOS-MP	BCP25M	5087040	●	16	4,76	5,2	
	RDKW 1604 MOS-MP	BCP30M	5087050	●	16	4,76	5,2	
	RDKW 1604 MOS-MP	BCP35M	5087044	●	16	4,76	5,2	
	RDKW 1604 MOS-MK	BCK15M	5087039	●	16	4,76	5,2	
	RDKW 1604 MOS-MK	BCK20M	5079555	●	16	4,76	5,2	
	RDHW 1604 MOS-MH	BCH05M	5147209	●	16	4,76	5,2	
	RDHW 1604 MOS-MH	BCH10M	5147210	●	16	4,76	5,2	
	RDHW 1604 MOS-RH	BCH30M	5147211	●	16	4,76	5,2	
	RDKW 1604 MOS-MH	BCH05M	5117662	●	16	4,76	5,2	
	RDKW 1604 MOS-MH	BCH10M	5117663	●	16	4,76	5,2	
	RDKW 1604 MOS-RH	BCH30M	5117665	●	16	4,76	5,2	
 CEDC = 8	RPMX 0802M0-MS	BCS35M	5169157	●	8	2,38	2,8	VARIOtec 00P Seite, see page 169
	RPMX 0802M0-MS	BCS40M	5169158	●	8	2,38	2,8	
 CEDC = 8	RPMX 10T3M0-MS	BCS35M	5155839	●	10	3,97	3,9	
	RPMX 10T3M0-MS	BCS40M	5167407	●	10	3,97	3,9	
 CEDC = 6	RPMX 1204M0-MS	BCS35M	5154658	●	12	4,76	3,9	
	RPMX 1204M0-MS	BCS40M	5167406	●	12	4,76	3,9	

Bestellbeispiel Order example: 10 Stück pieces 5087042 oder or RDKW 1604 MOS-MP BCP20M
 Schnittwertempfehlungen Fräser 45° siehe Seite 76.
 Cutting data recommendations milling cutter 45°.
 Schnittwertempfehlungen 3D Fräsen siehe Seite 174
 Cutting data recommendations 3D milling, see page 174
 Farbliche Abbildung der WSP müssen nicht dem Original entsprechen!
 Colours of the original indexable inserts may deviate from the illustration!

● Verfügbar ab Lager Available from stock
 ○ Lieferzeit auf Anfrage Delivery time on request

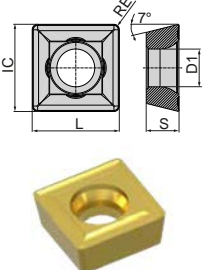
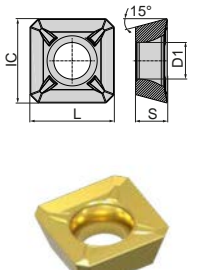
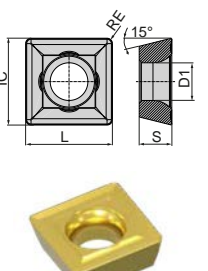
CEDC = Anzahl der Schneidkanten CEDC = Number of cutting edges	Artikelbezeichnung Item code	Schneidstoffsorte Cutting materials	Bestell-Nr. Ordering No.	Verfügbarkeit Availability	Abmessungen [mm] Dimensions [mm]					Werkzeuge Tools	
					L	IC	S	D1	RE		
 <p>CEDC = 4</p>	SCMX 120512	BCP30M	5080883	○	12,70	12,70	4,95	5,5	1,2		
 <p>CEDC = 4</p>	SDHT 1204 AESN	BCP25M	5080886	●	12,70	12,70	4,76	5,5	-		
	SDHT 1204 AESN	BCP30M	5080888	○	12,70	12,70	4,76	5,5	-		
	SDHT 1204 AESN	BCP35M	5080889	●	12,70	12,70	4,76	5,5	-		
	SDHT 1204 AESN-BM	BCM40M	5080890	●	12,70	12,70	4,76	5,5	-		
	SDHT 1204 AESN	BCK15M	5081946	●	12,70	12,70	4,76	5,5	-		
	SDHT 1204 AEFN-ALC	BCN10M	5080884	●	12,70	12,70	4,76	5,5	-		
	SDHT 1204 AEFN-ALC	BWN10M	5080885	●	12,70	12,70	4,76	5,5	-		
	SDHT 1504 AESN	BCP30M	5080892	●	15,88	15,88	4,76	5,5	-		
	SDHT 1504 AEFN-ALC	BWN10M	5080891	●	15,88	15,88	4,76	5,5	-		
 <p>CEDC = 4</p>	SDMT 090308	BCP25M	5080893	●	9,52	9,52	3,18	4	0,8		
	SDMT 120408-SN	BCP30M	5080895	●	12,70	12,70	4,76	5,5	0,8		
	SDMT 1205 PDSR-BP	BCP30M	5080897	●	12,70	12,70	5,0	4,95	0,8		
	SDMT 1205 PDSR-BP	BCP35M	5080899	●	12,70	12,70	5,0	4,95	0,8		
	SDMT 1205 PDSR-BP	BCK20M	5168337	○	12,70	12,70	5,0	4,95	0,8		

Bestellbeispiel Order example: 10 Stück pieces 5080883 oder or SCMX 120512 BCP30M

Sortenübersicht Seite 6

Grade overview, see page 6

CEDC = Anzahl der Schneidkanten CEDC = Number of cutting edges	Artikelbezeichnung Item code	Schneidstoffsorte Cutting materials	Bestell-Nr. Ordering No.	Verfügbarkeit Availability	Abmessungen [mm] Dimensions [mm]						Werkzeuge Tools
					L	LE	IC	S	D1	RE	
 CEDC = 4	HFC Platten/HFC insert										
	SDMT 060212-MPH	BCP25M	5125079	●	-	1,0	6,75	2,5	2,5	1,2	
	SDMT 060212-MMH	BCM35M	5125081	●	-	1,0	6,75	2,5	2,5	1,2	
	SDMT 060212-MSH	BCS35M	5171191	●	-	1,0	6,75	2,5	2,5	1,2	
	SDMT 060212-MHH	BCH10M	5125083	●	-	1,0	6,75	2,5	2,5	1,2	
	SDMT 060212-MHH	BCH30M	5156757	●	-	1,0	6,75	2,5	2,5	1,2	
 CEDC = 4	90° Platten/90° inserts										
	SDHT 100404 FR-MN	BCN10M	5141469	●	10,4	-	10,4	4,86	3,5	0,4	
	SDHT 100404 FR-MN	BWN10M	5141468	●	10,4	-	10,4	4,86	3,5	0,4	
	SDMT 100408 SR-MP	BCP25M	5092104	●	10,4	-	10,4	4,86	3,5	0,8	
	SDMT 100408 SR-MP	BCP35M	5081909	●	10,4	-	10,4	4,86	3,5	0,8	
	SDMT 100408 SR-MP	BCP40M	5092108	●	10,4	-	10,4	4,86	3,5	0,8	
	SDMT 100408 ER-MM	BCM35M	5092224	●	10,4	-	10,4	4,86	3,5	0,8	
	SDMT 100408 ER-MM	BCM40M	5081917	●	10,4	-	10,4	4,86	3,5	0,8	
	SDMT 100415 ER-MM	BCM35M	5121936	●	10,4	-	10,4	4,86	3,5	1,5	
	SDMT 100408 SR-MK	BCK20M	5081910	●	10,4	-	10,4	4,86	3,5	0,8	
	SDHT 100408 FR-MN	BCN10M	5141467	●	10,4	-	10,4	4,86	3,5	0,8	
	SDHT 100408 FR-MN	BWN10M	5141466	●	10,4	-	10,4	4,86	3,5	0,8	
 CEDC = 4	HFC Platten/HFC inserts										
	SDMT 100415 SR-MPH	BCP20M	5087590	●	-	1,1	10,2	4,76	3,5	1,5	
	SDMT 100415 SR-MPH	BCP25M	5081918	●	-	1,1	10,2	4,76	3,5	1,5	
	SDMT 100415 SR-MPH	BCP30M	5092114	●	-	1,1	10,2	4,76	3,5	1,5	
	SDMT 100415 SR-MPH	BCP35M	5092113	●	-	1,1	10,2	4,76	3,5	1,5	
	SDMT 100415 ER-MMH	BCM35M	5092231	●	-	1,1	10,2	4,76	3,5	1,5	
	SDMT 100415 ER-MMH	BCM40M	5081922	●	-	1,1	10,2	4,76	3,5	1,5	
	SDGT 100415 SR-MTH	BCS35M	5125072	●	-	1,1	10,2	4,76	3,5	1,5	
	SDMT 100415 SR-MSH	BCS35M	5158371	●	-	1,1	10,2	4,76	3,5	1,5	
	SDMT 100415 SR-MSH	BCS40M	5168096	●	-	1,1	10,2	4,76	3,5	1,5	
	SDMT 100415 SR-MHH	BCH10M	5117559	●	-	1,1	10,2	4,76	3,5	1,5	
	SDMT 100415 SR-MHH	BCH30M	5145418	●	-	1,1	10,2	4,76	3,5	1,5	
	HFC Platten/HFC inserts										
	SDMW 100415 SR-RPH	BCP20M	5092120	●	-	1,1	10,2	4,76	3,5	1,5	
	SDMW 100415 SR-RPH	BCP25M	5092116	●	-	1,1	10,2	4,76	3,5	1,5	
	SDMW 100415 SR-RPH	BCP30M	5087591	●	-	1,1	10,2	4,76	3,5	1,5	
	SDMW 100415 SR-RPH	BCP35M	5081919	●	-	1,1	10,2	4,76	3,5	1,5	
	SDMW 100415 SR-RKH	BCK15M	5087592	●	-	1,1	10,2	4,76	3,5	1,5	
	SDMW 100415 SR-RKH	BCK20M	5081920	●	-	1,1	10,2	4,76	3,5	1,5	
	SDMW 100415 SR-RHH	BCH05M	5117552	●	-	1,1	10,2	4,76	3,5	1,5	
	SDMW 100415 SR-RHH	BCH10M	5117553	●	-	1,1	10,2	4,76	3,5	1,5	
	SDMW 100415 SR-RHH	BCH30M	5117557	●	-	1,1	10,2	4,76	3,5	1,5	

DELTAtec 90P Feed
Seite, see page 103

Bestellbeispiel Order example: 10 Stück pieces 5125079 oder or SDMT 060212-MPH BCP25M

Schnittwertempfehlungen siehe Fräsen 90° Seite 130

Cutting data recommendations milling cutter 90°, see page 130

Farbliche Abbildung der WSP müssen nicht dem Original entsprechen!

Colours of the original indexable inserts may deviate from the illustration!

● Verfügbar ab Lager Available from stock

○ Lieferzeit auf Anfrage

Delivery time on request

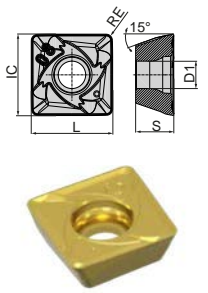
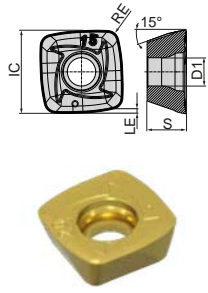
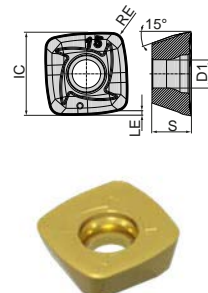
CEDC = Anzahl der Schneidkanten CEDC = Number of cutting edges	Artikelbezeichnung Item code	Schneidstoffsorte Cutting materials	Bestell-Nr. Ordering No.	Verfügbarkeit Availability	Abmessungen [mm] Dimensions [mm]						Werkzeuge Tools
					L	LE	IC	S	D1	RE	
 CEDC = 4	90° Platten/90° inserts										
	SDHT 140508 FR-MN	BCN10M	5141465	○	14,8	-	14,8	5,2	5,5	0,8	DELTAtec 90P Feed Seite, see page 103
	SDHT 140508 FR-MN	BWN10M	5141463	●	14,8	-	14,8	5,2	5,5	0,8	
	SDMT 140512 SR-MP	BCP25M	5092127	●	14,8	-	14,8	5,2	5,5	1,2	
	SDMT 140512 SR-MP	BCP35M	5081923	●	14,8	-	14,8	5,2	5,5	1,2	
	SDMT 140512 SR-MP	BCP40M	5092129	●	14,8	-	14,8	5,2	5,5	1,2	
	SDMT 140512 ER-MM	BCM35M	5092266	●	14,8	-	14,8	5,2	5,5	1,2	
	SDMT 140512 ER-MM	BCM40M	5081925	●	14,8	-	14,8	5,2	5,5	1,2	
	SDMT 140512 SR-MK	BCK20M	5081924	●	14,8	-	14,8	5,2	5,5	1,2	
	SDHT 140512 FR-MN	BCN10M	5141464	○	14,8	-	14,8	5,2	5,5	1,2	
	SDHT 140512 FR-MN	BWN10M	5141462	●	14,8	-	14,8	5,2	5,5	1,2	
	 CEDC = 4	HFC Platten/HFC inserts									
SDMT 140520 SR-MPH		BCP20M	5087593	●	-	2,2	14,7	5	5,5	2	
SDMT 140520 SR-MPH		BCP25M	5081926	●	-	2,2	14,7	5	5,5	2	
SDMT 140520 SR-MPH		BCP30M	5092131	●	-	2,2	14,7	5	5,5	2	
SDMT 140520 SR-MPH		BCP35M	5092130	●	-	2,2	14,7	5	5,5	2	
SDMT 140520 ER-MMH		BCM35M	5092290	●	-	2,2	14,7	5	5,5	2	
SDMT 140520 ER-MMH		BCM40M	5081929	●	-	2,2	14,7	5	5,5	2	
SDMT 140520 SR-MSH		BCS35M	5158373	●	-	2,2	14,7	5	5,5	2	
SDMT 140520 SR-MSH		BCS40M	5168098	●	-	2,2	14,7	5	5,5	2	
SDMT 140520 SR-MHH		BCH10M	5117569	●	-	2,2	14,7	5	5,5	2	
SDMW 140520 SR-RPH		BCP20M	5092135	●	-	2,2	14,7	5	5,5	2	
SDMW 140520 SR-RPH		BCP25M	5092132	●	-	2,2	14,7	5	5,5	2	
SDMW 140520 SR-RPH		BCP30M	5087594	●	-	2,2	14,7	5	5,5	2	
SDMW 140520 SR-RPH		BCP35M	5081927	●	-	2,2	14,7	5	5,5	2	
SDMW 140520 SR-RKH		BCK15M	5087596	●	-	2,2	14,7	5	5,5	2	
SDMW 140520 SR-RKH		BCK20M	5081928	●	-	2,2	14,7	5	5,5	2	
SDMW 140520 SR-RHH		BCH05M	5117560	●	-	2,2	14,7	5	5,5	2	
SDMW 140520 SR-RHH		BCH10M	5117564	●	-	2,2	14,7	5	5,5	2	
SDMW 140520 SR-RHH	BCH30M	5117566	●	-	2,2	14,7	5	5,5	2		
 CEDC = 4	HFC Platten/HFC inserts										
	SDMT 180630 SR-MPH	BCP25M	5117595	●	-	3,0	18,7	6	6,5	3	
	SDMT 180630 SR-MPH	BCP35M	5117594	●	-	3,0	18,7	6	6,5	3	
	SDMT 180630 SR-MMH	BCM35M	5117596	●	-	3,0	18,7	6	6,5	3	
	SDMT 180630 SR-MMH	BCM40M	5117597	●	-	3,0	18,7	6	6,5	3	
	SDMT 180630 SR-MSH	BCS35M	5171192	○	-	3,0	18,7	6	6,5	3	
	SDMT 180630 SR-MHH	BCH30M	5170536	●	-	3,0	18,7	6	6,5	3	
	SDMW 180630 SR-RPH	BCP35M	5117598	●	-	3,0	18,7	6	6,5	3	
	SDMW 180630 SR-RPH	BCP40M	5117599	●	-	3,0	18,7	6	6,5	3	
	SDMW 180630 SR-RKH	BCK15M	5118026	○	-	3,0	18,7	6	6,5	3	
	SDMW 180630 SR-RKH	BCK20M	5117600	●	-	3,0	18,7	6	6,5	3	
	SDMW 180630 SR-RHH	BCH30M	5117601	●	-	3,0	18,7	6	6,5	3	

CEDC = Anzahl der Schneidkanten CEDC = Number of cutting edges	Artikelbezeichnung Item code	Schneidstoffsorte Cutting materials	Bestell-Nr. Ordering No.	Verfügbarkeit Availability	Abmessungen [mm] Dimensions [mm]					Werkzeuge Tools
					L	IC	S	D1	RE	
 CEDC = 4	SEKN 1203 AFSN-MP	BCP25M	5080905	●	12,70	12,70	3,18	-	-	
	SEKN 1203 AFSN-MP	BCP30M	5080906	●	12,70	12,70	3,18	-	-	
	SEKN 1203 AFSN-MP	BCP35M	5080907	●	12,70	12,70	3,18	-	-	
	SEKN 1203 AFEN-MM	BCM40M	5080909	●	12,70	12,70	3,18	-	-	
	SEKN 1203 AFSN-MK	BCK15M	5080908	●	12,70	12,70	3,18	-	-	
	SEKN 1203 AFSN-MK	BCK20M	5085208	●	12,70	12,70	3,18	-	-	
	SEKN 1504 AFSN-MP	BCP20M	5106277	●	15,88	15,88	4,76	-	-	
	SEKN 1504 AFSN-MP	BCP25M	5080915	●	15,88	15,88	4,76	-	-	
	SEKN 1504 AFSN-MP	BCP30M	5080917	●	15,88	15,88	4,76	-	-	
	SEKN 1504 AFSN-MP	BCP35M	5085205	●	15,88	15,88	4,76	-	-	
	SEKN 1504 AFSN-MP	BCP40M	5092161	●	15,88	15,88	4,76	-	-	
	SEKN 1504 AFEN-MM	BCM35M	5092294	●	15,88	15,88	4,76	-	-	
	SEKN 1504 AFEN-MM	BCM40M	5080914	●	15,88	15,88	4,76	-	-	
	SEKN 1504 AFSN-MK	BCK15M	5092169	○	15,88	15,88	4,76	-	-	
 CEDC = 4	SEKT 1204 AFSN-MP	BCP20M	5085213	○	12,70	12,70	4,76	5,5	-	ISO 45P Seite, see page 54
	SEKT 1204 AFSN-MP	BCP25M	5081955	●	12,70	12,70	4,76	5,5	-	
	SEKT 1204 AFSN-MP	BCP30M	5085210	●	12,70	12,70	4,76	5,5	-	
	SEKT 1204 AFSN-MP	BCP35M	5080920	●	12,70	12,70	4,76	5,5	-	
	SEKT 1204 AFEN-MM	BCM35M	5092292	●	12,70	12,70	4,76	5,5	-	
	SEKT 1204 AFEN-MM	BCM40M	5081931	●	12,70	12,70	4,76	5,5	-	
	SEHT 1204 AFFN-ALC	BCN10M	5080918	●	12,70	12,70	4,76	5,5	-	
	SEHT 1204 AFFN-ALC	BWN10M	5080919	●	12,70	12,70	4,76	5,5	-	
	SEKT 13T3 AFSN-MP	BCP20M	5126205	●	13,4	13,4	3,97	4,2	-	
	SEKT 13T3 AFSN-MP	BCP25M	5126203	●	13,4	13,4	3,97	4,2	-	
	SEKT 13T3 AFSN-MP	BCP30M	5126200	○	13,4	13,4	3,97	4,2	-	
	SEKT 13T3 AFSN-MP	BCP35M	5126199	●	13,4	13,4	3,97	4,2	-	
	SEKT 13T3 AFEN-MM	BCM35M	5126212	●	13,4	13,4	3,97	4,2	-	
	SEKT 13T3 AFEN-MM	BCM40M	5126210	●	13,4	13,4	3,97	4,2	-	
SEHT 13T3 AZFN-MN	BCN10M	5126228	●	13,4	13,4	3,97	4,2	-		
SEHT 13T3 AZFN-MN	BWN10M	5126227	●	13,4	13,4	3,97	4,2	-		

Bestellbeispiel Order example: 10 Stück pieces 5080905 oder or SEKN 1203 AFSN-MP BCP25M

Schnittwertempfehlungen siehe Fräsen 45° Seite 76

Cutting data recommendations milling cutter 45°, see page 76

Farbliche Abbildung der WSP müssen nicht dem Original entsprechen!

Colours of the original indexable inserts may deviate from the illustration!

● Verfügbar ab Lager Available from stock

○ Lieferzeit auf Anfrage

Delivery time on request

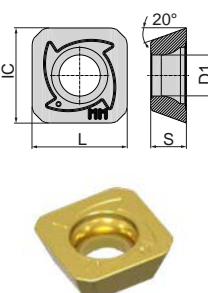
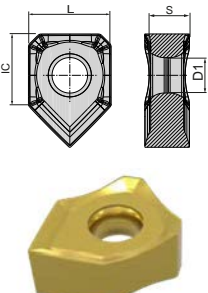
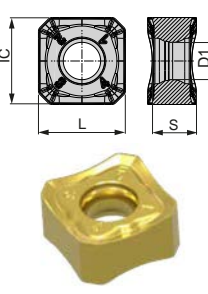
CEDC = Anzahl der Schneidkanten CEDC = Number of cutting edges	Artikelbezeichnung Item code	Schneidstoffsorte Cutting materials	Bestell-Nr. Ordering No.	Verfügbarkeit Availability	Abmessungen [mm] Dimensions [mm]					Werkzeuge Tools
					L	IC	S	D1	RE	
 <p>CEDC = 4</p>	SEKW 1204 AFSN-MP	BCP25M	5080939	●	12,70	12,70	4,76	5,5	-	ISO 45P Seite, see page 54
	SEKW 1204 AFSN-MP	BCP30M	5080941	●	12,70	12,70	4,76	5,5	-	
	SEKW 1204 AFSN-MP	BCP35M	5081933	●	12,70	12,70	4,76	5,5	-	
	SEKW 1204 AFSN-MP	BCP40M	5092177	●	12,70	12,70	4,76	5,5	-	
	SEKW 1204 AFEN-MM	BCM40M	5080931	●	12,70	12,70	4,76	5,5	-	
	SEKW 1204 AFSN-MK	BCK15M	5080982	●	12,70	12,70	4,76	5,5	-	
	SEKW 1204 AFSN-MK	BCK20M	5081934	●	12,70	12,70	4,76	5,5	-	
	SEKW 13T3 AFSN-MP	BCP25M	5126221	●	13,4	13,4	3,97	4,2	-	
	SEKW 13T3 AFSN-MP	BCP30M	5126217	●	13,4	13,4	3,97	4,2	-	
	SEKW 13T3 AFSN-MP	BCP35M	5126214	●	13,4	13,4	3,97	4,2	-	
	SEKW 13T3 AFSN-MP	BCP40M	5126213	●	13,4	13,4	3,97	4,2	-	
	SEKW 13T3 AFEN-MM	BCM40M	5126220	●	13,4	13,4	3,97	4,2	-	
	SEKW 13T3 AFSN-MK	BCK15M	5126223	●	13,4	13,4	3,97	4,2	-	
	SEKW 13T3 AFSN-MK	BCK20M	5126222	●	13,4	13,4	3,97	4,2	-	
 <p>CEDC = 2</p>	SNEX 1206-FW	BCM35M	5090743	●	12,70	12,70	5,8	5,45	-	THETAtec 45N Seite, see page 62
 <p>CEDC = 8</p>	SNMX 1206 ANSN-MP	BCP20M	5092061	●	12,70	12,70	5,8	5,45	-	
	SNMX 1206 ANSN-MP	BCP25M	5081869	●	12,70	12,70	5,8	5,45	-	
	SNMX 1206 ANSN-MP	BCP30M	5081870	●	12,70	12,70	5,8	5,45	-	
	SNMX 1206 ANSN-MP	BCP35M	5081011	●	12,70	12,70	5,8	5,45	-	
	SNMX 1206 ANSN-MM	BCM35M	5090093	●	12,70	12,70	6,2	5,45	-	
	SNMX 1206 ANSN-MM	BCM40M	5081872	●	12,70	12,70	6,2	5,45	-	
	SNMX 1206 ANSN-MK	BCK15M	5081013	●	12,70	12,70	5,8	5,45	-	
	SNMX 1206 ANSN-MK	BCK20M	5081012	●	12,70	12,70	5,8	5,45	-	
	SNHX 1206 ANFN-MN	BCN10M	5141461	●	12,70	12,70	6,2	5,45	-	
	SNHX 1206 ANFN-MN	BWN10M	5141458	●	12,70	12,70	6,2	5,45	-	
SNMX 1206 ANSN-MS	BCS35M	5162141	●	12,70	12,70	6,2	5,45	-		
SNMX 1206 ANSN-MS	BCS40M	5168101	●	12,70	12,70	6,2	5,45	-		

Bestellbeispiel Order example: 10 Stück pieces 5080939 oder or SEKW 1204 AFSN-MP BCP25M
Schnittwertempfehlungen siehe Fräsen 45° Seite 76
Cutting data recommendations milling cutter 45°, see page 76
Sortenübersicht Seite 6
Grade overview, see page 6

CEDC = Anzahl der Schneidkanten CEDC = Number of cutting edges	Artikelbezeichnung Item code	Schneidstoffsorte Cutting materials	Bestell-Nr. Ordering No.	Verfügbarkeit Availability	Abmessungen [mm] Dimensions [mm]					Werkzeuge Tools
					L	IC	S	D1	RE	
<p>CEDC = 8</p>	SNMX 120608 SN-MP	BCP30M	5081873	●	12,70	12,70	5,8	5,45	0,8	THETatec 88N Seite, see page 128
	SNMX 120608 SN-MP	BCP35M	5081014	●	12,70	12,70	5,8	5,45	0,8	
	SNMX 120608 SN-MM	BCM40M	5081871	●	12,70	12,70	6,2	5,45	0,8	
	SNMX 120608 SN-MK	BCK15M	5085128	●	12,70	12,70	5,8	5,45	0,8	
	SNMX 120608 SN-MK	BCK20M	5081875	●	12,70	12,70	5,8	5,45	0,8	
	SNMX 120612 SN-MP	BCP30M	5085133	●	12,70	12,70	5,8	5,45	1,2	
	SNMX 120612 SN-MP	BCP35M	5085131	●	12,70	12,70	5,8	5,45	1,2	
	SNMX 120612 SN-MK	BCK15M	5085136	●	12,70	12,70	5,8	5,45	1,2	
	SNMX 120612 SN-MK	BCK20M	5085135	●	12,70	12,70	5,8	5,45	1,2	
<p>CEDC = 4</p>	SPET 1204ADSN-MP	BCP35M	5153561	●	12,70	12,70	4,76	5,5	-	
<p>CEDC = 4</p>	SPKN 1203 EDSR-MP	BCP20M	5096940	○	12,70	12,70	3,18	-	-	
	SPKN 1203 EDSR-MP	BCP25M	5096944	○	12,70	12,70	3,18	-	-	
	SPKN 1203 EDSR-MP	BCP30M	5096928	○	12,70	12,70	3,18	-	-	
	SPKN 1203 EDSR-MP	BCP35M	5094542	○	12,70	12,70	3,18	-	-	
	SPKN 1203 EDSR-MK	BCK15M	5096946	○	12,70	12,70	3,18	-	-	
	SPKN 1203 EDSR-MK	BCK20M	5096950	○	12,70	12,70	3,18	-	-	
	SPKN 1504 EDSR-MP	BCP20M	5096956	○	15,88	15,88	4,76	-	-	
	SPKN 1504 EDSR-MP	BCP25M	5096958	○	15,88	15,88	4,76	-	-	
	SPKN 1504 EDSR-MP	BCP30M	5096953	○	15,88	15,88	4,76	-	-	
	SPKN 1504 EDSR-MP	BCP35M	5094543	○	15,88	15,88	4,76	-	-	
	SPKN 1504 EDSR-MK	BCK15M	5094544	○	15,88	15,88	4,76	-	-	
	SPKN 1504 EDSR-MK	BCK20M	5096968	○	15,88	15,88	4,76	-	-	
	SPKN 2506 DZSR-MP	BCP30M	5096970	●	25,4	25,4	6,35	-	-	
	SPKN 2506 DZSR-MP	BCP35M	5096971	●	25,4	25,4	6,35	-	-	

Bestellbeispiel Order example: 10 Stück pieces 5081873 oder or SNMX 120608 SN-MP BCN10M

Schnittwertempfehlungen siehe Fräsen 90° Seite 130

Cutting data recommendations milling cutter 90°, see page 130

Farbliche Abbildung der WSP müssen nicht dem Original entsprechen!

Colours of the original indexable inserts may deviate from the illustration!

● Verfügbar ab Lager Available from stock

○ Lieferzeit auf Anfrage

Delivery time on request

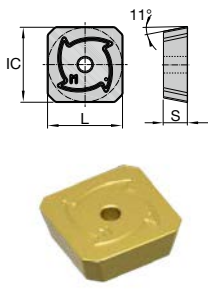
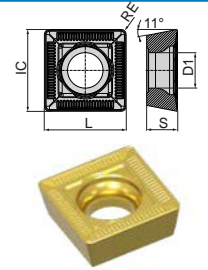
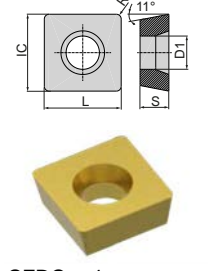
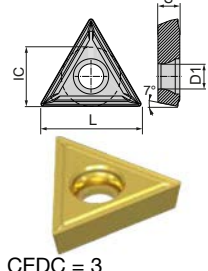
CEDC = Anzahl der Schneidkanten CEDC = Number of cutting edges	Artikelbezeichnung Item code	Schneidstoffsorte Cutting materials	Bestell-Nr. Ordering No.	Verfügbarkeit Availability	Abmessungen [mm] Dimensions [mm]					Werkzeuge Tools
					L	IC	S	D1	RE	
 <p>CEDC = 4</p>	SPKN 2006 ADSN	BCP20M	5173433	○	20	20	6,35	-	-	BULLtec Seite, see page 71
	SPKN 2006 ADSN	BCP25M	5190694	●	20	20	6,35	-	-	
	SPKN 2006 ADSN	BCP30M	5190697	○	20	20	6,35	-	-	
	SPKN 2006 ADSN	BCP35M	5137986	●	20	20	6,35	-	-	
	SPKN 2006 ADSN	BCM40M	5137989	●	20	20	6,35	-	-	
	SPKN 2006 ADSN	BCK15M	5190708	○	20	20	6,35	-	-	
	SPKN 2006 ADSN	BCK20M	5176323	●	20	20	6,35	-	-	
	SPKN 2006 ADSN	BCS35M	5209360	○	20	20	6,35	-	-	
	SPKN 2706 ADSN	BCP30M	5178730	○	27	27	6,35	-	-	
	SPKN 2706 ADSN	BCP35M	5138422	●	27	27	6,35	-	-	
 <p>CEDC = 4</p>	SPMT 060304	BCP30M	5080993	●	6,35	6,35	3,18	2,8	0,4	
	SPMT 120408-SN	BCP30M	5080994	●	12,70	12,70	4,76	5,5	0,8	
	SPMT 120408-SN	BCP35M	5080995	●	12,70	12,70	4,76	5,5	0,8	
 <p>CEDC = 4</p>	SPMW 120408	BCK15M	5080996	●	12,70	12,70	4,76	5,5	0,8	
 <p>CEDC = 3</p>	TCMT 110202 EN	BCP25M	5126233	●	10,4	6,35	2,38	2,8	0,2	ISO Chamfer Seite, see page 50
	TCMT 16T304 EN	BCP25M	5126235	●	15,5	9,52	3,97	4,4	0,4	
	TCMT 16T304 EN	BCK20M	5165006	○	15,5	9,52	3,97	4,4	0,4	

Bestellbeispiel Order example: 10 Stück pieces 5173433 oder or SPKN 2006 ADSN BCP20M

Schnittwertempfehlungen Fräser 45° siehe Seite 76

Cutting data recommendations milling cutter 45°, see page 76

Sortenübersicht Seite 6

Grade overview, see page 6

CEDC = Anzahl der Schneidkanten CEDC = Number of cutting edges	Artikelbezeichnung Item code	Schneidstoffsorte Cutting materials	Bestell-Nr. Ordering No.	Verfügbarkeit Availability	Abmessungen [mm] Dimensions [mm]						Werkzeuge Tools
					W1	LE	IC	S	D1	RE	
	TE 0805-SHF	BCH10M	5187724	○	7	1,5	8	2,4	2,5	0,5	TORROtec Seite, see page 134
	TE 0810-SHF	BCH10M	5136374	●	7	2	8	2,4	2,5	1	
	TE 1005-SHF	BCH10M	5143786	●	8,5	1,5	10	2,6	3	0,5	
	TE 1010-SHF	BCH10M	5136385	●	8,5	2	10	2,6	3	1	
	TE 1015-SHF	BCH10M	5143787	○	8,5	2,5	10	2,6	3	1,5	
	TE 1205-SHF	BCH10M	5143790	●	10	1,5	12	3	3,5	0,5	
	TE 1210-SHF	BCH10M	5136390	●	10	2	12	3	3,5	1	
	TE 1215-SHF	BCH10M	5143791	○	10	2,5	12	3	3,5	1,5	
	TE 1220-SHF	BCH10M	5136391	○	10	3	12	3	3,5	2	
	TE 1605-SHF	BCH10M	5143793	○	12	1,5	16	4	4	0,5	
	TE 1610-SHF	BCH10M	5136396	●	12	2	16	4	4	1	
	TE 1615-SHF	BCH10M	5143794	○	12	2,5	16	4	4	1,5	
	TE 1630-SHF	BCH10M	5136397	●	12	4	16	4	4	3	
	TE 2010-SHF	BCH10M	5136402	●	15	2	20	5	5	1	
	TE 2040-SHF	BCH10M	5136403	○	15	5	20	5	5	4	
	TE 2510-SHF	BCH10M	5136413	●	18,5	2	25	6	6	1	
TE 2550-SHF	BCH10M	5136414	○	18,5	6	25	6	6	5		
CEDC = 2											
	TE 0805-MHN	BCH10M	5152007	○	7	1,5	8	2,4	2,5	0,5	
	TE 0806-MHN	BCH10M	5136378	○	7	1,6	8	2,4	2,5	0,6	
	TE 0810-MHN	BCH10M	5136381	○	7	2	8	2,4	2,5	1	
	TE 0820-MHN	BCH10M	5152010	○	7	3	8	2,4	2,5	2,0	
	TE 1005-MHN	BCH10M	5136386	○	8,5	1,5	10	2,6	3	0,5	
	TE 1008-MHN	BCH10M	5136387	●	8,5	1,8	10	2,6	3	0,8	
	TE 1010-MHN	BCH10M	5136388	●	8,5	2	10	2,6	3	1	
	TE 1015-MHN	BCH10M	5143789	○	8,5	2,5	10	2,6	3	1,5	
	TE 1020-MHN	BCH10M	5213044	○	8,5	3	10	2,6	3	2	
	TE 1205-MHN	BCH10M	5136392	●	10	1,5	12	3	3,5	0,5	
	TE 1210-MHN	BCH10M	5136393	●	10	2	12	3	3,5	1	
	TE 1215-MHN	BCH10M	5143792	○	10	2,5	12	3	3,5	1,5	
	TE 1220-MHN	BCH10M	5136394	○	10	3	12	3	3,5	2	
	TE 1605-MHN	BCH10M	5143795	○	12	1,5	16	4	4	0,5	
	TE 1610-MHN	BCH10M	5136399	●	12	2	16	4	4	1	
	TE 1615-MHN	BCH10M	5143796	○	12	2,5	16	4	4	1,5	
TE 1630-MHN	BCH10M	5136400	●	12	4	16	4	4	3		
TE 2010-MHN	BCH10M	5136404	●	15	2	20	5	5	1		
TE 2040-MHN	BCH10M	5136409	●	15	5	20	5	5	4		
TE 2510-MHN	BCH10M	5136415	○	18,5	2	25	6	6	1		
TE 2550-MHN	BCH10M	5136417	○	18,5	6	25	6	6	5		
CEDC = 2											

Bestellbeispiel Order example: 10 Stück pieces 5136374 oder or TE 0810-SHF BCH10M
 Schnitwertempfehlungen 3D Fräsen siehe Seite 174
 Cutting data recommendations 3D milling, see page 174
 Farbliche Abbildung der WSP müssen nicht dem Original entsprechen!
 Colours of the original indexable inserts may deviate from the illustration!

- Verfügbar ab Lager Available from stock
- Lieferzeit auf Anfrage Delivery time on request

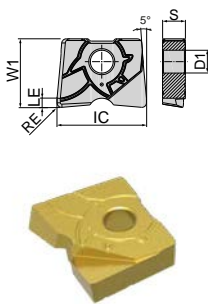
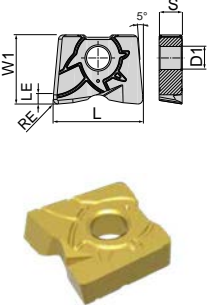
CEDC = Anzahl der Schneidkanten CEDC = Number of cutting edges	Artikelbezeichnung Item code	Schneidstoffsorte Cutting materials	Bestell-Nr. Ordering No.	Verfügbarkeit Availability	Abmessungen [INCH] Dimensions [INCH]						Werkzeuge Tools
					W1	LE	IC	S	D1	RE	
 <p>CEDC = 2</p>	TE 03120015-SHF	BCH10M	5151517	○	0.273	0.054	0.312	0.094	0.098	0.015	TORROtec Seite, see page 134
	TE 03120031-SHF	BCH10M	5151519	○	0.273	0.070	0.312	0.094	0.098	0.031	
	TE 03120062-SHF	BCH10M	5151520	○	0.273	0.100	0.312	0.094	0.098	0.062	
	TE 03750015-SHF	BCH10M	5151524	○	0.324	0.054	0.375	0.102	0.119	0.015	
	TE 03750031-SHF	BCH10M	5151525	●	0.324	0.070	0.375	0.102	0.119	0.031	
	TE 03750062-SHF	BCH10M	5151526	●	0.324	0.100	0.375	0.102	0.119	0.062	
	TE 05000015-SHF	BCH10M	5151532	○	0.406	0.054	0.500	0.119	0.138	0.015	
	TE 05000031-SHF	BCH10M	5151533	●	0.406	0.070	0.500	0.119	0.138	0.031	
	TE 05000062-SHF	BCH10M	5151534	●	0.406	0.100	0.500	0.119	0.138	0.062	
	TE 06250031-SHF	BCH10M	5151541	○	0.468	0.070	0.625	0.157	0.157	0.031	
	TE 06250062-SHF	BCH10M	5151542	○	0.468	0.100	0.625	0.157	0.157	0.062	
	TE 06250125-SHF	BCH10M	5151543	○	0.468	0.165	0.625	0.157	0.157	0.125	
	TE 07500031-SHF	BCH10M	5147182	●	0.570	0.070	0.750	0.197	0.197	0.031	
	TE 07500062-SHF	BCH10M	5151548	●	0.570	0.100	0.750	0.197	0.197	0.062	
	TE 07500125-SHF	BCH10M	5151549	○	0.570	0.165	0.750	0.197	0.197	0.125	
	TE 10000031-SHF	BCH10M	5151553	●	0.732	0.070	1.000	0.236	0.236	0.031	
	TE 10000062-SHF	BCH10M	5151554	●	0.732	0.100	1.000	0.236	0.236	0.062	
	TE 10000125-SHF	BCH10M	5151556	○	0.732	0.165	1.000	0.236	0.236	0.125	
TE 10000250-SHF	BCH10M	5151557	○	0.732	0.290	1.000	0.236	0.236	0.250		
 <p>CEDC = 2</p>	TE 03120015-MHN	BCH10M	5151521	○	0.273	0.054	0.312	0.094	0.098	0.015	TORROtec Seite, see page 134
	TE 03120031-MHN	BCH10M	5151522	○	0.273	0.070	0.312	0.094	0.098	0.031	
	TE 03120062-MHN	BCH10M	5151523	○	0.273	0.100	0.312	0.094	0.098	0.062	
	TE 03750015-MHN	BCH10M	5151527	○	0.324	0.054	0.375	0.102	0.118	0.015	
	TE 03750031-MHN	BCH10M	5151528	○	0.324	0.070	0.375	0.102	0.118	0.031	
	TE 03750062-MHN	BCH10M	5151529	●	0.324	0.100	0.375	0.102	0.118	0.063	
	TE 05000015-MHN	BCH10M	5151535	○	0.406	0.054	0.500	0.119	0.138	0.015	
	TE 05000031-MHN	BCH10M	5151537	●	0.406	0.070	0.500	0.119	0.138	0.031	
	TE 05000062-MHN	BCH10M	5151538	●	0.406	0.100	0.500	0.119	0.138	0.062	
	TE 06250031-MHN	BCH10M	5151544	○	0.470	0.070	0.625	0.157	0.157	0.031	
	TE 06250062-MHN	BCH10M	5151545	○	0.470	0.100	0.625	0.157	0.157	0.062	
	TE 06250125-MHN	BCH10M	5151546	○	0.470	0.165	0.625	0.157	0.157	0.125	
	TE 07500031-MHN	BCH10M	5147184	●	0.570	0.070	0.750	0.197	0.197	0.031	
	TE 07500062-MHN	BCH10M	5151551	●	0.570	0.100	0.750	0.197	0.197	0.062	
	TE 07500125-MHN	BCH10M	5151552	○	0.570	0.165	0.750	0.197	0.197	0.125	
	TE 10000031-MHN	BCH10M	5151558	●	0.736	0.070	1.000	0.236	0.236	0.031	
	TE 10000062-MHN	BCH10M	5151559	●	0.736	0.100	1.000	0.236	0.236	0.062	
	TE 10000125-MHN	BCH10M	5151560	○	0.736	0.165	1.000	0.236	0.236	0.125	
TE 10000250-MHN	BCH10M	5151561	○	0.736	0.290	1.000	0.236	0.236	0.250		

Bestellbeispiel Order example: 10 Stück pieces 5151517 oder or TE 03120015-SHF BCH10M

Schnittwertempfehlungen 3D Fräsen siehe Seite 174

Cutting data recommendations 3D milling, see page 174

Sortenübersicht Seite 6





Grade overview, see page 6

CEDC = Anzahl der Schneidkanten CEDC = Number of cutting edges	Artikelbezeichnung Item code	Schneidstoffsorte Cutting materials	Bestell-Nr. Ordering No.	Verfügbarkeit Availability	Abmessungen [mm] Dimensions [mm]			Werkzeuge Tools	
					L	IC	S		
 CEDC = 6	TNHF 1204 ANSN-BK	BCK20M	5080997	●	12	12,70	4,63		
 CEDC = 3	TPKN 1603 PDSR-MP	BCP20M	5096882	○	16	9,52	3,18		
	TPKN 1603 PDSR-MP	BCP25M	5096884	○	16	9,52	3,18		
	TPKN 1603 PDSR-MP	BCP30M	5096865	○	16	9,52	3,18		
	TPKN 1603 PDSR-MP	BCP35M	5094545	○	16	9,52	3,18		
	TPKN 1603 PDSR-MK	BCK15M	5096888	○	16	9,52	3,18		
	TPKN 1603 PDSR-MK	BCK20M	5096890	○	16	9,52	3,18		
	TPKN 2204 PDSR-MP	BCP20M	5096906	○	22	12,70	4,76		
	TPKN 2204 PDSR-MP	BCP25M	5096908	○	22	12,70	4,76		
	TPKN 2204 PDSR-MP	BCP30M	5096896	○	22	12,70	4,76		
	TPKN 2204 PDSR-MP	BCP35M	5094546	○	22	12,70	4,76		
	TPKN 2204 PDSR-MK	BCK15M	5096917	○	22	12,70	4,76		
	TPKN 2204 PDSR-MK	BCK20M	5096921	○	22	12,70	4,76		
 CEDC = 3	TPLN3106 ADSN	BCP30M	5190714	○	31,75	18	6,35		
	TPLN 3106 ADSN	BCP35M	5138420	●	31,75	18	6,35		
	TPLN 3106 ADSN	BCP40M	5138421	○	31,75	18	6,35		
	TPLN 3106 ADSN	BCM40M	5081021	●	31,75	18	6,35		

BULLtec
Seite, see page 71

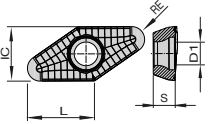
Bestellbeispiel Order example: 10 Stück pieces 5080997 oder or TNHF 1204 ANSN-BK BCK20M
 Schnittwertempfehlungen Fräser 45° siehe Seite 76
 Cutting data recommendations milling cutter 45°, see page 76
 Farbliche Abbildung der WSP müssen nicht dem Original entsprechen!
 Colours of the original indexable inserts may deviate from the illustration!

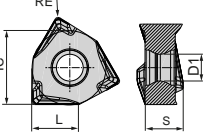
● Verfügbar ab Lager Available from stock
 ○ Lieferzeit auf Anfrage
 Delivery time on request

CEDC = Anzahl der Schneidkanten CEDC = Number of cutting edges	Artikelbezeichnung Item code	Schneidstoffsorte Cutting materials	Bestell-Nr. Ordering No.	Verfügbarkeit Availability	Abmessungen [mm] Dimensions [mm]					Werkzeuge Tools
					L	IC	S	D1	RE	
  CEDC = 2	VCGT 220530-MN	BCN10M	5173009	●	22,10	12,70	5,56	5,5	3,0	ISO Plunge 90P Seite, see page 151
	VCGT 220530-MN	BWN10M	5173008	●	22,10	12,70	5,56	5,5	3,0	
  CEDC = 6	WNEX 040304-MP	BCP20M	5145419	●	4	6,7	3,32	3,05	0,4	ZETAtec 90N Seite, see page 124
	WNEX 040304-MP	BCP25M	5125085	●	4	6,7	3,32	3,05	0,4	
	WNEX 040304-MP	BCP30M	5145420	○	4	6,7	3,32	3,05	0,4	
	WNEX 040304-MP	BCP35M	5125086	●	4	6,7	3,32	3,05	0,4	
	WNEX 040304-MM	BCM35M	5125087	●	4	6,7	3,32	3,05	0,4	
	WNEX 040304-MM	BCM40M	5145421	●	4	6,7	3,32	3,05	0,4	
	WNEX 040304-MK	BCK15M	5145422	○	4	6,7	3,32	3,05	0,4	
	WNEX 040304-MK	BCK20M	5125088	●	4	6,7	3,32	3,05	0,4	
	WNEX 040304-MH	BCH05M	5145423	○	4	6,7	3,32	3,05	0,4	
	WNEX 040304-MH	BCH10M	5145424	●	4	6,7	3,32	3,05	0,4	
	WNEX 040308-MP	BCP25M	5166013	○	4	6,7	3,32	3,05	0,8	
	WNEX 040308-MP	BCP35M	5166014	●	4	6,7	3,32	3,05	0,8	
	WNEX 040308-MM	BCM35M	5166015	○	4	6,7	3,32	3,05	0,8	
	WNEX 040308-MM	BCM40M	5166016	●	4	6,7	3,32	3,05	0,8	
	WNEX 040308-MK	BCK20M	5166017	●	4	6,7	3,32	3,05	0,8	
	WNEX040308-MH	BCH10M	5166018	●	4	6,7	3,32	3,05	0,8	
	WNEX 080608-RP	BCP20M	5142996	●	8	12,5	6,55	4,6	0,8	
	WNEX 080608-RP	BCP25M	5099627	●	8	12,5	6,55	4,6	0,8	
	WNEX 080608-RP	BCP30M	5142997	●	8	12,5	6,55	4,6	0,8	
	WNEX 080608-RP	BCP35M	5098314	●	8	12,5	6,55	4,6	0,8	
	WNEX 080608-RP	BCP40M	5142998	●	8	12,5	6,55	4,6	0,8	
	WNEX 080608-RM	BCM35M	5099629	●	8	12,5	6,55	4,6	0,8	
	WNEX 080608-RM	BCM40M	5117593	●	8	12,5	6,55	4,6	0,8	
	WNEX 080608-RK	BCK15M	5142999	●	8	12,5	6,55	4,6	0,8	
	WNEX 080608-RK	BCK20M	5104081	●	8	12,5	6,55	4,6	0,8	
	WNEX 080608-MN	BCN10M	5117591	●	8	12,5	6,55	4,6	0,8	
	WNEX 080608-MN	BWN10M	5117589	●	8	12,5	6,55	4,6	0,8	
	WNEX 080608-MH	BCH05M	5143000	●	8	12,5	6,55	4,6	0,8	
	WNEX 080608-MH	BCH10M	5143003	●	8	12,5	6,55	4,6	0,8	
	WNEX 080608-MH	BCH30M	5174381	○	8	12,5	6,55	4,6	0,8	
WNEX 080612-RP	BCP25M	5166020	○	8	12,5	6,55	4,6	1,2		
WNEX 080612-RP	BCP35M	5166021	●	8	12,5	6,55	4,6	1,2		
WNEX 080612-RM	BCM35M	5166022	○	8	12,5	6,55	4,6	1,2		
WNEX 080612-RM	BCM40M	5166023	●	8	12,5	6,55	4,6	1,2		
WNEX 080612-RK	BCK20M	5166024	●	8	12,5	6,55	4,6	1,2		
WNEX 080612-MH	BCH10M	5166025	○	8	12,5	6,55	4,6	1,2		

Bestellbeispiel Order example: 10 Stück pieces 5173009 oder or VCGT 220530-MN BCN10M

Schnittwertempfehlungen siehe Fräsen 90° Seite 130

Cutting data recommendations milling cutter 90°, see page 130

Schnittwertempfehlungen 3D Fräsen siehe Seite 174

Cutting data recommendations 3D milling, see page 174

Sortenübersicht Seite 6

Grade overview, see page 6

CEDC = Anzahl der Schneidkanten CEDC = Number of cutting edges	Artikelbezeichnung Item code	Schneidstoffsorte Cutting materials	Bestell-Nr. Ordering No.	Verfügbarkeit Availability	Abmessungen [mm] Dimensions [mm]					Werkzeuge Tools
					L	IC	S	D1	RE	
<p>CEDC = 7</p>	XEMT 040408-MP	BCP20M	5103790	●	4	12,7	4,76	4,6	0,8	ETAtec 45P Seite, see page 58
	XEMT 040408-MP	BCP25M	5103792	●	4	12,7	4,76	4,6	0,8	
	XEMT 040408-MP	BCP30M	5103789	●	4	12,7	4,76	4,6	0,8	
	XEMT 040408-MP	BCP35M	5103788	●	4	12,7	4,76	4,6	0,8	
	XEMT 040408-MM	BCM35M	5103797	●	4	12,7	4,76	4,6	0,8	
	XEMT 040408-MM	BCM40M	5103799	●	4	12,7	4,76	4,6	0,8	
	XEHT 040408-MN	BCN10M	5141454	●	4	12,7	4,76	4,6	0,8	
	XEHT 040408-MN	BWN10M	5141453	●	4	12,7	4,76	4,6	0,8	
	XEGT 040408-MT	BCS35M	5120324	●	4	12,7	4,76	4,6	0,8	
<p>CEDC = 7</p>	XEMW 040408-MP	BCP25M	5103815	●	4	12,7	4,76	4,6	0,8	
	XEMW 040408-MP	BCP30M	5103813	●	4	12,7	4,76	4,6	0,8	
	XEMW 040408-MP	BCP35M	5103811	●	4	12,7	4,76	4,6	0,8	
	XEMW 040408-MP	BCP40M	5103814	●	4	12,7	4,76	4,6	0,8	
	XEMW 040408-MM	BCM40M	5103903	●	4	12,7	4,76	4,6	0,8	
	XEMW 040408-MK	BCK20M	5103816	●	4	12,7	4,76	4,6	0,8	
	XEMW 040408-MH	BCH05M	5117576	●	4	12,7	4,76	4,6	0,8	
	XEMW 040408-MH	BCH10M	5117579	●	4	12,7	4,76	4,6	0,8	

Bestellbeispiel Order example: 10 Stück pieces 5103790 oder or XEMT 040408-MP BCP20M

Schnittwertempfehlungen Fräser 45° siehe Seite 76

Cutting data recommendations milling cutter 45°, see page 76

Sortenübersicht Seite 6

Grade overview, see page 6

Farbliche Abbildung der WSP müssen nicht dem Original entsprechen!

Colours of the original indexable inserts may deviate from the illustration!

- Verfügbar ab Lager Available from stock
- Lieferzeit auf Anfrage Delivery time on request

Fräskompetenz
auf ganzer Linie
Milling competence
right down the line



- Kontaktieren Sie uns jetzt! Unsere kompetenten Mitarbeiter beraten Sie gerne und unterstützen Sie bei der Umsetzung Ihrer Projekte.
- Contact us now! Our competent staff will be happy to advise you and support you in the implementation of your projects.

Planfräsen 45°
Face milling 45°



	ISO Chamfer 30°	ISO Chamfer 45°	ISO Chamfer 60°
Ausführung Execution			
Plattengröße Insert size	TC.. 16	TC.. 11, TC.. 16	TC.. 11, TC.. 16

Besondere Merkmale:

- Auswahl von verschiedenen Anstellwinkeln möglich
- Schneidstoffe speziell auf die Bearbeitung abgestimmt
- Universelles Werkzeug zur Fas- und Entgratbearbeitung

Special features:

- Different approach angles available
- Optimized grades for each application
- Universal tool for chamfering and deburring

WSP Geometrie Insert geometry	TCMT 11		TCMT 16	
	Schnitttiefe* Cutting depth* [mm] APMX max	Vorschub* Feed* [mm] f _z	Schnitttiefe* Cutting depth* [mm] APMX max	Vorschub* Feed* [mm] f _z
EN	*	0,1 0,3 0,5	*	0,2 0,4 0,6
EN	*	0,1 0,3 0,5	*	0,2 0,4 0,6

* max. Schnitttiefe abhängig von Fräsgrundkörper

* max. depth of cut relating to tool holder

Schnittwertempfehlungen siehe Seite 76

Cutting data recommendations page 76

* Angegebene Schnittdaten sind als Richtwert zu sehen, welche durch Versuche für jeden Anwendungsfall separat optimiert werden können.

* Recommended cutting data has to be seen as a reference which can be optimised for each application through trials separately.

ISO Chamfer

Systemgröße 11 System size 11



ISO Chamfer 45° / TC.. 11

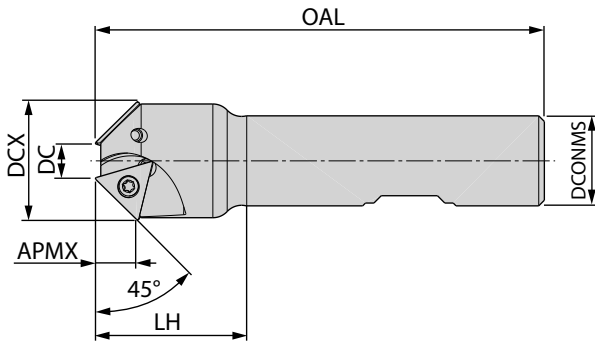

Abmessungen [mm] Dimensions [mm]							Artikelbezeichnung Item code	Schaft Shank	Bestell-Nr. Ordering-No	Verfügbarkeit Availability	Ersatzteile Spare parts			
DC	DCX	DCONMS	OAL	APMX	LH	ZEFF					AP13-25063 5138229 M _A = 3Nm	IP8 5088519		
1,2	15	12	70	7,3	25	1	BE45 TC11.0012 Z01 070	HB	5126945	●				
6,2	21	16	80	7,3	27	2	BE45 TC11.0062 Z02 080	HB	5126946	●				
6,2	21	16	150	7,3	27	2	BE45 TC11.0062 Z01 150	HA	5126948	●				

ISO Chamfer 60° / TC.. 11

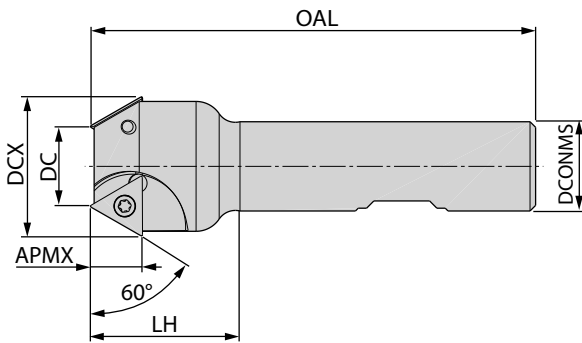

Abmessungen [mm] Dimensions [mm]							Artikelbezeichnung Item code	Schaft Shank	Bestell-Nr. Ordering-No	Verfügbarkeit Availability	Ersatzteile Spare parts			
DC	DCX	DCONMS	OAL	APMX	LH	ZEFF					AP13-25063 5138229 M _A = 3Nm	IP8 5088519		
5,4	16	12	70	8,8	25	1	BE60 TC11.0054 Z01 070	HB	5126950	●				
14,4	24	16	80	8,8	27	2	BE60 TC11.0144 Z02 080	HB	5126951	●				
14,4	24	16	150	8,8	27	2	BE60 TC11.0144 Z02 150	HA	5126953	●				

Bestellbeispiel Order example: 1 Stück piece 5126945 oder or BE45 TC11.0012 Z01 070

CEDC = Anzahl der Schneidkanten CEDC = Number of cutting edges	Artikelbezeichnung Item code	Schneidstoffsorte Cutting materials	Bestell-Nr. Ordering No.	Verfügbarkeit Availability	Abmessungen [mm] Dimensions [mm]				
					L	IC	S	D1	RE
 CEDC = 3	TCMT 110202 EN	BCP25M	5126233	●	10,4	6,35	2,38	2,8	0,2

Bestellbeispiel Order example: 1 Stück pieces 5126945 oder or BE45 TC11.0012 Z01 070

Abbildung der Wendeschneiplatten können vom Lagerartikel in Ausführung und Farbe abweichen!
Colours and execution of the original indexable inserts, may deviate from the illustration!

- Verfügbar ab Lager Available from stock
- kurzfristig lieferbar available at short notice

ISO Chamfer

Systemgröße 16 System size 16

www.boehlerit.com

ISO Chamfer 30° / TC.. 16

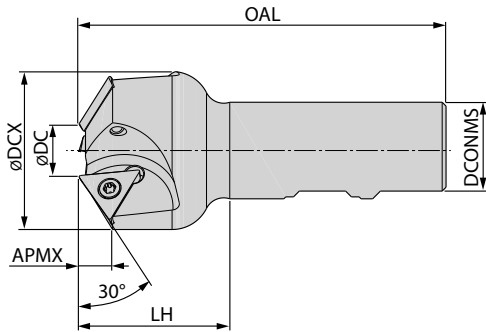

Abmessungen [mm] Dimensions [mm]							Artikelbezeichnung Item code	Schaft Shank	Bestell-Nr. Ordering-No	Verfügbarkeit Availability	Ersatzteile Spare parts	
DC	DCX	DCONMS	LH	OAL	APMX	ZEFF						
6	32	25	38	100	7,5	2	BE30 TC16.006 Z02 100	HB	5161427	●	AP13-40110 5084084 M _A = 3Nm	IP15 5088520
16	42,5	25	39	95	7,5	3	BE30 TC16.016 Z03 095	HB	5126944	●		

ISO Chamfer 45° / TC.. 16

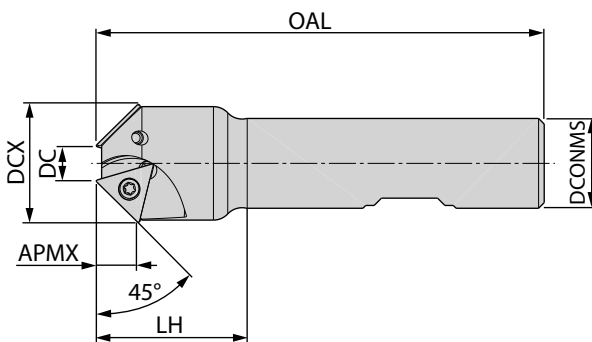

Abmessungen [mm] Dimensions [mm]							Artikelbezeichnung Item code	Schaft Shank	Bestell-Nr. Ordering-No	Verfügbarkeit Availability	Ersatzteile Spare parts	
DC	DCX	DCONMS	LH	OAL	APMX	ZEFF						
10,4	32	25	39	95	10,8	2	BE45 TC16.0104 Z02 095	HB	5126947	●	AP13-40110 5084084 M _A = 3Nm	IP15 5088520
10,4	32	25	39	150	10,8	2	BE45 TC16.0104 Z02 150	HA	5126949	●		

ISO Chamfer 60° / TC.. 16

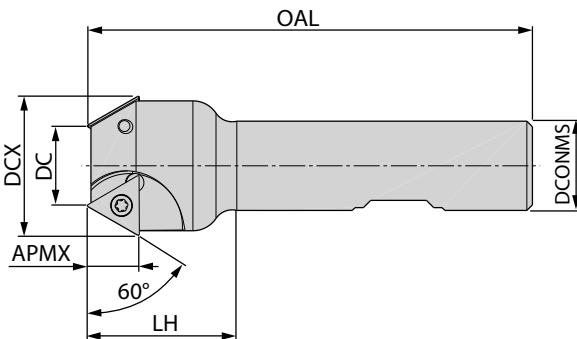

Abmessungen [mm] Dimensions [mm]							Artikelbezeichnung Item code	Schaft Shank	Bestell-Nr. Ordering-No	Verfügbarkeit Availability	Ersatzteile Spare parts	
DC	DCX	DCONMS	LH	OAL	APMX	ZEFF						
17	32	25	39	95	13,2	2	BE60 TC16.017 Z02 095	HB	5126952	●	AP13-40110 5084084 M _A = 3Nm	IP15 5088520
17	32	25	39	150	13,2	2	BE60 TC16.017 Z02 150	HA	5126954	●		

Bestellbeispiel Order example: 1 Stück piece 5161427 oder or BE30 TC16.006 Z02 100

ISO Chamfer

Systemgröße 16 System size 16

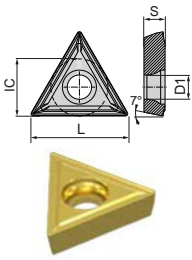

CEDC = Anzahl der Schneidkanten CEDC = Number of cutting edges	Artikelbezeichnung Item code	Schneidstoffsorte Cutting materials	Bestell-Nr. Ordering No.	Verfügbarkeit Availability	Abmessungen [mm] Dimensions [mm]					
					L	IC	S	D1	RE	
 <p>CEDC = 3</p>	TCMT 16T304 EN	BCP25M	5126235	●	15,5	9,52	3,97	4,4	0,4	
	TCMT 16T304 EN	BCK20M	5165006	○	15,5	9,52	3,97	4,4	0,4	

Bestellbeispiel Order example: 10 Stück pieces 5126235 oder or TCMT 16T304 EN BCP25M
 Abbildung der Wendeschneiplatten können vom Lagerartikel in Ausführung und Farbe abweichen!
 Colours and execution of the original indexable inserts, may deviate from the illustration!

- Verfügbar ab Lager Available from stock
- ⌚ kurzfristig lieferbar available at short notice
- Lieferzeit auf Anfrage Delivery time on request

Aufsteckfräser 45° Face milling cutter 45°	
Ausführung Execution	
Durchmesserbereich metrisch Diameter range metric	Ø 32 - 315 mm
Plattengröße Insert size	SE..12, SE..13

Besondere Merkmale:

- Positive Grundgeometrie, dadurch leicht schneidend
- 4 Schneidkanten zur Produktivitätssteigerung
- Markierung der Schneiden für exakten Rundlauf
- Durch die geringe Leistungsaufnahme, hohes Zerspanvolumen, auch auf leistungsschwachen alten Maschinen
- Ungleichteilung führt zu Schwingungsreduktion und extremer Laufruhe
- Schneidstoffvielfalt für optimale Zerspanungsergebnisse auf einem breiten Materialspektrum

Special features:

- Positive basic geometry, therefore easy cutting
- 4 cutting edges for increase of productivity
- Marking of the cutting edges for exact concentricity
- High metal removal also on inefficient old machines due to small power consumption
- Uneven spacing leads to reduced vibration and extremely smooth running
- Diversity of cutting materials for optimal cutting results on a wide material range

WSP Geometrie Insert geometry	SE.. 12, SE.. 13	
	Schnitttiefe* Cutting depth* [mm] APMX max	Vorschub* Feed* [mm] f _z
MP	1,0 4,0 6,0	0,2 0,3 0,4
MM	1,0 4,0 6,0	0,1 0,2 0,3
MK	1,0 4,0 6,0	0,2 0,3 0,4
ALC	0,7 4,0 5,0	0,1 0,2 0,3

Schnittwertempfehlungen siehe Seite 76
Cutting data recommendations page 76

* Angegebene Schnittdaten sind als Richtwert zu sehen, welche durch Versuche für jeden Anwendungsfall separat optimiert werden können.
* Recommended cutting data has to be seen as a reference which can be optimised for each application through trials separately.

Aufsteckfräser 45° / SE.. 12
Face milling cutter 45° / SE.. 12

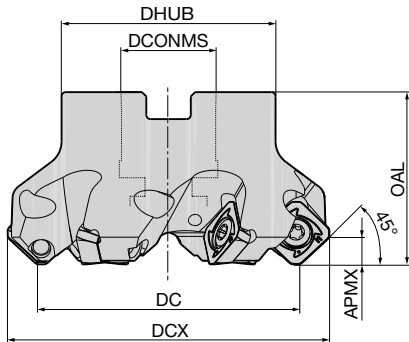

Abmessungen [mm] Dimensions [mm]							Artikelbezeichnung Item code	Bestell-Nr. Ordering No.	Verfügbarkeit Availability	Ersatzteile Spare parts	
DC	DCX	DCONMS	DHUB	OAL	APMX	ZEFF [☆]				Spannschraube Fixation screw AP13-45108 5085713 M _A = 5Nm	Torx-Schlüssel Torque wrench IP20 5088521
32	44	16	32	40	6	3	BF45 SE12.032 Z03	5142940	○		
40	53	16	32	40	6	4	BF45 SE12.040 Z04	5079243	●		
50	63	22	50	40	6	5	BF45 SE12.050 Z05	5079244	●		
63	76	22	50	40	6	5	BF45 SE12.063 Z05	5092994	●		
63	76	22	50	40	6	6	BF45 SE12.063 Z06	5079245	●		
63	76	22	50	40	6	7	BF45 SE12.063 Z07	5092995	●		
80	93	27	52	50	6	6	BF45 SE12.080 Z06	5092997	●		
80	93	27	52	50	6	7	BF45 SE12.080 Z07	5079247	●		
100	113	32	78	50	6	6	BF45 SE12.100 Z06	5092998	●		
100	113	32	78	50	6	8	BF45 SE12.100 Z08	5079248	●		
125	138	40	90	63	6	10	BF45 SE12.125 Z10	5079249	●		
160	173	40	114	63	6	12	BF45 SE12.160 Z12 NC	5093001	○		

NC = Keine Kühlung / no coolant

CEDC = Anzahl der Schneidkanten CEDC = Number of cutting edges	Artikelbezeichnung Item code	Schneidstoffsorte Cutting materials	Bestell-Nr. Ordering No.	Verfügbarkeit Availability	Abmessungen [mm] Dimensions [mm]			
					L	IC	S	D ₁
 CEDC = 4	SEKT 1204 AFSN-MP	BCP20M	5085213	○	12,70	12,70	4,76	5,5
	SEKT 1204 AFSN-MP	BCP25M	5081955	●	12,70	12,70	4,76	5,5
	SEKT 1204 AFSN-MP	BCP30M	5085210	●	12,70	12,70	4,76	5,5
	SEKT 1204 AFSN-MP	BCP35M	5080920	●	12,70	12,70	4,76	5,5
	SEKT 1204 AFEN-MM	BCM35M	5092292	●	12,70	12,70	4,76	5,5
	SEKT 1204 AFEN-MM	BCM40M	5081931	●	12,70	12,70	4,76	5,5
	SEHT 1204 AFFN-ALC	BCN10M	5080918	●	12,70	12,70	4,76	5,5
	SEHT 1204 AFFN-ALC	BWN10M	5080919	●	12,70	12,70	4,76	5,5
 CEDC = 4	SEKW 1204 AFSN-MP	BCP25M	5080939	●	12,70	12,70	4,76	5,5
	SEKW 1204 AFSN-MP	BCP30M	5080941	●	12,70	12,70	4,76	5,5
	SEKW 1204 AFSN-MP	BCP35M	5081933	●	12,70	12,70	4,76	5,5
	SEKW 1204 AFSN-MP	BCP40M	5092177	●	12,70	12,70	4,76	5,5
	SEKW 1204 AFEN-MM	BCM40M	5080931	●	12,70	12,70	4,76	5,5
	SEKW 1204 AFSN-MK	BCK15M	5080982	●	12,70	12,70	4,76	5,5
	SEKW 1204 AFSN-MK	BCK20M	5081934	●	12,70	12,70	4,76	5,5

Bestellbeispiel Order Example: 1 Stück piece 5142940 oder or BF45 SE12.032 Z03

- Verfügbar ab Lager Available from stock
- kurzfristig lieferbar available at short notice
- Lieferzeit auf Anfrage Delivery time on request

ISO 45P

Systemgröße 13 System size 13

www.boehlerit.com

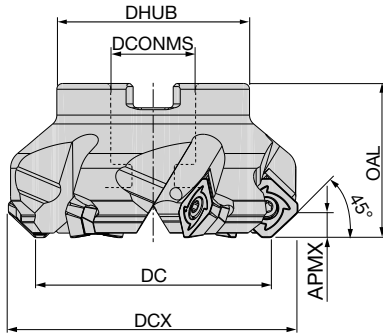

Aufsteckfräser 45° / SE.. 13 Face milling cutter 45° / SE.. 13



Abmessungen [mm] Dimensions [mm]							Artikelbezeichnung Item code	Bestell-Nr. Ordering No.	Verfügbarkeit Availability	Ersatzteile Spare parts		
DC	DCX	DCONMS	DHUB	OAL	APMX	ZEFF				Spann- schraube Fixation screw AP02-35121 $M_A = 5\text{Nm}$	Torx- Schlüssel Torque wrench IP15 5088520	 Schraube SE13 Screw 5171188 Unterlegsplatte SE13 Shim 5171189
50	63	22	44	40	6	4	BF45 SE13.050 Z04	5131670	○			
50	63	22	44	40	6	5	BF45 SE13.050 Z05	5131681	○			
63	76	22	50	40	6	5	BF45 SE13.063 Z05	5131672	○			
63	76	22	50	40	6	6	BF45 SE13.063 Z06	5131682	○			
80	93	27	60	50	6	6	BF45 SE13.080 Z06	5131673	○			
80	93	27	60	50	6	8	BF45 SE13.080 Z08	5131683	○			
100	113	32	80	50	6	7	BF45 SE13.100 Z07	5131674	○			
100	113	32	80	50	6	10	BF45 SE13.100 Z10	5131685	○			
125	138	40	95	63	6	8	BF45 SE13.125 Z08	5131675	○			
125	138	40	95	63	6	12	BF45 SE13.125 Z12	5131686	○			
160	173	40	115	63	6	7	BF45 SE13.160 Z07	5131687	○			
160	173	40	115	63	6	10	BF45 SE13.160 Z10	5131677	○			
200	213	60	164	63	6	8	BF45 SE13.200 Z08	5131688	○			
200	213	60	164	63	6	12	BF45 SE13.200 Z12	5131678	○			
250	263	60	184	63	6	10	BF45 SE13.250 Z10	5131689	○			
250	263	60	184	63	6	14	BF45 SE13.250 Z14	5131679	○			
315	334	60	265	80	6	12	BF45 SE13.315 Z12	5131691	○			
315	334	60	265	80	6	18	BF45 SE13.315 Z18	5131680	○			

Bestellbeispiel Order Example: 1 Stück piece 5131670 oder or BF45 SE13.050 Z04

CEDC = Anzahl der Schneidkanten CEDC = Number of cutting edges	Artikelbezeichnung Item code	Schneidstoffsorte Cutting materials	Bestell-Nr. Ordering No.	Verfügbarkeit Availability	Abmessungen [mm] Dimensions [mm]			
					IC	L	S	D1
	SEKT 13T3 AFSN-MP	BCP20M	5126205	●	13,4	13,4	3,97	4,2
	SEKT 13T3 AFSN-MP	BCP25M	5126203	●	13,4	13,4	3,97	4,2
	SEKT 13T3 AFSN-MP	BCP30M	5126200	○	13,4	13,4	3,97	4,2
	SEKT 13T3 AFSN-MP	BCP35M	5126199	●	13,4	13,4	3,97	4,2
	SEKT 13T3 AFEN-MM	BCM35M	5126212	●	13,4	13,4	3,97	4,2
	SEKT 13T3 AFEN-MM	BCM40M	5126210	●	13,4	13,4	3,97	4,2
	SEHT 13T3 AZFN-MN	BCN10M	5126228	●	13,4	13,4	3,97	4,2
	SEHT 13T3 AZFN-MN	BWN10M	5126227	●	13,4	13,4	3,97	4,2
CEDC = 4								
	SEKW 13T3 AFSN-MP	BCP25M	5126221	●	13,4	13,4	3,97	4,2
	SEKW 13T3 AFSN-MP	BCP30M	5126217	●	13,4	13,4	3,97	4,2
	SEKW 13T3 AFSN-MP	BCP35M	5126214	●	13,4	13,4	3,97	4,2
	SEKW 13T3 AFSN-MP	BCP40M	5126213	●	13,4	13,4	3,97	4,2
	SEKW 13T3 AFEN-MM	BCM40M	5126220	●	13,4	13,4	3,97	4,2
	SEKW 13T3 AFSN-MK	BCK15M	5126223	●	13,4	13,4	3,97	4,2
	SEKW 13T3 AFSN-MK	BCK20M	5126222	●	13,4	13,4	3,97	4,2
CEDC = 4								

	Aufsteckfräser 45° Face milling cutter 45°	Schafffräser 45° End milling cutter 45°	Einschraubfräser 45° Screw on type 45°
Ausführung Execution			
Durchmesserbereich metrisch Diameter range metric	Ø 50 - 200 mm	Ø 25 - 40 mm	Ø 25 - 40 mm
Durchmesserbereich inch Diameter range inch	Ø 2" - 8"	-	-
Plattengröße Insert size	XE..04, RE..13	XE..04, RE..13	XE..04, RE..13

Besondere Merkmale:

- Multifunktionales Werkzeugsystem für höchste Produktivität
- 1 Grundkörper für 2 Bearbeitungsverfahren = Multifunktional
- Einsparung von Trägerwerkzeugen durch multifunktionales Werkzeugsystem
- Positive Grundgeometrie dadurch leicht schneidend
- 7 Schneidkanten zur Produktivitätssteigerung beim Planfräsen
- 7 Schneidkanten bei der Rundplatte durch definierte geometrische Ausführung
- Markierung der Schneiden für exakten Rundlauf
- Durch die geringe Leistungsaufnahme, hohes Zerspanvolumen, auch auf leistungsschwachen alten Maschinen
- Ungleichteilung führt zu Schwingungsreduktion und extremer Laufruhe
- Schneidstoffvielfalt für optimale Zerspanungsergebnisse auf einem breiten Materialspektrum

Special features:

- Multifunctional tool system for highest productivity
- 1 basic body for 2 machining processes = multifunctional
- Saving of tool holders due to multifunctional tool system
- Positive basic geometry, therefore easy cutting
- 7 cutting edges for increase of productivity on face milling
- Round insert with 7 cutting edges through defined geometrical design
- Marking of the cutting edges for exact concentricity
- High metal removal also on inefficient old machines due to small power consumption
- Uneven spacing leads to reduced vibration and extremely smooth running
- Diversity of cutting materials for optimal cutting results on a wide material range

Eintauchwinkel
Ramping angle



WSP Geometrie Insert geometry	XEM. 04		REM. 13	
	Schnitttiefe* Cutting depth* [mm] APMX max	Vorschub* Feed* [mm] f _z	Schnitttiefe* Cutting depth* [mm] APMX max	Vorschub* Feed* [mm] f _z
MP	1,0 2,5 4,0	0,1 0,2 0,3	1,0 1,5 3,2	0,2 0,5 0,9
MM	1,0 2,5 4,0	0,1 0,2 0,3	1,0 1,5 3,2	0,2 0,4 0,8
MK	1,0 2,5 4,0	0,1 0,2 0,3	1,0 1,5 3,2	0,3 0,6 1,0
MN	1,0 3,0 4,0	0,1 0,2 0,3	---	---
MT	1,0 2,0 3,0	0,1 0,15 0,2	---	---
MH	0,6 1,0 2,0	0,1 0,2 0,3	0,5 1,0 3,0	0,2 0,4 0,7

Durchmesser Fräser Diameter milling cutter	Eintauchwinkel Fräser α max. Ramping angle milling cutter α max.
Ø 25	6,84°
Ø 32	5,36°
Ø 36	4,76°
Ø 40	4,29°
Ø 50	3,43°
Ø 52	3,30°
Ø 63	2,73°
Ø 66	2,60°
Ø 80	2,15°
Ø 100	1,72°
Ø 125	1,37°
Ø 160	1,07°
Ø 200	0,86°

Schnittwertempfehlungen siehe Seite 76

Cutting data recommendations page 76

* Angegebene Schnittdaten sind als Richtwert zu sehen, welche durch Versuche für jeden Anwendungsfall separat optimiert werden können.

* Recommended cutting data has to be seen as a reference which can be optimised for each application through trials separately.

Aufsteckfräser 45° / XE.. 04 & RE.. 13
Face milling cutter 45° / XE.. 04 & RE.. 13

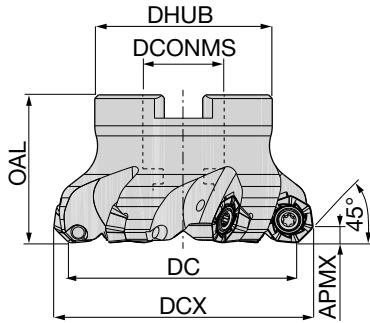

Abmessungen [mm] Dimensions [mm]							Artikelbezeichnung Item code	Bestell-Nr. Ordering No.	Verfügbarkeit Availability	Ersatzteile Spare parts	
DC	DCX	DCONMS	DHUB	OAL	APMX	ZEFF [♣]					
50	57,5	22	43	40	4	5	BF45 XE04.050 Z05	5103595	●	 Torx-Schlüssel Torque wrench IP15 5088520	
52	59,5	22	43	40	4	5	BF45 XE04.052 Z05	5103596	●		
63	70,5	22	48	40	4	5	BF45 XE04.063 Z05	5103598	●		
63	70,5	22	48	40	4	6	BF45 XE04.063 Z06	5103599	●		
66	73,5	22	48	40	4	6	BF45 XE04.066 Z06	5103601	●		
80	87,5	27	60	50	4	6	BF45 XE04.080 Z06	5103602	●		
80	87,5	27	60	50	4	8	BF45 XE04.080 Z08	5103603	●		
100	107,5	32	78	50	4	8	BF45 XE04.100 Z08	5103606	●		
100	107,5	32	78	50	4	10	BF45 XE04.100 Z10	5103607	●		
125	132,5	40	90	60	4	10	BF45 XE04.125 Z10	5103608	●		
125	132,5	40	90	60	4	12	BF45 XE04.125 Z12	5103609	●		
160	167,5	40	115	65	4	10	BF45 XE04.160 Z10 NC	5103610	●		
160	167,5	40	115	65	4	14	BF45 XE04.160 Z14 NC	5103611	●		
200	207,5	60	140	65	4	16	BF45 XE04.200 Z16 NC	5103612	●		

Aufsteckfräser 45° / XE.. 04 & RE.. 13 / INCH
Face milling cutter 45° / XE.. 04 & RE.. 13 / INCH

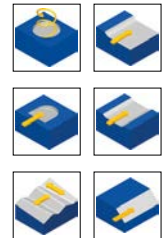
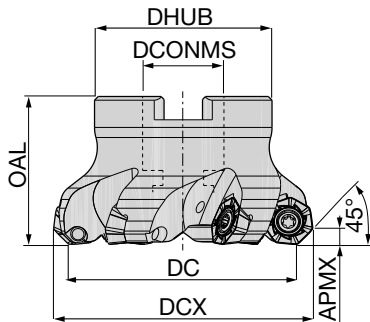

Abmessungen [INCH] Dimensions [INCH]							Artikelbezeichnung Item code	Bestell-Nr. Ordering No.	Verfügbarkeit Availability	Ersatzteile Spare parts	
DC	DCX	DCONMS	DHUB	OAL	APMX	ZEFF [♣]					
2.0	2.3	0.75	1.75	1.75	0.157	5	BFU45 XE04.2000 Z05	5132856	○	 Torx-Schlüssel Torque wrench IP15 5088520	
2.5	2.8	1.00	2.00	1.75	0.157	5	BFU45 XE04.2500 Z05	5132857	○		
2.5	2.8	1.00	2.00	1.75	0.157	6	BFU45 XE04.2500 Z06	5132858	○		
3.0	3.3	1.25	2.75	2.00	0.157	6	BFU45 XE04.3000 Z06	5132859	○		
3.0	3.3	1.25	2.75	2.00	0.157	8	BFU45 XE04.3000 Z08	5132860	○		
4.0	4.3	1.50	3.50	2.00	0.157	8	BFU45 XE04.4000 Z08	5132861	○		
4.0	4.3	1.50	3.50	2.00	0.157	10	BFU45 XE04.4000 Z10	5132862	○		
5.0	5.3	1.50	3.75	2.50	0.157	10	BFU45 XE04.5000 Z10	5132863	○		
5.0	5.3	1.50	3.75	2.50	0.157	12	BFU45 XE04.5000 Z12	5132864	○		
6.0	6.3	2.00	5.00	2.50	0.157	10	BFU45 XE04.6000 Z10 NC	5132865	○		
6.0	6.3	2.00	5.00	2.50	0.157	14	BFU45 XE04.6000 Z14 NC	5132866	○		
8.0	8.3	2.50	6.00	2.50	0.157	16	BFU45 XE04.8000 Z16 NC	5132867	○		

Bestellbeispiel Order example: 1 Stück piece 5103595 oder or BF45 XE04.050 Z05
 NC = Keine Kühlung / no coolant

● Verfügbar ab Lager Available from stock
 ○ Lieferzeit auf Anfrage Delivery time on request



ETatec 45P

Multifunktional Multifunctional

www.boehlerit.com

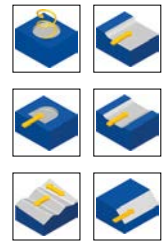
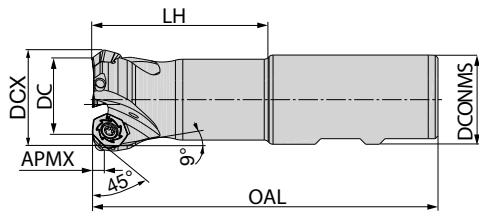

Schafffräser 45° / XE.. 04 & RE.. 13 End milling cutter 45° / XE.. 04 & RE.. 13

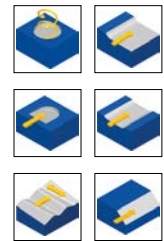
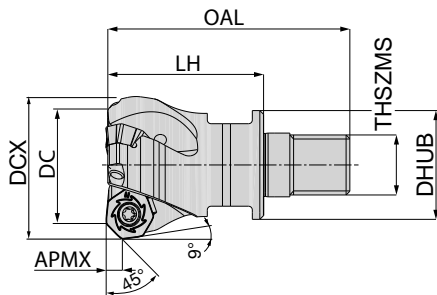

Abmessungen [mm] Dimensions [mm]							Schaft Shank	Artikelbezeichnung Item code	Bestell-Nr. Ordering No.	Verfügbarkeit Availability	Ersatzteile Spare parts	
DC	DCX	DCONMS	LH	OAL	APMX	ZEFF [⊙]						
25	32,5	25	50	106	4	2	HB	BE45 XE04.025 Z02	5103614	●	 Spanschraube Fixation screw AP02-40082 5122796 M _A = 3Nm	 Torx- Schlüssel Torque wrench IP15 5088520
32	39,5	32	64	124	4	3	HB	BE45 XE04.032 Z03	5103616	●		
36	43,5	32	64	124	4	3	HB	BE45 XE04.036 Z03	5103623	●	Spanschraube Fixation screw AP02-40054 5085714 M _A = 3Nm	Torx- Schlüssel Torque wrench IP15 5088520
40	47,5	32	65	130	4	4	HB	BE45 XE04.040 Z04	5103617	●		

Einschraubfräser 45° / XE.. 04 & RE.. 13 Screw on type 45° / XE.. 04 & RE.. 13



Abmessungen [mm] Dimensions [mm]							Artikelbezeichnung Item code	Bestell-Nr. Ordering No.	Verfügbarkeit Availability	Ersatzteile Spare parts		
DC	DCX	DHUB	LH	OAL	THSZMS	APMX				ZEFF [⊙]		
25	32,5	21	32	54	M12	4	2	BS45 XE04.025 Z02 M12	5103620	●	 Spanschraube Fixation screw AP02-40082 5122796 M _A = 3Nm	 Torx- Schlüssel Torque wrench IP15 5088520
32	39,5	29	42	65	M16	4	3	BS45 XE04.032 Z03 M16	5103621	●		
40	47,5	29	43	66	M16	4	4	BS45 XE04.040 Z04 M16	5103628	●	Spanschraube Fixationscrew AP02-40054 5085714 M _A = 3Nm	Torx- Schlüssel Torque wrench IP15 5088520

Bestellbeispiel Order example: 1 Stück piece 5103614 oder or BE45 XE04.025 Z02

Die passenden Hartmetallverlängerungen finden Sie ab Seite 294

You will find the matching carbide extensions from page 294

CEDC = Anzahl der Schneidkanten CEDC = Number of cutting edges	Artikelbezeichnung Item code	Schneidstoffsorte Cutting materials	Bestell-Nr. Ordering No.	Verfügbarkeit Availability	Abmessungen [mm] Dimensions [mm]					
					L	IC	S	D1	RE	
	XEMT 040408-MP	BCP20M	5103790	●	4	12,7	4,76	4,6	0,8	
	XEMT 040408-MP	BCP25M	5103792	●	4	12,7	4,76	4,6	0,8	
	XEMT 040408-MP	BCP30M	5103789	●	4	12,7	4,76	4,6	0,8	
	XEMT 040408-MP	BCP35M	5103788	●	4	12,7	4,76	4,6	0,8	
	XEMT 040408-MM	BCM35M	5103797	●	4	12,7	4,76	4,6	0,8	
	XEMT 040408-MM	BCM40M	5103799	●	4	12,7	4,76	4,6	0,8	
	XEHT 040408-MN	BWN10M	5141453	●	4	12,7	4,76	4,6	0,8	
	XEHT 040408-MN	BCN10M	5141454	●	4	12,7	4,76	4,6	0,8	
	XEGT 040408-MT	BCS35M	5120324	●	4	12,7	4,76	4,6	0,8	
		XEMW 040408-MP	BCP25M	5103815	●	4	12,7	4,76	4,6	0,8
		XEMW 040408-MP	BCP30M	5103813	●	4	12,7	4,76	4,6	0,8
		XEMW 040408-MP	BCP35M	5103811	●	4	12,7	4,76	4,6	0,8
		XEMW 040408-MP	BCP40M	5103814	●	4	12,7	4,76	4,6	0,8
		XEMW 040408-MM	BCM40M	5103903	●	4	12,7	4,76	4,6	0,8
		XEMW 040408-MK	BCK20M	5103816	●	4	12,7	4,76	4,6	0,8
		XEMW 040408-MH	BCH05M	5117576	●	4	12,7	4,76	4,6	0,8
		XEMW 040408-MH	BCH10M	5117579	●	4	12,7	4,76	4,6	0,8

CEDC = 7

Ausführung Execution	Aufsteckfräser 45° Face milling cutter 45°
	
Durchmesserbereich metrisch Diameter range metric	Ø 50 - 250 mm
Durchmesserbereich inch Diameter range inch	Ø 2" - 10"
Plattengröße Insert size	SN.. 12

Besondere Merkmale:

- 8 Schneidkanten zur Produktivitätssteigerung bei hohen Schnitttiefen
- Negative Grundgeometrie dadurch extrem stabil
- Effektiv positive Schneidkantengeometrie, dadurch leichter Schnitt
- Markierung der Schneiden für exakten Rundlauf
- WIPER - Geometrie (Breitschlichtplatte) für qualitativ hochwertige Oberfläche
- Hohes Zerspanvolumen, durch enge und sehr enge Teilung der Werkzeuge
- Ungleichteilung führt zu Schwingungsreduktion und zu extremer Laufruhe
- Schneidstoffvielfalt für optimale Zerspanungsergebnisse auf einem breiten Materialspektrum

Special features:

- 8 cutting edges for increase of productivity at big cutting depths
- Negative basic geometry, therefore extremely stable
- Effective positive cutting edge geometry, therefore smooth cut
- Marking of the cutting edges for exact concentricity
- WIPER geometry for qualitativ high-class surface
- High metal removal, due to narrow and very narrow division of the tools
- Uneven spacing leads to reduced vibration and extremely smooth running
- Diversity of cutting materials for optimal cutting results on a wide material range

WSP Geometrie Insert geometry	SN.. 12	
	Schnitttiefe* Cutting depth* [mm] APMX max	Vorschub* Feed* [mm] f _z
MP	1,0 4,0 6,5	0,2 0,3 0,4
MM	1,0 4,0 6,5	0,15 0,2 0,3
MK	1,0 4,0 6,5	0,2 0,3 0,4
MN	0,7 4,0 6,5	0,15 0,22 0,35
MS	1,0 4,0 6,5	0,15 0,2 0,3
FW	0,2 0,5 0,7	0,2 0,3 0,4

Schnittwertempfehlungen siehe Seite 76

Cutting data recommendations page 76

* Angegebene Schnittdaten sind als Richtwert zu sehen, welche durch Versuche für jeden Anwendungsfall separat optimiert werden können.

* Recommended cutting data has to be seen as a reference which can be optimised for each application through trials separately.

Aufsteckfräser 45° / SN.. 12
Face milling cutter 45° / SN.. 12

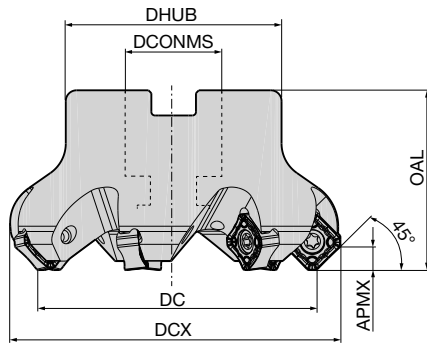



Abmessungen [mm] Dimensions [mm]							Artikelbezeichnung Item code	Bestell-Nr. Ordering No.	Verfügbarkeit Availability	Ersatzteile Spare parts	
DC	DCX	DCONMS	DHUB	OAL	APMX	ZEFF [☆]					
50	63,4	22	50	40	6,5	4	BF45 SN12.050 Z04	5079179	●		
50	63,4	22	50	40	6,5	6	BF45 SN12.050 Z06	5079186	●		
63	76,4	22	50	40	6,5	5	BF45 SN12.063 Z05	5131664	○		
63	76,4	22	50	40	6,5	6	BF45 SN12.063 Z06	5079187	●		
63	76,4	22	50	40	6,5	8	BF45 SN12.063 Z08	5079188	●		
80	93,4	27	60	50	6,5	6	BF45 SN12.080 Z06	5103109	●		
80	93,4	27	60	50	6,5	7	BF45 SN12.080 Z07	5079189	●		
80	93,4	27	60	50	6,5	10	BF45 SN12.080 Z10	5079190	●		
100	113,4	32	80	50	6,5	8	BF45 SN12.100 Z08	5079191	●		
100	113,4	32	80	50	6,5	12	BF45 SN12.100 Z12	5079192	●		
125	138,4	40	95	63	6,5	8	BF45 SN12.125 Z08	5131666	○		
125	138,4	40	95	63	6,5	10	BF45 SN12.125 Z10	5079193	●		
125	138,4	40	95	63	6,5	16	BF45 SN12.125 Z16	5079194	●		
160	173,4	40	115	63	6,5	10	BF45 SN12.160 Z10 NC	5131667	○		
160	173,4	40	115	63	6,5	12	BF45 SN12.160 Z12	5091855	○		
160	173,4	40	115	63	6,5	12	BF45 SN12.160 Z12 NC	5079195	●		
160	173,4	40	115	63	6,5	20	BF45 SN12.160 Z20 NC	5085863	○		
200	213,4	60	164	63	6,5	18	BF45 SN12.200 Z18 NC	5079196	●		
200	213,4	60	164	63	6,5	26	BF45 SN12.200 Z26 NC	5085873	○		
250	263,4	60	184	63	6,5	20	BF45 SN12.250 Z20 NC	5079197	●		
250	263,4	60	184	63	6,5	30	BF45 SN12.250 Z30 NC	5085874	○		

NC = Keine Kühlung / no coolant

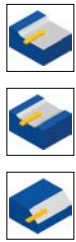
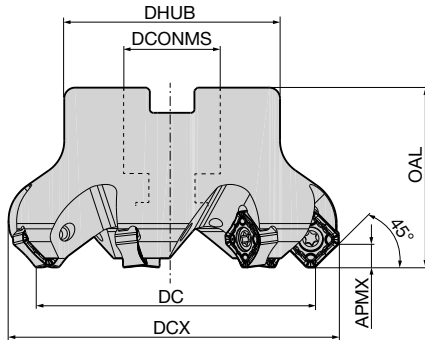

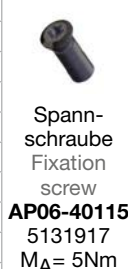

Aufsteckfräser 45° / SN.. 12 / INCH
Face milling cutter 45° / SN.. 12 / INCH

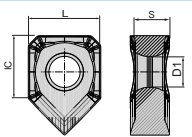

Abmessungen [INCH] Dimensions [INCH]							Artikelbezeichnung Item code	Bestell-Nr. Ordering No.	Verfügbarkeit Availability	Ersatzteile Spare parts			
DC	DCX	DCONMS	DHUB	OAL	APMX	ZEFF [⊙]				 Spannschraube Fixation screw AP06-40115 5131917 M _A = 5Nm	 Torx-Schlüssel Torque wrench IP20 5088521		
2.0	2.5	0.75	2.00	1.50	0.256	4	BFU45 SN12.2000 Z04	5132797	○				
2.0	2.5	0.75	2.00	1.50	0.256	6	BFU45 SN12.2000 Z06	5132798	○				
2.5	3.0	1.00	2.50	1.75	0.256	6	BFU45 SN12.2500 Z06	5132799	○				
2.5	3.0	1.00	2.50	1.75	0.256	8	BFU45 SN12.2500 Z08	5132800	○				
3.0	3.5	1.00	2.50	1.75	0.256	7	BFU45 SN12.3000 Z07	5132802	○				
3.0	3.5	1.00	2.50	1.75	0.256	10	BFU45 SN12.3000 Z10	5132803	○				
4.0	4.5	1.50	3.75	2.25	0.256	8	BFU45 SN12.4000 Z08	5132804	○				
4.0	4.5	1.50	3.75	2.25	0.256	12	BFU45 SN12.4000 Z12	5132805	○				
5.0	5.5	1.50	3.75	2.50	0.256	10	BFU45 SN12.5000 Z10	5132806	○				
5.0	5.5	1.50	3.75	2.50	0.256	16	BFU45 SN12.5000 Z16	5132808	○				
6.0	6.5	2.00	5.00	2.50	0.256	12	BFU45 SN12.6000 Z12 NC	5132809	○				
6.0	6.5	2.00	5.00	2.50	0.256	20	BFU45 SN12.6000 Z20 NC	5132811	○				
8.0	8.5	2.50	6.00	2.50	0.256	18	BFU45 SN12.8000 Z18 NC	5132812	○				
10	10.5	2.50	7.50	2.50	0.256	20	BFU45 SN12.10000 Z20 NC	5132814	○				

Bestellbeispiel Order example: 1 Stück piece 5132797 oder or BFU45 SN12.2000 Z04

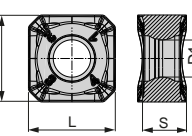
NC = Keine Kühlung / no coolant

CEDC = Anzahl der Schneidkanten CEDC = Number of cutting edges	Artikelbezeichnung Item code	Schneidstoffsorte Cutting materials	Bestell-Nr. Ordering No.	Verfügbarkeit Availability	Abmessungen [mm] Dimensions [mm]				
					L	IC	S	D1	RE
  CEDC = 2	SNEX 1206-FW*	BCM35M	5090743	●	12,70	12,70	5,8	5,2	-
  CEDC = 8	SNMX 1206 ANSN-MP	BCP20M	5092061	●	12,70	12,70	5,8	5,2	-
	SNMX 1206 ANSN-MP	BCP25M	5081869	●	12,70	12,70	5,8	5,2	-
	SNMX 1206 ANSN-MP	BCP30M	5081870	●	12,70	12,70	5,8	5,2	-
	SNMX 1206 ANSN-MP	BCP35M	5081011	●	12,70	12,70	5,8	5,2	-
	SNMX 1206 ANSN-MM	BCM35M	5090093	●	12,70	12,70	6,2	5,2	-
	SNMX 1206 ANSN-MM	BCM40M	5081872	●	12,70	12,70	6,2	5,2	-
	SNMX 1206 ANSN-MK	BCK15M	5081013	●	12,70	12,70	5,8	5,2	-
	SNMX 1206 ANSN-MK	BCK20M	5081012	●	12,70	12,70	5,8	5,2	-
	SNHX 1206 ANFN-MN	BCN10M	5141461	●	12,7	12,7	6,2	5,2	-
	SNHX 1206 ANFN-MN	BWN10M	5141458	●	12,7	12,7	6,2	5,2	-
SNMX 1206 ANSN-MS	BCS35M	5162141	●	12,70	12,70	6,2	5,2	-	
SNMX 1206 ANSN-MS	BCS40M	5168101	●	12,70	12,70	6,2	5,2	-	

Bestellbeispiel Order example: 10 Stück pieces 5090743 oder or SNEX 1206-FW BCM35M

● Verfügbar ab Lager Available from stock

○ Lieferzeit auf Anfrage Delivery time on request

*Breitschichtplatte SNEX 1206-FW nur kompatibel mit P- und K-Sorten Wiper insert SNEX 1206-FW only usable together with P- and K- grades

Aufsteckfräser 45° Face milling cutter 45°	
Ausführung Execution	
Durchmesserbereich metrisch Diameter range metric	Ø 50 - 250 mm
Durchmesserbereich inch Diameter range inch	Ø 2" - 10"
Plattengröße Insert size	ON.. 05, ON.. 08

Besondere Merkmale:

- 16 Schneidkanten zur Produktivitätssteigerung
- Negative Grundgeometrie, dadurch extrem stabil
- Effektiv positive Schneidkantenengeometrie, dadurch leichter Schnitt
- Nummerierung der Schneiden für exakten Rundlauf
- WIPER (Breitschlichtplatte) - Geometrie für qualitativ hochwertige Oberfläche.
Beste Ergebnisse bei Erhöhung der Schnittwertempfehlung (ca. doppelte v_c , niedriger Schnitttiefe, ca. a_p 0,7 mm Zahnvorschub, ca. f_z 0,25 mm bei Fräserdurchmesser 63 mm)
- Hohes Zerspanvolumen durch enge Teilung der Werkzeuge
- Ungleichteilung führt zu Schwingungsreduktion und extremer Laufruhe
- Schneidstoffvielfalt für optimale Zerspanungsergebnisse auf einem breiten Materialspektrum

Special features:

- 16 cutting edges for increase of productivity
- Negative basic geometry, thus extremely stable
- Effective positive cutting edge geometry, thus smooth cut
- Numbering of cutting edges for exact true running
- WIPER – geometry for qualitativ high-class surface. Best results if increasing cutting speed (approximately double v_c , small cutting depth, approximately a_p 0.7 mm, tooth feed approximately f_z 0.25 mm with milling cutter diameter 63 mm)
- High metal removal due to close division of the tools
- Uneven spacing leads to reduced vibration and extremely smooth running
- Cutting material diversity for optimal cutting results on a wide material range

WSP Geometrie Insert geometry	ON.. 05		ON.. 08	
	Schnitttiefe* Cutting depth* [mm] APMX max	Vorschub* Feed* [mm] f_z	Schnitttiefe* Cutting depth* [mm] APMX max	Vorschub* Feed* [mm] f_z
MP	0,4 2,0 3,0	0,16 0,22 0,30	1,0 3,0 5,0	0,2 0,27 0,5
MM	0,4 2,0 3,0	0,12 0,18 0,25	1,0 3,0 5,0	0,2 0,25 0,4
MK	0,4 2,0 3,0	0,20 0,25 0,35	1,0 3,0 5,0	0,2 0,35 0,6
MH	0,4 1,5 2,5	0,10 0,16 0,26	-	-
FW	0,3 0,5 0,7	0,17 0,22 0,25	0,5 0,7 0,9	0,2 0,25 0,3

Schnittwertempfehlungen siehe Seite 76
Cutting data recommendations page 76

* Angegebene Schnittdaten sind als Richtwert zu sehen, welche durch Versuche für jeden Anwendungsfall separat optimiert werden können.
* Recommended cutting data has to be seen as a reference which can be optimised for each application through trials separately.

Pltec 45N

Systemgröße 05 System size 05

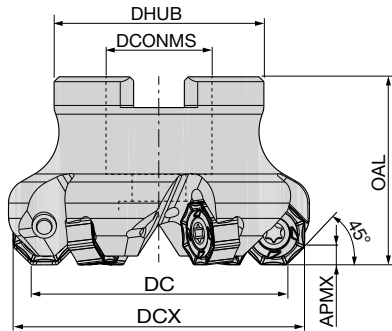

www.boehlerit.com

Aufsteckfräser 45° / ON.. 05 Face milling cutter 45° / ON.. 05



Kompatibel mit
ONMU 05 & SNMX 12
Wendeschneidplatten
Compatible with
ONMU 05 & SNMX 12
indexable inserts



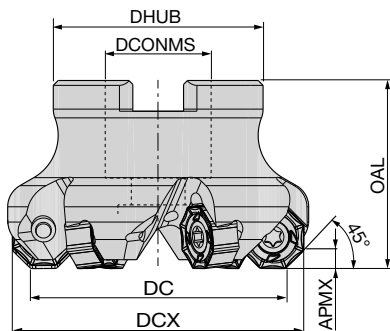

Abmessungen [mm] Dimensions [mm]							Artikelbezeichnung Item code	Bestell-Nr. Ordering No.	Verfügbarkeit Availability	Ersatzteile Spare parts	
DC	DCX	DCONMS	DHUB	OAL	APMX	ZEFF \odot					
50	57,5	22	50	40	3	4	BF45 ON05.050 Z04	5125749	●	 Spannschraube Fixation screw AP06-40115 5131917 M _A = 5Nm	 Torx-Schlüssel Torque wrench IP20 5088521
50	57,5	22	50	40	3	6	BF45 ON05.050 Z06	5125750	●		
63	70,5	22	50	40	3	6	BF45 ON05.063 Z06	5125751	●		
63	70,5	22	50	40	3	8	BF45 ON05.063 Z08	5125752	●		
80	87,5	27	60	50	3	7	BF45 ON05.080 Z07	5125753	●		
80	87,5	27	60	50	3	10	BF45 ON05.080 Z10	5125754	●		
100	107,5	32	80	50	3	8	BF45 ON05.100 Z08	5125755	●		
100	107,5	32	80	50	3	12	BF45 ON05.100 Z12	5125756	●		
125	132,5	40	95	63	3	10	BF45 ON05.125 Z10	5125757	●		
125	132,5	40	95	63	3	16	BF45 ON05.125 Z16	5125758	●		

Aufsteckfräser 45° / ON.. 05 / INCH Face milling cutter 45° / ON.. 05 / INCH



Kompatibel mit
ONMU 05 & SNMX 12
Wendeschneidplatten
Compatible with
ONMU 05 & SNMX 12
indexable inserts



Abmessungen [INCH] Dimensions [INCH]							Artikelbezeichnung Item code	Bestell-Nr. Ordering No.	Verfügbarkeit Availability	Ersatzteile Spare parts	
DC	DCX	DCONMS	DHUB	OAL	APMX	ZEFF \odot					
2.1	2.4	0.75	2.00	1.45	0.118	4	BFU45 SN12.2000 Z04	5132797	○	 Spannschraube Fixation screw AP06-40115 5131917 M _A = 5Nm	 Torx-Schlüssel Torque wrench IP20 5088521
2.1	2.4	0.75	2.00	1.45	0.118	6	BFU45 SN12.2000 Z06	5132798	○		
2.6	2.9	1.00	2.50	1.70	0.118	6	BFU45 SN12.2500 Z06	5132799	○		
2.6	2.9	1.00	2.50	1.70	0.118	8	BFU45 SN12.2500 Z08	5132800	○		
3.1	3.4	1.00	2.50	1.70	0.118	7	BFU45 SN12.3000 Z07	5132802	○		
3.1	3.4	1.00	2.50	1.70	0.118	10	BFU45 SN12.3000 Z10	5132803	○		
4.1	4.4	1.50	3.75	2.20	0.118	8	BFU45 SN12.4000 Z08	5132804	○		
4.1	4.4	1.50	3.75	2.20	0.118	12	BFU45 SN12.4000 Z12	5132805	○		
5.1	5.4	1.50	3.75	2.45	0.118	10	BFU45 SN12.5000 Z10	5132806	○		
5.1	5.4	1.50	3.75	2.45	0.118	16	BFU45 SN12.5000 Z16	5132808	○		
6.1	6.4	2.00	5.00	2.45	0.118	12	BFU45 SN12.6000 Z12 NC	5132809	○		
6.1	6.4	2.00	5.00	2.45	0.118	20	BFU45 SN12.6000 Z20 NC	5132811	○		
8.1	8.4	2.50	6.00	2.45	0.118	18	BFU45 SN12.8000 Z18 NC	5132812	○		
10.1	10.4	2.50	7.50	2.45	0.118	20	BFU45 SN12.10000 Z20 NC	5132814	○		

Bestellbeispiel Order example: 1 Stück piece 5125749 oder or BF45 ON05.050 Z04

NC = Keine Kühlung / no coolant

CEDC = Anzahl der Schneidkanten CEDC = Number of cutting edges	Artikelbezeichnung Item code	Schneidstoffsorte Cutting materials	Bestell-Nr. Ordering No.	Verfügbarkeit Availability	Abmessungen [mm] Dimensions [mm]				
					L	IC	S	D1	RE
<p>CEDC = 8</p>	ONMQ 0506-FW	BCH10M	5125076	●	5	12,7	5,8	5,45	0,8
<p>CEDC = 16</p>	ONMU 050608 SN-MP	BCH10M	5124908	●	5	12,7	5,8	5,45	0,8
	ONMU 050608 SN-MP	BCP25M	5124904	●	5	12,7	5,8	5,45	0,8
	ONMU 050608 SN-MP	BCP35M	5124905	●	5	12,7	5,8	5,45	0,8
	ONMU 050608 SN-MM	BCM35M	5124906	●	5	12,7	5,8	5,45	0,8
	ONMU 050608 SN-MM	BCM40M	5124907	●	5	12,7	5,8	5,45	0,8
	ONMU 050608 SN-MK	BCK15M	5146195	●	5	12,7	5,8	5,45	0,8
	ONMU 050608 SN-MK	BCK20M	5124909	●	5	12,7	5,8	5,45	0,8
	ONMU 050608 SN-MH	BCH05M	5146193	●	5	12,7	5,8	5,45	0,8
	ONMU 050608 SN-MH	BCH10M	5124908	●	5	12,7	5,8	5,45	0,8

Wendeschneidplatte SNMX siehe Seite 64 / indexable inserts SNMX see page 64

Aufsteckfräser 45° / ON.. 08
Face milling cutter 45° / ON.. 08

Abmessungen [mm] Dimensions [mm]							Artikelbezeichnung Item code	Bestell-Nr. Ordering No.	Verfügbarkeit Availability	Ersatzteile Spare parts	
DC	DCX	DCONMS	DHUB	OAL	APMX	ZEFF				Spannschraube Fixation screw A02-60160 6401270 M _A = 6Nm	Torx-Schlüssel Torque wrench T25 5088518
50	62	22	46	50	5	4	BF45 ON08.050 Z04	5081735	●		
63	75	27	58	50	5	5	BF45 ON08.063 Z05	5081737	●		
80	92	32	78	50	5	6	BF45 ON08.080 Z06	5081741	●		
80	92	32	78	50	5	7	BF45 ON08.080 Z07	5081742	●		
100	112	32	78	50	5	7	BF45 ON08.100 Z07	5081743	●		
100	112	32	78	50	5	9	BF45 ON08.100 Z09	5081749	●		
125	137	40	90	63	5	9	BF45 ON08.125 Z09	5081752	●		
125	137	40	90	63	5	11	BF45 ON08.125 Z11	5081753	●		
160	172	40	115	65	5	11	BF45 ON08.160 Z11	5081756	●		
200	212	60	130	65	5	16	BF45 ON08.200 Z16 NC	5095604	●		
250	262	60	184	63	5	18	BF45 ON08.250 Z18 NC	5105349	●		
315	327	60	249	63	5	22	BF45 ON08.315 Z22 NC	5128646	○		

NC = Keine Kühlung / no coolant

- Verfügbar ab Lager Available from stock
- Lieferzeit auf Anfrage Delivery time on request

Bestellbeispiel Order example: 1 Stück piece 5081735 oder or BF45 ON08.050 Z04

Pltec 45N

Systemgröße 08 System size 08

www.boehlerit.com

Aufsteckfräser 45° / ON.. 08 / INCH Face milling cutter 45° / ON.. 08 / INCH

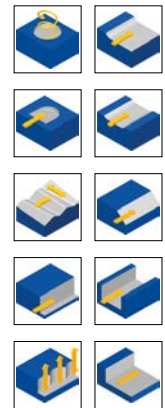
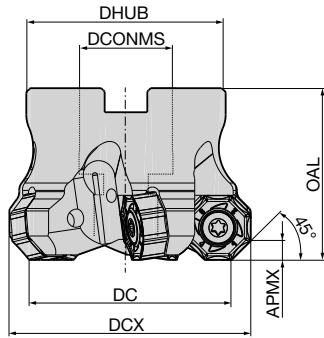

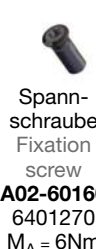
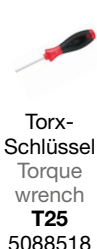
Abmessungen [INCH] Dimensions [INCH]							Artikelbezeichnung Item code	Bestell-Nr. Ordering No.	Verfügbarkeit Availability	Ersatzteile Spare parts	
DC	DCX	DCONMS	DHUB	OAL	APMX	ZEFF [☆]					
2.0	2.4	0.75	2.00	2.00	0.197	4	BFU45 ON08.2000 Z04	5132815	○	 Spannschraube Fixation screw A02-60160 6401270 M _A = 6Nm	 Torx- Schlüssel Torque wrench T25 5088518
2.5	2.9	1.00	2.25	2.00	0.197	5	BFU45 ON08.2500 Z05	5132816	○		
3.0	3.4	1.25	2.75	2.00	0.197	6	BFU45 ON08.3000 Z06	5132817	○		
3.0	3.4	1.25	2.75	2.00	0.197	7	BFU45 ON08.3000 Z07	5132818	○		
4.0	4.4	1.50	3.75	2.25	0.197	7	BFU45 ON08.4000 Z07	5132819	○		
4.0	4.4	1.50	3.75	2.25	0.197	9	BFU45 ON08.4000 Z09	5132820	○		
5.0	5.4	1.50	3.75	2.50	0.197	9	BFU45 ON08.5000 Z09	5132821	○		
5.0	5.4	1.50	3.75	2.50	0.197	11	BFU45 ON08.5000 Z11	5132822	○		
6.0	6.4	2.00	5.00	2.50	0.197	11	BFU45 ON08.6000 Z11	5132823	○		

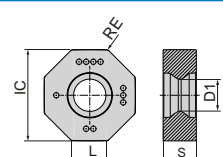
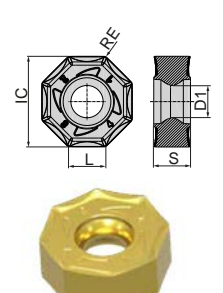
CEDC = Anzahl der Schneidkanten CEDC = Number of cutting edges	Artikelbezeichnung Item code	Schneidstoffsorte Cutting materials	Bestell-Nr. Ordering No.	Verfügbarkeit Availability	Abmessungen [mm] Dimensions [mm]				
					L	IC	S	D1	RE
 CEDC = 8	ONMQ 0806-FW	BCM35M	5092307	●	8	19,1	6,95	6,75	0,8
	ONMQ 0806-FW	BCH03M	5125075	○	8	19,1	6,95	6,75	0,8
	ONMQ 0806-FW	BCH10M	5125074	●	8	19,1	6,95	6,75	0,8
 CEDC = 16	ONMU 080608 SN-MP	BCP20M	5092103	●	8	19	6,95	6,75	0,8
	ONMU 080608 SN-MP	BCP25M	5081895	●	8	19	6,95	6,75	0,8
	ONMU 080608 SN-MP	BCP30M	5081885	●	8	19	6,95	6,75	0,8
	ONMU 080608 SN-MP	BCP35M	5081888	●	8	19	6,95	6,75	0,8
	ONMU 080608 SN-MM	BCM35M	5081958	●	8	19	6,95	6,75	0,8
	ONMU 080608 SN-MM	BCM40M	5081896	●	8	19	6,95	6,75	0,8
	ONMU 080608 SN-MK	BCK15M	5081894	●	8	19	6,95	6,75	0,8
	ONMU 080608 SN-MK	BCK20M	5081890	●	8	19	6,95	6,75	0,8

Bestellbeispiel Order example: 1 Stück piece 5132815 oder or BFU45 ON08.2000 Z04

NC = Keine Kühlung / no coolant

● Verfügbar ab Lager Available from stock

○ Lieferzeit auf Anfrage Delivery time on request

Ausführung Execution	Aufsteckfräser 55° Face milling cutter 55°
	
Durchmesserbereich metrisch Diameter range metric	Ø 80 - 315 mm
Plattengröße Insert size	PN.. 13

Besondere Merkmale:

- Stabiles negatives Planfrässystem für die Schruppbearbeitung
- 10 Schneidkanten pro Wendeschneidplatte
- Schnitttiefen bis APMX 9,5mm realisierbar, dadurch hohe Zerspanungsraten möglich
- Innovatives Spannsystem mittel Tellerschraube zur einfachen Handhabung beim Wendeschneidplattentausch, auch in der Maschine
- Schneidstoffvielfalt für optimale Zerspanungsergebnisse
- Unterlegsplatte zur Vibrationsreduktion und zum Schutz des Plattensitzes bei Plattenbruch

Special features:

- Stable designed negative face milling system for rough machining
- 10 cutting edges per insert
- Depth of cuts up to 9,5mm possible, therof high removal rates
- Easy handling on insert change, due to innovative clamping method, also withing machine
- Wide range of cutting grades for optimal cutting results
- Shim for vibrationsreduction and also for saving of seat pockets in case of chrash or breakages

WSP Geometrie Insert geometry	PN.. 13	
	Schnitttiefe Cutting depth [mm] a_p max	Vorschub Feed [mm] f_z
MP	2,0 4,0 8,5	0,2 0,4 0,6
RM	2,0 4,0 8,5	0,2 0,38 0,55
MK	2,0 4,0 9,5	0,3 0,5 0,7

Informationen zum Fräser:

Fräser einsatzfertig montiert - exklusive Wendeschneidplatte

Information about the milling cutter:

Milling cutter ready to use - exclusive Inserts

Planfräskopf 55° / PN.. 13
Face milling cutter 55° / PN.. 13

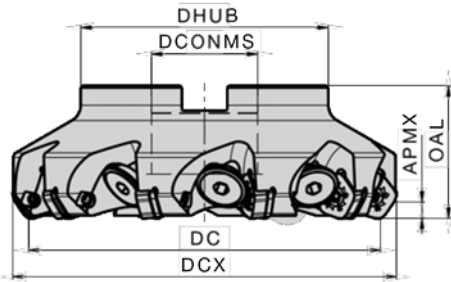

Abmessungen [mm] Dimensions [mm]							Artikelbezeichnung Item code	Bestell-Nr. Ordering No.	Verfügbarkeit Availability
DC	DCX	DCONMS	DHUB	OAL	APMX	ZEFF ϕ			
80	97,2	27	75	60	9,5	5	BF55 PN13.080 Z05 NC	5220299	○
100	117,2	32	100	60	9,5	5	BF55 PN13.100 Z05 NC	5219469	●
125	142,2	40	115	60	9,5	6	BF55 PN13.125 Z06 NC	5220309	●
160	177,2	40	115	70	9,5	8	BF55 PN13.160 Z08 NC	5209898	●
200	217,2	60	140	75	9,5	10	BF55 PN13.200 Z10 NC	5209899	●
250	267,2	60	190	75	9,5	12	BF55 PN13.250 Z12 NC	5220310	●
315	332,2	60	240	75	9,5	14	BF55 PN13.315 Z14 NC	5220312	○

Ersatzteile für Planfräskopf 55° PN.. 13
Spare parts for face milling cutter 55° PN.. 13

Spanschraube für Wendeschneidplatte Fräser DM 80-125 Clamping screw for indexable insert A02-80240 5222056	Spanschraube für Wendeschneidplatte Fräser DM 160-315 Clamping screw for indexable insert A02-120440 5222058	Spanschraube für die Unterlegsplatte Clamping screw for shim AP02-40086 5198554	Unterlegsplatte Shim 5083795

CEDC = Anzahl der Schneidkanten CEDC = Number of cutting edges	Artikelbezeichnung Item code	Schneidstoffsorte Cutting materials	Bestell-Nr. Ordering No.	Verfügbarkeit Availability	Abmessungen [mm] Dimensions [mm]				
					L	IC	S	D1	RE
CEDC = 10	PNMF 1307 ZNSR-MP	BCP35M	5220291	●	13	23,4	7,94	-	1
	PNMF 1307 ZNSR-MP	BCP40M	5220294	●	13	23,4	7,94	-	1
	PNMF 1307 ZNSR-RM	BCM40M	5220295	●	13	23,4	7,94	-	1
CEDC = 10	PNMN 1307 ZNSN-MK	BCK15M	5220297	●	13	23,4	7,94	-	1
	PNMN 1307 ZNSN-MK	BCK20M	5220298	●	13	23,4	7,94	-	1

Bestellbeispiel Order example: 10 Stück piece 5220299 oder or BF55 PN13.080 Z05 NC

- Verfügbar ab Lager Available from stock
- ⦿ Kurzfristig lieferbar Available at short notice
- Lieferzeit auf Anfrage Delivery time on request

Ausführung Execution	Aufsteckfräser 45° Face milling cutter 45°
	
Durchmesserbereich metrisch Diameter range metric	Ø 125 - 500 mm
Plattengröße Insert size	HP.. 12, SP.. 20, SP.. 27, TP.. 31

Besondere Merkmale:

- Flexibilität in der Schwerzerspannung
- Ein Grundkörper – viele Möglichkeiten
- Einfaches Austauschen der Kassetten zum Planfräsen
- 4 Kassettentypen für unterschiedliche Werkstoffe
- Innovatives Spannsystem – stabile und präzise Verbindung zwischen Grundkörper, Kassetten und Wendeschneidplatten – ohne Justierarbeiten
- Einfacher Austausch der Wendeplatten in der Maschine
- Speziell designte Anstellwinkel der Wendeschneidplatten – ergeben einen sehr weichen Schnitt
- Hohes Zerspanungsvolumen durch große Spantiefen a_p bis 14 mm
- Moderne Schneidstoffe für optimale Zerspanungsergebnisse auf breitem Materialspektrum

Special features:

- Flexibility in heavy duty machining
- One basic body – many possibilities
- Simple change of the cartridges for face milling
- 4 cartridge types for different materials
- Innovative clamping system – stable and precise connection between basic body, cartridges and inserts – without adjusting operations
- Simple change of the insert in the machine
- Special designed setting angle of the insert – very smooth cut
- High cutting volume due to big cutting depths a_p up to 14 mm
- Modern cutting material for optimal cutting results on a wide material area

WSP Sorte Insert grade	HP.. 12		SP.. 20		SP.. 27		TP.. 31	
	Schnitttiefe Cutting depth [mm] APMX max	Vorschub Feed [mm] fz	Schnitttiefe Cutting depth [mm] APMX max	Vorschub Feed [mm] fz	Schnitttiefe Cutting depth [mm] APMX max	Vorschub Feed [mm] fz	Schnitttiefe Cutting depth [mm] APMX max	Vorschub Feed [mm] fz
P	1,0 4,0 6,0	0,26 0,38 0,5	1,0 6,0 10,0	0,28 0,45 0,6	1,0 9,0 14,0	0,35 0,50 0,65	1,0 7,0 13,0	0,25 0,40 0,6
M	1,0 4,0 6,0	0,2 0,30 0,4	1,0 6,0 10,0	0,25 0,38 0,5	-	-	1,0 7,0 13,0	0,2 0,32 0,5
K	1,0 4,0 6,0	0,3 0,42 0,55	1,0 6,0 10,0	0,30 0,50 0,7	-	-	-	-

Planfräskopf 45° / HP. 12
Face milling cutter 45° / HP. 12

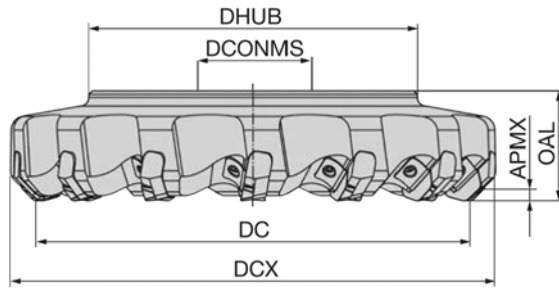

Abmessungen [mm] Dimensions [mm]							Artikelbezeichnung Item code	Bestell-Nr. Ordering No.	Verfügbarkeit Availability
DC	DCX	DCONMS	DHUB	OAL	APMX	ZEFF [☆]			
125	142	40	120	63	6	7	BF45 HP12.125BT Z07 R	5144138	○
160	176	40	120	63	6	9	BF45 HP12.160BT Z09 R	5144145	●
200	213	60	159	63	6	11	BF45 HP12.200BT Z11 R	5138580	●
250	266	60	190	63	6	14	BF45 HP12.250BT Z14 R	5144146	●
315	331	60	274	63	6	18	BF45 HP12.315BT Z18 R	5144147	●
400	416	60	274	80	6	18	BF45 HP12.400BT Z18 R	5136651	○
400	416	60	274	80	6	22	BF45 HP12.400BT Z22 R	5144148	○
500	516	60	274	80	6	22	BF45 HP12.500BT Z22 R	5144149	○
500	516	60	274	80	6	26	BF45 HP12.500BT Z26 R	5144150	○

Bestellbeispiel Order example: 1 Stück Piece 5144138 oder or BF45 HP12.125BT Z07 R





Fräser einsatzfertig montiert - exklusive Wendeschneidplatte

Milling cutter ready to use - exclusive Inserts

Hinweis: Linksausführung **L** auf Anfrage

Note: Left hand version **L** on request

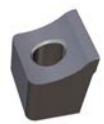
Ersatz-Kassette und Ersatzteile für Planfräskopf 45° HP12
Replacment-cartridge and spare parts for face milling cutter 45° HP12

	<p>Kassette CBT45 HP12 R inkl. Spannschraube Cartridge CBT45 HP12R incl. fixation screw 5118022</p>		<p>Spannschraube für Kassette Fixation screw for cartridge 5049762</p>		<p>Spannkeil Wedge clamp 5132639</p>		<p>Spannschraube für Spannkeil Fixation screw for wedgeclamp 5132480</p>
---	---	---	---	---	---	---	---

Bestellbeispiel Order example: 1 Stück Piece Kassette Cartridge 5118022 oder or CBT45 HP12 R

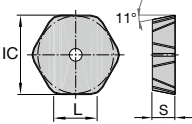
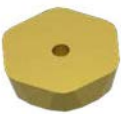
CEDC = Anzahl der Schneidkanten CEDC = Number of cutting edges	Artikelbezeichnung Item code	Schneidstoffsorte Cutting materials	Bestell-Nr. Ordering No.	Verfügbarkeit Availability	Abmessungen [mm] Dimensions [mm]		
					L	IC	S
  CEDC = 6	HPKN 1206 ADSN	BCP30M	5138418	○	12,7	22	6,35
	HPKN 1206 ADSN	BCP35M	5138419	●	12,7	22	6,35
	HPKN 1206 ADSN	BCP40M	5133930	●	12,7	22	6,35
	HPKN 1206 ADSN	BCM40M	5142231	●	12,7	22	6,35
	HPKN 1206 ADSN	BCK20M	5192090	●	12,7	22	6,35

Bestellbeispiel Order example: 10 Stück piece 5138418 oder or HPKN 1206 ADSN BCP30M

Empfehlung: Mindestens Aufnahme SK-60 verwenden!

Recommendation: Use at least chuck SK-60!

Planfräskopf 45° / SP.. 20
Face milling cutter 45° / SP.. 20

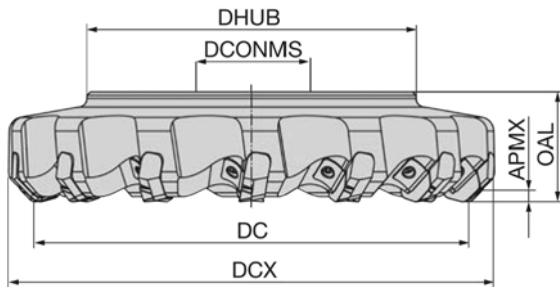





Abmessungen [mm] Dimensions [mm]							Artikelbezeichnung Item code	Bestell-Nr. Ordering No.	Verfügbarkeit Availability
DC	DCX	DCONMS	DHUB	OAL	APMX	ZEFF [⊙]			
125	147	40	120	63	10	7	BF45 SP20.125BT Z07 R	5144152	○
160	182	40	120	63	10	9	BF45 SP20.160BT Z09 R	5144153	⊙
200	222	60	159	63	10	11	BF45 SP20.200BT Z11 R	5144154	⊙
250	272	60	190	63	10	14	BF45 SP20.250BT Z14 R	5144156	⊙
315	337	60	274	63	10	18	BF45 SP20.315BT Z18 R	5144157	⊙
400	422	60	274	80	10	18	BF45 SP20.400BT Z18 R	5144158	○
400	422	60	274	80	10	22	BF45 SP20.400BT Z22 R	5144159	○
500	522	60	274	80	10	22	BF45 SP20.500BT Z22 R	5144160	○
500	522	60	274	80	10	26	BF45 SP20.500BT Z26 R	5144162	○

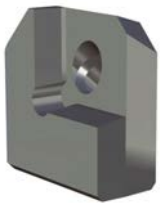

Bestellbeispiel Order example: 1 Stück Piece 5144152 oder or BF45 SP20.125BT Z07 R
Fräser einsatzfertig montiert - exklusive Wendeschneidplatte
Milling cutter ready to use - exclusive Inserts

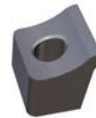
Hinweis: Linksausführung **L** auf Anfrage
Note: Left hand version **L** on request

Ersatz-Kassette und Ersatzteile für Planfräskopf 45° SP20
Replacement-cartridge and spare parts for face milling cutter 45° SP20

	<p>Kassette CBT45 SP20 R inkl. Spannschraube Cartridge CBT45 SP20 R incl. fixation screw 5136693</p>	 <p>Spannschraube für Kassette Fixation screw for cartridge 5049762</p>	 <p>Spannkeil Wedge clamp 5132639</p>	 <p>Spannschraube für Spannkeil Fixation screw for wedgeclamp 5132480</p>
---	--	---	---	---

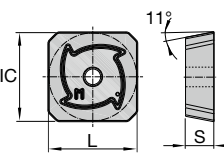
Bestellbeispiel Order example: 1 Stück Piece Kassette Cartridge 5136693 oder or CBT45 SP20 R

CEDC = Anzahl der Schneidkanten CEDC = Number of cutting edges	Artikelbezeichnung Item code	Schneidstoffsorte Cutting materials	Bestell-Nr. Ordering No.	Verfügbarkeit Availability	Abmessungen [mm] Dimensions [mm]		
					L	IC	S
  CEDC = 4	SPKN 2006 ADSN	BCP20M	5173433	○	20	20	6,35
	SPKN 2006 ADSN	BCP25M	5190694	●	20	20	6,35
	SPKN 2006 ADSN	BCP30M	5190697	○	20	20	6,35
	SPKN 2006 ADSN	BCP35M	5137986	●	20	20	6,35
	SPKN 2006 ADSN	BCM40M	5137989	●	20	20	6,35
	SPKN 2006 ADSN	BCK15M	5190708	○	20	20	6,35
	SPKN 2006 ADSN	BCK20M	5176323	●	20	20	6,35

Bestellbeispiel Order example: 10 Stück piece 5173433 oder or SPKN 2006 ADSN BCP20M

Empfehlung: Mindestens Aufnahme SK-60 verwenden!
Recommendation: Use at least chuck SK-60!

● Verfügbar ab Lager Available from stock
⊙ Kurzfristig lieferbar Available at short notice
○ Lieferzeit auf Anfrage Delivery time on request

Planfräskopf 45° / SP.. 27
Face milling cutter 45° / SP.. 27

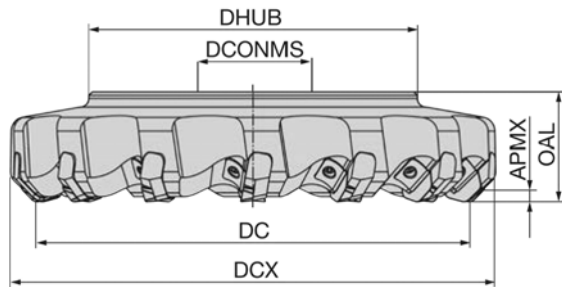





Abmessungen [mm] Dimensions [mm]							Artikelbezeichnung Item code	Bestell-Nr. Ordering No.	Verfügbarkeit Availability
DC	DCX	DCONMS	DHUB	OAL	APMX	ZEFF [☆]			
125	155	40	120	63	14	7	BF45 SP27.125BT Z07 R	5145457	○
160	190	40	120	63	14	9	BF45 SP27.160BT Z09 R	5145459	●
200	230	60	159	63	14	11	BF45 SP27.200BT Z11 R	5145460	●
250	280	60	190	63	14	14	BF45 SP27.250BT Z14 R	5145461	●
315	345	60	274	63	14	18	BF45 SP27.315BT Z18 R	5145465	●
400	430	60	274	80	14	18	BF45 SP27.400BT Z18 R	5145467	○
400	430	60	274	80	14	22	BF45 SP27.400BT Z22 R	5145569	○
500	530	60	274	80	14	22	BF45 SP27.500BT Z22 R	5145470	○
500	530	60	274	80	14	26	BF45 SP27.500BT Z26 R	5145471	○

Fräser einsatzfertig montiert - exklusive Wendeschneidplatte
Milling cutter ready to use - exclusive Inserts

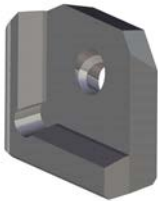
Hinweis: Linksausführung L auf Anfrage
Note: Left hand version L on request

Ersatz-Kassette und Ersatzteile für Planfräskopf 45° SP27
Replacement-cartridge and spare parts for face milling cutter 45° SP27

	<p>Kassette CBT45 SP27 R inkl. Spannschraube Cartridge CBT45 SP27 R incl. fixation screw 5136694</p>		<p>Spannschraube für Kassette Fixation screw for cartridge 5049762</p>		<p>Spannkeil Wedge clamp 5132639</p>		<p>Spannschraube für Spannkeil Fixation screw for wedgeclamp 5132480</p>
---	--	---	---	---	---	---	---

Bestellbeispiel Order example: 1 Stück Piece Kassette Cartridge 5136694 oder or CBT45 SP27 R

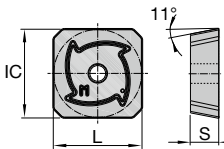
CEDC = Anzahl der Schneidkanten CEDC = Number of cutting edges	Artikelbezeichnung Item code	Schneidstoffsorte Cutting materials	Bestell-Nr. Ordering No.	Verfügbarkeit Availability	Abmessungen [mm] Dimensions [mm]		
					L	IC	S
 CEDC = 4	SPKN 2706 ADSN	BPC30M	5178730	○	27	27	6,35
	SPKN 2706 ADSN	BPC35M	5138422	●	27	27	6,35

Bestellbeispiel Order example: 1 Stück Piece 5145457 oder oder BF45 SP27.125BT Z07 R
Empfehlung: Mindestens Aufnahme SK-60 verwenden!
Recommendation: Use at least chuck SK-60!

- Verfügbar ab Lager Available from stock
- Kurzfristig lieferbar Available at short notice
- Lieferzeit auf Anfrage Delivery time on request

Planfräskopf 45° / TP.. 31
Face milling cutter 45° / TP.. 31

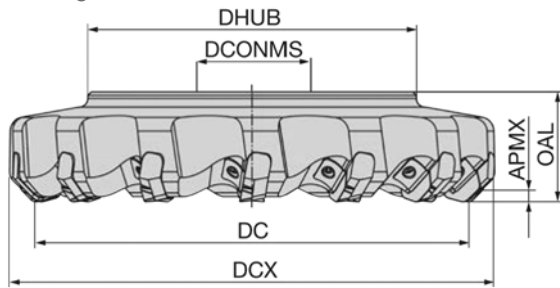





Abmessungen [mm] Dimensions [mm]							Artikelbezeichnung Item code	Bestell-Nr. Ordering No.	Verfügbarkeit Availability
DC	DCX	DCONMS	DHUB	OAL	APMX	ZEFF [☆]			
125	153	40	120	63	13	7	BF45 TP31.125BT Z07 R	5144164	○
160	188	40	120	63	13	9	BF45 TP31.160BT Z09 R	5144165	●
200	228	60	159	63	13	11	BF45 TP31.200BT Z11 R	5144167	●
250	278	60	190	63	13	14	BF45 TP31.250BT Z14 R	5144169	●
315	343	60	274	63	13	18	BF45 TP31.315BT Z18 R	5144171	●
400	428	60	274	80	13	18	BF45 TP31.400BT Z18 R	5144172	○
400	428	60	274	80	13	22	BF45 TP31.400BT Z22 R	5144174	○
500	528	60	274	80	13	22	BF45 TP31.500BT Z22 R	5144175	○
500	528	60	274	80	13	26	BF45 TP31.500BT Z26 R	5144178	○

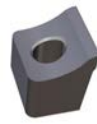

Fräser einsatzfertig montiert - exklusive Wendeschneidplatte
Milling cutter ready to use - exclusive Inserts

Hinweis: Linksausführung L auf Anfrage
Note: Left hand version L on request

Ersatz-Kassette und Ersatzteile für Planfräskopf 45° TP31
Replacement-cartridge and spare parts for face milling cutter 45° TP31

	<p>Kassette CBT45 TP31 R inkl. Spannschraube Cartridge CBT45 TP31 R incl. fixation screw 5136695</p>	 <p>Spannschraube für Kassette Fixation screw for cartridge 5049762</p>	 <p>Spannkeil Wedge clamp 5132639</p>	 <p>Spannschraube für Spannkeil Fixation screw for wedgeclamp 5132480</p>
---	--	---	---	---

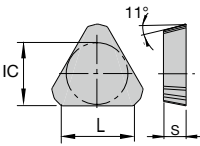
Bestellbeispiel Order example: 1 Stück Piece Kassette Cartridge 5136695 oder or CBT45 TP31 R

CEDC = Anzahl der Schneidkanten CEDC = Number of cutting edges	Artikelbezeichnung Item code	Schneidstoffsorte Cutting materials	Bestell-Nr. Ordering No.	Verfügbarkeit Availability	Abmessungen [mm] Dimensions [mm]		
					L	IC	S
  CEDC = 3	TPLN3106 ADSN	BCP30M	5190714	○	31,75	18	6,35
	TPLN 3106 ADSN	BCP35M	5138420	●	31,75	18	6,35
	TPLN 3106 ADSN	BCP40M	5138421	○	31,75	18	6,35
	TPLN 3106 ADSN	BCM40M	5081021	●	31,75	18	6,35

Bestellbeispiel Order example: 1 Stück Piece 5144164 oder or BF45 TP31.125BT Z07 R
Empfehlung: Mindestens Aufnahme SK-60 verwenden!
Recommendation: Use at least chuck SK-60!

- Verfügbar ab Lager Available from stock
- Kurzfristig lieferbar Available at short notice
- Lieferzeit auf Anfrage Delivery time on request

Schnittwertempfehlung für Fräser 45°
Cutting data recommendations for Milling Cutter 45°

ISO 513	BZG	Kühlung Cooling			Schnittdaten v _c [m/min] Cutting data v _c [m/min]				
		MMS/Luft MMS/Air	Trocken Dry	Nass Wet	BCP20M BCP25M	BCP30M BCP35M BCP40M	BCM35M	BCM40M	
					V _c = m/min				
P	P1	●	●		210 - 290	180 - 260	---	200 - 260	
	P2	●	●		170 - 250	160 - 200	---	160 - 220	
	P3	●	●		140 - 190	120 - 160	---	130 - 170	
	P4	●	●		120 - 160	110 - 150	---	120 - 150	
	P5	●	●		140 - 200	120 - 170	---	130 - 190	
M	M1	●	●	●	100 - 150	---	120 - 180	110 - 160	
	M2	●	●	●	70 - 110	---	80 - 130	70 - 120	
K	K1	●	●		200 - 280	---	---	---	
	K2	●	●		130 - 180	---	---	---	
	K3	●	●		160 - 210	---	---	---	
N	N1	●	●	●	---	---	---	---	
	N2	●	●	●	---	---	---	---	
	N3	●	●	●	---	---	---	---	
	N4	●	●	●	---	---	---	---	
S	S1	●	●	●	---	---	70 - 90	55 - 70	
	S2	●	●	●	---	---	35 - 45	25 - 35	
	S3	●	●	●	---	---	50 - 100	30 - 70	
	S4	●	●	●	---	---	30 - 80	25 - 50	
H	H1	45 - 54 HRC	●	●	---	---	100 - 140	---	
	H2	55 - 63 HRC	●	●	---	---	80 - 120	---	
	H3	64 - 66 HRC	●	●	---	---	---	---	
	H4	50 - 60 HRC	●	●	---	---	90 - 130	---	

Schnittwertempfehlung für BULLtec®

Bei Verwendung des Systems BULLtec® 2.0 ist eine Reduktion der Schnittdaten von 30 - 40% zu beachten!

Cutting data recommendations for BULLtec®

When using the Bulltec® 2.0 system, a reduction in cutting data of 30 - 40% should be noted!

- empfohlene Anwendung recommended application
- alternative Anwendung um 30 - 50 % reduzieren
alternative application reduced by 30 - 50 %

Schnittdaten v _c [m/min] Cutting data v _c [m/min]						
	BCK15M BCK20M	BWN10M	BCN10M	BCS35M BCS40M	BCH05M BCH10M	BCH30M
	220 - 280	---	---	---	240 - 350	230 - 300
	190 - 240	---	---	---	200 - 300	200 - 260
	150 - 190	---	---	---	170 - 250	160 - 220
	---	---	---	---	---	---
	140 - 200	---	---	---	160 - 260	150 - 230
	---	---	---	100 - 150	---	---
	---	---	---	70 - 110	---	---
	220 - 360	---	---	---	280 - 490	230 - 380
	150 - 190	---	---	---	160 - 300	160 - 210
	170 - 240	---	---	---	220 - 340	180 - 260
	---	1200 - 2400	1500 - 3000	---	---	---
	---	240 - 550	310 - 750	---	---	---
	---	120 - 380	160 - 480	---	---	---
	---	400 - 500	600 - 800	---	---	---
	---	---	---	65 - 80	---	---
	---	---	---	30 - 45	---	---
	---	---	---	40 - 90	---	---
	---	---	---	30 - 70	---	---
	100 - 140	---	---	---	110 - 160	100 - 140
	80 - 120	---	---	---	90 - 130	80 - 120
	---	---	---	---	70 - 110	---
	90 - 130	---	---	---	100 - 150	90 - 130

BETAtec 90P Feed

Multifunktional Multifunctional



- Multifunktionales Werkzeugsystem für höchste Produktivität
- Multifunctional tool system for highest productivity



boehlerit

Fräsen 90°
Milling 90°



90°



	Aufsteckfräser 90° Face milling cutter 90°	Schafffräser 90° End milling cutter 90°	Einschraubfräser 90° Screw on type 90°
Ausführung Execution			
Durchmesserbereich metrisch Diameter range metric	Ø 40 - 125 mm	Ø 12 - 40 mm	Ø 16 - 32 mm
Durchmesserbereich inch Diameter range inch	Ø 1 1/2" - 5"	Ø 1/2" - 1 1/2"	-
Plattengröße Insert size	AP.. 10, AP.. 16	AP.. 10, AP.. 16	AP.. 10

Besondere Merkmale:

- Hybride Geometrie
- ISO Platte mit Helix Schneidkante und präzisiertem Schnitt
- Vielfältiges Geometrieangebot
- Vielfältiges Sortenangebot
- Beste Zerspanungsergebnisse nur in Kombination von Boehlerit Wendeschneidplatte + Boehlerit Werkzeuge erreichbar
- BP und BM Geometrie nur als Schruppvariante einsetzbar
- Einschraubwerkzeuge in Kombination mit den schwingungsdämpfenden VHM-Verlängerungen
- Spezielle Geometrie für mittlere Bearbeitung MP2 und für Schruppbearbeitung RP2 von Stahl

Special features:

- Hybrid geometry
- ISO insert with helix cutting edge and accurate cutting
- Varied geometry offer
- Varied grade offer
- Best cutting results only achievable in combination with Boehlerit inserts + Boehlerit tools
- BP and BM geometry only applicable in roughing version
- Screw on type tools in combination with vibration damping solid carbide extensions
- Special geometry for medium machining MP2 and for roughing RP2 of steel

90° Fräsparameter 90° Milling parameter

WSP Geometrie Insert geometry	A.P.T 10		A.P.T 16	
	Schnitttiefe* Cutting depth* [mm] APMX max	Vorschub* Feed* [mm] f _z	Schnitttiefe* Cutting depth* [mm] APMX max	Vorschub* Feed* [mm] f _z
MP2	0,5 3,0 9,0	0,1 0,15 0,2	1,0 8,0 15,0	0,1 0,15 0,2
MM2	0,5 3,0 9,0	0,1 0,15 0,2	1,0 8,0 15,0	0,1 0,15 0,2
MN2	0,5 5,0 9,0	0,1 0,16 0,24	1,0 9,0 15,0	0,1 0,16 0,26
RP2	0,5 3,0 9,0	0,2 0,22 0,28	1,0 8,0 15,0	0,2 0,25 0,3
RK2	0,5 3,0 9,0	0,2 0,25 0,3	1,0 8,0 15,0	0,2 0,27 0,35

Walzenstirfräser Helical cutter

WSP Geometrie Insert geometry	A.P.T 10		A.P.T 16	
	Schnittbreite* Cutting width* [D x %] a _e max	Vorschub* Feed* [mm] f _z	Schnittbreite* Cutting width* [D x %] a _e max	Vorschub* Feed* [mm] f _z
MP2	5 - 70%	0,1 0,15 0,2	5 - 70%	0,1 0,15 0,2
MM2	5 - 70%	0,1 0,15 0,2	5 - 70%	0,1 0,15 0,2
MN2	5 - 80%	0,1 0,16 0,24	5 - 80%	0,1 0,16 0,26
RP2	5 - 70%	0,2 0,22 0,28	5 - 70%	0,2 0,25 0,3
RK2	5 - 70%	0,2 0,25 0,3	5 - 70%	0,2 0,27 0,35

Eintauchwinkel Ramping angle





Durchmesser Fräser Diameter Milling cutter	Eintauchwinkel Fräser α max. Ramping angle Milling cutter α max. A.P.T 10	Eintauchwinkel Fräser α max. Ramping angle Milling cutter α max. A.P.T 16
	Ø 16	4,5°
Ø 20	3,8°	-
Ø 25	2,5°	5,2°
Ø 32	1,7°	3,4°
Ø 40	1,3°	2,5°
Ø 50	0,9°	1,8°
Ø 63	0,7°	1,3°
Ø 80	0,5°	1,0°
Ø 100	-	0,7°
Ø 125	-	0,6°

Schnittwertempfehlungen siehe Seite 130
Cutting data recommendations page 130

* Angegebene Schnittdaten sind als Richtwert zu sehen, welche durch Versuche für jeden Anwendungsfall separat optimiert werden können.
* Recommended cutting data has to be seen as a reference which can be optimised for each application through trials separately.

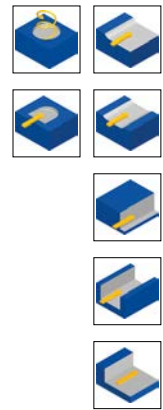
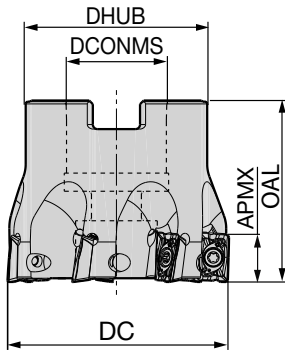

Aufsteckfräser 90° / AP.. 10
Face milling cutter 90° / AP.. 10

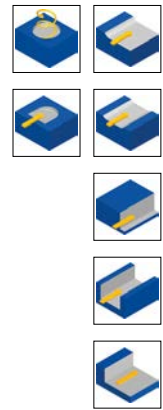
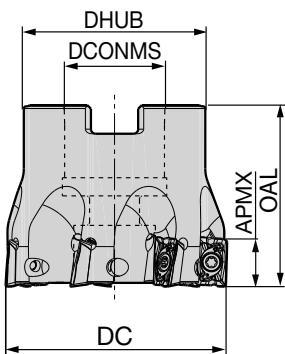

Abmessungen [mm] Dimensions [mm]						Artikelbezeichnung	Bestell-Nr.	Verfügbarkeit	Ersatzteile	
DC	DCONMS	DHUB	OAL	APMX	ZEFF	Item code	Ordering No.	Availability	Spare parts	
40	16	32	40	9	6	BF90 AP10.040 Z06	5079217	●	 Spannschraube Fixation screw AP17-25055 5085710 M _A = 2Nm	 Torx-Schlüssel Torque wrench IP8 5088519
50	22	40	40	9	6	BF90 AP10.050 Z06	5079218	●		
50	22	40	40	9	7	BF90 AP10.050 Z07	5079220	●		
63	22	46	40	9	8	BF90 AP10.063 Z08	5079221	●		
80	27	54	50	9	10	BF90 AP10.080 Z10	5079222	○		

Aufsteckfräser 90° / AP.. 10 / INCH
Face milling cutter 90° / AP.. 10 / INCH



Abmessungen [INCH] Dimensions [INCH]						Artikelbezeichnung	Bestell-Nr.	Verfügbarkeit	Ersatzteile	
DC	DCONMS	DHUB	OAL	APMX	ZEFF	Item code	Ordering No.	Availability	Spare parts	
1.5	0.75	1.375	1.50	0.354	6	BFU90 AP10.1500 Z06	5132825	○	 Spannschraube Fixation screw AP17-25055 5085710 M _A = 2Nm	 Torx-Schlüssel Torque wrench IP8 5088519
2.0	0.75	1.750	1.50	0.354	6	BFU90 AP10.2000 Z06	5132826	○		
2.0	0.75	1.750	1.50	0.354	7	BFU90 AP10.2000 Z07	5132827	○		
2.5	1.00	2.250	1.75	0.354	8	BFU90 AP10.2500 Z08	5132829	○		
3.0	1.00	2.250	1.75	0.354	10	BFU90 AP10.3000 Z10	5132830	○		

Schaftfräser 90° / AP.. 10
End milling cutter 90° / AP.. 10

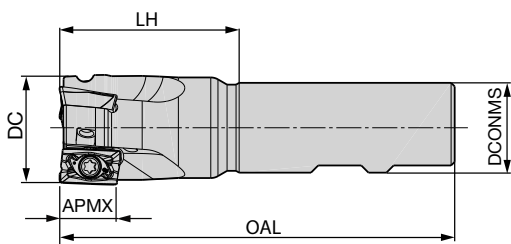

Abmessungen [mm] Dimensions [mm]						Artikelbezeichnung Item code	Schaft Shank	Bestell-Nr. Ordering No.	Verfügbarkeit Availability	Ersatzteile Spare parts	
DC	DCONMS	LH	OAL	APMX	ZEFF [⊕]					Spannschraube Fixation screw AP17-25055 5085710 M _A = 2Nm	Torx-Schlüssel Torque wrench IP8 5088519
12	16	32	80	9	1	BE90 AP10.012 Z01	HB	5079223	○		
12	16	32	120	9	1	BE90 AP10.012 Z01 120	HA	5104926	○		
16	16	37	85	9	2	BE90 AP10.016 Z02	HB	5079224	●		
16	16	37	130	9	2	BE90 AP10.016 Z02 130	HA	5104927	●		
20	20	40	90	9	3	BE90 AP10.020 Z03	HB	5079225	●		
20	20	40	150	9	3	BE90 AP10.020 Z03 150	HA	5104928	●		
25	25	49	105	9	4	BE90 AP10.025 Z04	HB	5079226	●		
25	25	49	170	9	4	BE90 AP10.025 Z04 170	HA	5104930	●		
32	25	54	110	9	5	BE90 AP10.032 Z05	HB	5079227	●		
32	25	54	195	9	5	BE90 AP10.032 Z05 195	HA	5104931	●		

Schaftfräser 90° / AP.. 10 / INCH
End milling cutter 90° / AP.. 10 / INCH

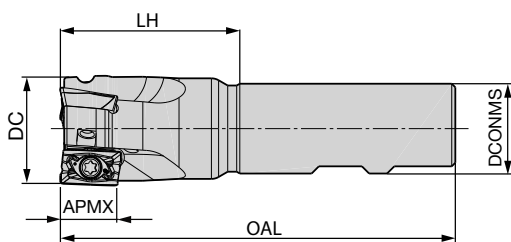



Abmessungen [INCH] Dimensions [INCH]						Artikelbezeichnung Item code	Schaft Shank	Bestell-Nr. Ordering No.	Verfügbarkeit Availability	Ersatzteile Spare parts	
DC	DCONMS	LH	OAL	APMX	ZEFF [⊕]					Spannschraube Fixation screw AP17-25055 5085710 M _A = 2Nm	Torx-Schlüssel Torque wrench IP8 5088519
0.500	0.625	1.250	3.250	0.354	1	BEU90 AP10.0500 Z01	HB	5132831	○		
0.625	0.625	1.375	3.250	0.354	2	BEU90 AP10.0625 Z02	HB	5132833	○		
0.750	0.750	1.500	3.375	0.354	3	BEU90 AP10.0750 Z03	HB	5132834	○		
1.000	1.000	2.000	4.000	0.354	4	BEU90 AP10.1000 Z04	HB	5132835	○		
1.250	1.000	2.000	4.000	0.354	5	BEU90 AP10.1250 Z05	HB	5132836	○		

- Verfügbar ab Lager Available from stock
- ⦿ kurzfristig lieferbar available at short notice
- Lieferzeit auf Anfrage Delivery time on request

Bestellbeispiel Order example: 1 Stück piece 5079223 oder or BE90 AP10.012 Z01

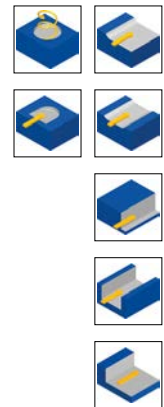
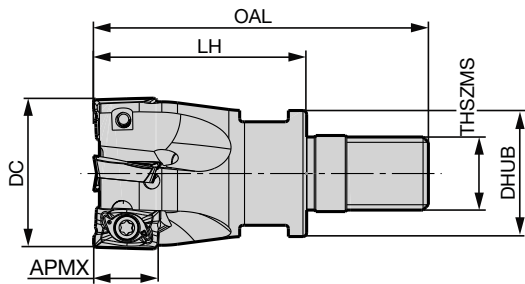
Einschraubfräser 90° / AP.. 10 Screw on type 90° / AP.. 10



Abmessungen [mm] Dimensions [mm]							Artikelbezeichnung Item code	Bestell-Nr. Ordering No.	Verfügbarkeit Availability	Ersatzteile Spare parts	
DC	DHUB	LH	OAL	THSZMS	APMX	ZEFF \odot					
16	12,7	23	41	M8	9	2	BS90 AP10.016 Z02 M8	5079228	●	 Spannschraube Fixation screw AP17-25055 5085710 M _A = 2Nm	 Torx-Schlüssel Torque wrench IP8 5088519
20	17,7	30	50	M10	3	BS90 AP10.020 Z03 M10	5079229	●			
25	20,7	35	57	M12	9	4	BS90 AP10.025 Z04 M12	5079230	●		
32	28,7	43	67	M16	9	5	BS90 AP10.032 Z05 M16	5079231	●		

Die passenden Hartmetallverlängerungen finden Sie ab Seite 294
You will find the matching carbide extensions from page 294

Aufsteckfräser 90° / AP.. 10 Face milling cutter 90° / AP.. 10

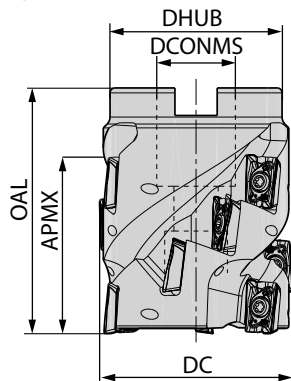

Abmessungen [mm] Dimensions [mm]								Artikelbezeichnung Item code	Bestell-Nr. Ordering No.	Verfügbarkeit Availability	Ersatzteile Spare parts	
DC	DCONMS	DHUB	OAL	APMX	ZEFF \odot	Anzahl WSP Pieces Insert						
40	16	35	50	37	3	12	BFH90 AP10.040 Z03 037	5108639	●	 Spannschraube Fixation screw AP17-25055 5085710 M _A = 2Nm	 Torx-Schlüssel Torque wrench IP8 5088519	
40	16	35	50	37	5	20	BFH90 AP10.040 Z05 037	5108640	●			
50	22	48	60	46	3	15	BFH90 AP10.050 Z03 046	5108641	●			
50	22	48	60	46	5	25	BFH90 AP10.050 Z05 046	5108642	●			
63	27	53	60	46	4	20	BFH90 AP10.063 Z04 046	5108643	●			
63	27	53	60	46	7	35	BFH90 AP10.063 Z07 046	5108644	●			

Bestellbeispiel Order example: 1 Stück piece 5079228 oder or BS90 AP10.016 Z02 M8

Schaftfräser 90° / AP.. 10
End milling cutter 90° / AP.. 10

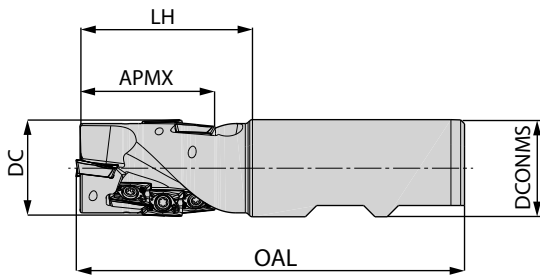

Abmessungen [mm]		Dimensions [mm]					Artikelbezeichnung Item code	Schaft Shank	Bestell-Nr. Ordering No.	Verfügbarkeit Availability	Ersatzteile Spare parts	
DC	DCONMS	LH	OAL	APMX	ZEFF	Anzahl WSP Pieces Insert					Spann- schraube Fixation screw AP17-25055 5085710 M _A = 2Nm	Torx- Schlüssel Torque wrench IP8 5088519
20	20	37	87	28	2	6	BEH90 AP10.020 Z02 028	HB	5108635	●		
25	25	49	105	37	2	8	BEH90 AP10.025 Z02 037	HB	5106983	●		
32	32	55	115	46	2	10	BEH90 AP10.032 Z02 046	HB	5108636	⦿		
32	32	55	115	46	3	15	BEH90 AP10.032 Z03 046	HB	5108637	●		
40	32	70	130	55	3	18	BEH90 AP10.040 Z03 055	HB	5108638	●		

CEDC = Anzahl der Schneidkanten CEDC = Number of cutting edges	Artikelbezeichnung Item code	Schneidstoffsorte Cutting materials	Bestell-Nr. Ordering No.	Verfügbarkeit Availability	Abmessungen [mm] Dimensions [mm]				
					L	IC	S	D1	RE
 CEDC = 2	APKT 100304 SR-MP2	BCP25M	5085192	●	10	6,7	3,5	2,8	0,4
	APKT 100304 SR-MP2	BCP35M	5085190	●	10	6,7	3,5	2,8	0,4
	APKT 100304 SR-MM2	BCM40M	5085158	●	10	6,7	3,5	2,8	0,4
	APHT 100304 FR-MN2	BCN10M	5092158	●	10	6,7	3,5	2,8	0,4
	APHT 100304 FR-MN2	BWN10M	5092159	●	10	6,7	3,5	2,8	0,4
	APKT 100304 SR-RP2	BCP30M	5092141	●	10	6,7	3,5	2,8	0,4
	APKT 100304 SR-RP2	BCP35M	5085194	●	10	6,7	3,5	2,8	0,4
	APKT 100304 SR-RP2	BCP40M	5092143	●	10	6,7	3,5	2,8	0,4
	APKT 100304 SR-RK2	BCK15M	5092144	●	10	6,7	3,5	2,8	0,4
	APKT 100304 SR-RK2	BCK20M	5085202	●	10	6,7	3,5	2,8	0,4

- Verfügbar ab Lager Available from stock
- ⦿ kurzfristig lieferbar available at short notice
- Lieferzeit auf Anfrage Delivery time on request

Bestellbeispiel Order example: 1 Stück piece 5108635 oder or BEH90 AP10.020 Z02 028

Aufsteckfräser 90° / AP.. 16
Face milling cutter 90° / AP.. 16

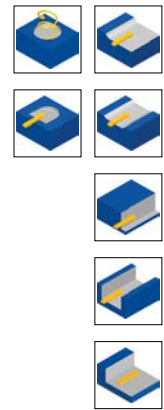
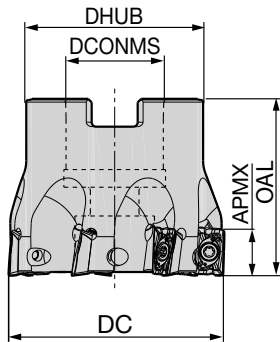

Abmessungen [mm]		Dimensions [mm]				Artikelbezeichnung Item code	Bestell-Nr. Ordering No.	Verfügbarkeit Availability	Ersatzteile Spare parts	
DC	DCONMS	DHUB	OAL	APMX	ZEFF☼				Spann- schraube Fixation screw AP02-40095 5085711 M _A = 3Nm	Torx- Schlüssel Torque wrench IP15 5088520
40	16	32	40	15	4	BF90 AP16.040 Z04	5079232	●		
50	22	42	40	15	5	BF90 AP16.050 Z05	5079234	●		
63	22	48	40	15	6	BF90 AP16.063 Z06	5079236	●		
80	27	58	50	15	7	BF90 AP16.080 Z07	5079237	●		
100	32	76	50	15	8	BF90 AP16.100 Z08	5079238	●		
125	40	90	63	15	9	BF90 AP16.125 Z09	5079239	○		

Aufsteckfräser 90° / AP.. 16 / INCH
Face milling cutter 90° / AP.. 16 / INCH

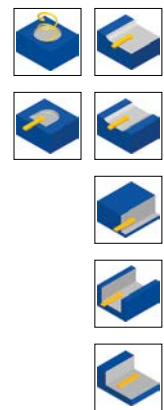
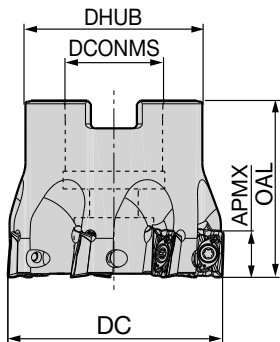

Abmessungen [INCH]		Dimensions [INCH]				Artikelbezeichnung Item code	Bestell-Nr. Ordering No.	Verfügbarkeit Availability	Ersatzteile Spare parts	
DC	DCONMS	DHUB	OAL	APMX	ZEFF☼				Spann- schraube Fixation screw AP02-40095 5085711 M _A = 3Nm	Torx- Schlüssel Torque wrench IP15 5088520
2.0	0.75	1.75	1.50	0.590	5	BFU90 AP16.2000 Z05	5132842	○		
2.5	1.00	2.25	1.75	0.590	6	BFU90 AP16.2500 Z06	5132843	○		
3.0	1.00	2.25	1.75	0.590	7	BFU90 AP16.3000 Z07	5132844	○		
4.0	1.50	3.75	2.25	0.590	8	BFU90 AP16.4000 Z08	5132845	○		
5.0	1.50	3.75	2.50	0.590	9	BFU90 AP16.5000 Z09	5132846	○		



ISO 90P

Systemgröße 16 System size 16



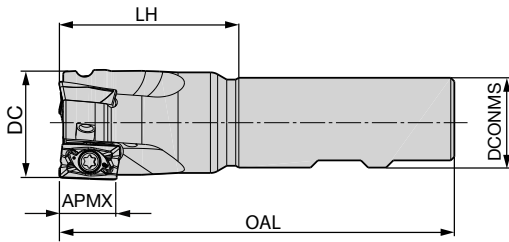

Schaftfräser 90° / AP. 16 End milling cutter 90° / AP. 16

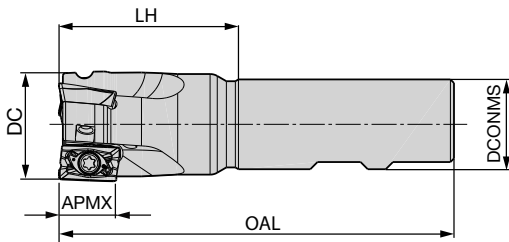

Abmessungen [mm] Dimensions [mm]						Artikelbezeichnung Item code	Schaft Shank	Bestell-Nr. Ordering No.	Verfügbarkeit Availability	Ersatzteile Spare parts	
DC	DCONMS	OAL	APMX	LH	ZEFF						
25	20	100	15	40	2	BE90 AP16.025 Z02	HB	5079240	●	 Spannschraube Fixation screw AP02-40095 5085711 M _A = 3Nm	 Torx-Schlüssel Torque wrench IP15 5088520
25	20	200	15	40	2	BE90 AP16.025 Z02 200	HA	5102014	●		
32	25	110	15	50	3	BE90 AP16.032 Z03	HB	5079241	●		
32	25	200	15	50	3	BE90 AP16.032 Z03 200	HA	5102015	●		
40	32	115	15	55	4	BE90 AP16.040 Z04	HB	5079242	●		

Schaftfräser 90° / AP. 16 / INCH End milling cutter 90° / AP. 16 / INCH



Abmessungen [INCH] Dimensions [INCH]						Artikelbezeichnung Item code	Schaft Shank	Bestell-Nr. Ordering No.	Verfügbarkeit Availability	Ersatzteile Spare parts	
DC	DCONMS	OAL	APMX	LH	ZEFF						
1.00	1.00	4.0	0.590	2.00	2	BEU90 AP16.1000 Z02	HB	5132847	○	 Spannschraube Fixation screw AP02-40095 5085711 M _A = 3Nm	 Torx-Schlüssel Torque wrench IP15 5088520
1.25	1.00	4.5	0.590	2.25	3	BEU90 AP16.1250 Z03	HB	5132848	○		
1.50	1.25	4.5	0.590	2.25	4	BEU90 AP16.1500 Z04	HB	5132849	○		

- Verfügbar ab Lager Available from stock
- kurzfristig lieferbar available at short notice
- Lieferzeit auf Anfrage Delivery time on request

Bestellbeispiel Order example: 1 Stück piece 5079240 oder or BE90 AP16.025 Z02

Aufsteckfräser 90° / AP.. 16
Face milling cutter 90° / AP.. 16

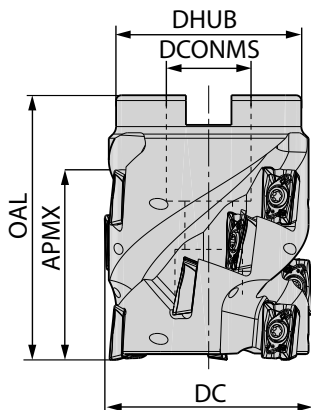

Abmessungen [mm] Dimensions [mm]							Artikelbezeichnung Item code	Bestell-Nr. Ordering No.	Verfügbarkeit Availability	Ersatzteile Spare parts	
DC	DCONMS	DHUB	OAL	APMX	ZEFF	Anzahl WSP Pieces Insert					
50	27	48	50	30	3	6	BFH90 AP16.050 Z03 030	5127230	●	 Spannschraube Fixation screw AP02-40095 5085711 M _A = 3Nm	 Torx-Schlüssel Torque wrench IP15 5088520
63	27	55	60	44	4	12	BFH90 AP16.063 Z04 044	5127231	●		
80	32	70	60	44	5	15	BFH90 AP16.080 Z05 044	5127232	●		
100	40	88	60	44	6	18	BFH90 AP16.100 Z06 044	5127233	●		
125	40	95	60	44	7	21	BFH90 AP16.125 Z07 044	5127234	●		

Schaftfräser 90° / AP.. 16
End milling cutter 90° / AP.. 16

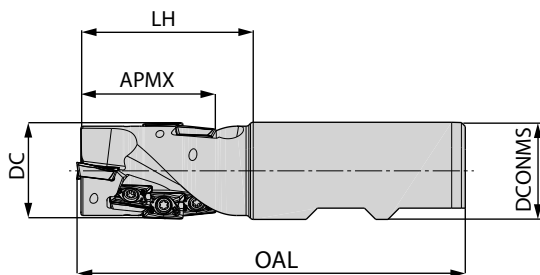

Abmessungen [mm] Dimensions [mm]							Artikelbezeichnung Item code	Schaft Shank	Bestell-Nr. Ordering No.	Verfügbarkeit Availability	Ersatzteile Spare parts	
DC	DCONMS	LH	OAL	APMX	ZEFF	Anzahl WSP Pieces Insert						
25	25	38	95	29	1	3	BEH90 AP16.025 Z01 029	HB	5127225	●	 Spannschraube Fixation screw AP02-40095 5085711 M _A = 3Nm	 Torx-Schlüssel Torque wrench IP15 5088520
32	32	53	115	44	2	6	BEH90 AP16.032 Z02 044	HB	5127228	●		
40	32	65	130	58	2	6	BEH90 AP16.040 Z02 058	HB	5127229	●		

ISO 90P

Systemgröße 16 System size 16

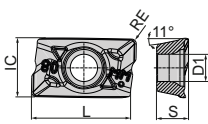

CEDC = Anzahl der Schneidkanten CEDC = Number of cutting edges	Artikelbezeichnung Item code	Schneidstoffsorte Cutting materials	Bestell-Nr. Ordering No.	Verfügbarkeit Availability	Abmessungen [mm] Dimensions [mm]					
					L	IC	S	D1	RE	
 <p>CEDC = 2</p>	APKT 160408 SR-MP2	BCP25M	5085147	●	16	9,6	5,26	4,5	0,8	
	APKT 160408 SR-MP2	BCP35M	5085140	●	16	9,6	5,26	4,5	0,8	
	APKT 160408 SR-MM2	BCM40M	5080859	●	16	9,6	5,26	4,5	0,8	
	APHT 160408 FR-MN2	BCN10M	5092154	●	16	9,52	5,26	4,5	0,8	
	APHT 160408 FR-MN2	BWN10M	5092155	●	16	9,52	5,26	4,5	0,8	
	APKT 160408 SR-RP2	BCP30M	5092136	●	16	9,6	5,26	4,5	0,8	
	APKT 160408 SR-RP2	BCP35M	5085148	●	16	9,6	5,26	4,5	0,8	
	APKT 160408 SR-RP2	BCP40M	5092137	●	16	9,6	5,26	4,5	0,8	
	APKT 160408 SR-RK2	BCK15M	5092140	●	16	9,6	5,26	4,5	0,8	
	APKT 160408 SR-RK2	BCK20M	5085153	●	16	9,6	5,26	4,5	0,8	

- Verfügbar ab Lager Available from stock
- ⦿ kurzfristig lieferbar available at short notice
- Lieferzeit auf Anfrage

Bestellbeispiel Order example: 10 Stück pieces 5085147 oder or APKT 160408 SR-MP2 BCP25M

	Aufsteckfräser 90° Face milling cutter 90°	Schafffräser 90° End milling cutter 90°	Einschraubfräser 90° Screw on type 90°
Ausführung Execution			
Durchmesserbereich metrisch Diameter range metric	Ø 32 - 160 mm	Ø 10 - 40 mm	Ø 10 - 40 mm
Durchmesserbereich inch Diameter range inch	Ø 1 1/2" - 5"	Ø 1/2" - 1 1/2"	Ø 3/4" - 1"
Plattengröße Insert size	LP.. 06, LD.. 10, LD.. 18	LP.. 06, LD.. 10, LD..18	LP.. 06, LD.. 10

Besondere Merkmale: Fräsen 90°

- Multifunktionales Werkzeugsystem für höchste Produktivität
- 1 Grundkörper für 2 Bearbeitungsverfahren = Multifunktional
- Erleichterung der Lagerhaltung und der Werkzeugbeschaffung durch weniger Artikel
- Exakte 90° Schulter bis ca. 1/2 Schneidkantenlänge über alle Durchmesser
- Helixschneidkante für geringe Schnittkräfte
- Schwingungsdämpfendes Konzept für hohe Auskraglängen in Kombination mit VHM-Verlängerungen
- Reduktion der Bearbeitungskosten durch stufenloses Schulterfräsen
- Hohe Zerspanungsraten auch auf leistungsschwachen Maschinen

Besondere Merkmale: Fräsen HFC

- Sehr hohe Zerspanungsraten bei guter Prozesssicherheit
- Leichter Schnitt auch in Vollnuten
- Funktionstauglichkeit der beiden Schneidkanten auch bei der Bearbeitung im "Spanbecken" zu 100 % sichergestellt
- Optimale Schnittkraftverteilung durch spezielle Schneidkanten geometrie
- Kleine Durchmesser mit hoher Zähnezahl

Special features: Milling 90°

- Multifunctional tool system for highest productivity
- 1 basic body for 2 machining methods = multifunctional
- Facilitation of storage and tool purchase through less articles
- Exact 90° shoulder up to 1/2 cutting edge length on all diameters
- Helix cutting edge for small cutting forces
- Vibration damping concept for big blade overhang in combination with solid carbide extensions
- Reduction of machining costs due to stepless shoulder milling
- High cutting rates also on inefficient machines

Special features: Milling HFC

- High cutting rates with good process security
- Smooth cut also in slot milling
- Functionality of both cutting edges guaranteed to 100 % also on machining in the „chip tank“
- Optimal distribution of cutting forces due to special cutting edge geometry
- Small diameter with many teeth

90° Fräsparameter 90° Milling parameter

WSP Geometrie Insert geometry	LP.. 06		LD.. 10		LD.. 18	
	Schnitttiefe* Cutting depth* [mm] APMX	Vorschub* Feed* [mm] f _z	Schnitttiefe* Cutting depth* [mm] APMX	Vorschub* Feed* [mm] f _z	Schnitttiefe* Cutting depth* [mm] APMX	Vorschub* Feed* [mm] f _z
MP	0,5 2,0 5,2	0,1 0,13 0,17	1,0 3,0 9,0	0,1 0,18 0,25	1,0 6,0 17,0	0,1 0,19 0,25
MM	0,5 2,0 5,2	0,08 0,10 0,15	1,0 3,0 9,0	0,1 0,15 0,20	1,0 6,0 17,0	0,1 0,15 0,22
MK	-	-	1,0 3,0 9,0	0,15 0,20 0,27	1,0 6,0 17,0	0,15 0,21 0,26
MN	-	-	1,0 3,0 9,0	0,1 0,14 0,26	1,0 6,0 17,0	0,1 0,14 0,26
MS	-	-	1,0 3,0 9,0	0,1 0,15 0,20	-	-
MH	0,3 2,0 5,2	0,08 0,10 0,15	-	-	-	-
RP	-	-	-	-	1,0 6,0 17,0	0,15 0,22 0,28
RK	-	-	-	-	1,0 6,0 17,0	0,15 0,24 0,30

HFC Hochvorschub Fräsparameter HFC High feed cutting parameter

WSP Geometrie Insert geometry	LP.. 06		LD.. 10	
	Schnitttiefe* Cutting depth* [mm] APMX	Vorschub* Feed* [mm] f _z	Schnitttiefe* Cutting depth* [mm] APMX	Vorschub* Feed* [mm] f _z
MPH	0,2 0,4 0,7	0,2 0,5 0,8	0,4 0,9 1,4	0,6 1,0 1,5
MMH	0,2 0,4 0,7	0,2 0,4 0,7	0,4 0,9 1,4	0,5 0,9 1,3
MKH	-	-	0,4 0,9 1,4	0,6 1,2 1,5
MHH	0,2 0,4 0,7	0,2 0,5 0,8	0,4 0,9 1,4	0,6 1,2 1,5

Schnittwertempfehlungen siehe Seite 130
Cutting data recommendations page 130

* Angegebene Schnittdaten sind als Richtwert zu sehen, welche durch Versuche für jeden Anwendungsfall separat optimiert werden können.
* Recommended cutting data has to be seen as a reference which can be optimised for each application through trials separately.

BETAtec 90P Feed

Multifunktional Multifunctional

www.boehlerit.com

HFC Eintauchwinkel
HFC Ramping angle



Durchmesser Fräser Diameter Milling cutter	Eintauchwinkel HFC-Fräser Ramping angle HFC milling cutter LP.. 06	Eintauchwinkel HFC-Fräser Ramping angle HFC milling cutter LD.. 10
Ø 10	4,0°	-
Ø 12	2,86°	-
Ø 16	1,43°	8,8°
Ø 18	-	7,3°
Ø 20	1,15°	6,1°
Ø 25	0,92°	4,4°
Ø 32	0,72°	3,2°
Ø 40	0,57°	2,4°
Ø 50	0,46°	1,9°
Ø 63	-	1,4°
Ø 80	-	1,1°

90° Eintauchwinkel
90° Ramping angle



Durchmesser Fräser Diameter Milling cutter	Eintauchwinkel 90°-Fräser Ramping angle 90° milling cutter LP.. 06	Eintauchwinkel 90°-Fräser Ramping angle 90° milling cutter LD.. 10	Eintauchwinkel 90°-Fräser Ramping angle 90° milling cutter LD.. 18
Ø 10	4,57°	-	-
Ø 12	3,81°	-	-
Ø 16	2,86°	18,0°	-
Ø 18	-	15,5°	-
Ø 20	2,29°	12,2°	-
Ø 25	1,83°	8,7°	7,9°
Ø 32	1,43°	6,2°	6,2°
Ø 40	1,15°	4,6°	5,0°
Ø 50	0,92°	3,5°	4,0°
Ø 52	-	-	3,8°
Ø 63	-	2,7°	3,2°
Ø 66	-	-	2,9°
Ø 80	-	2,1°	2,5°
Ø 100	-	-	2,0°
Ø 125	-	-	1,6°
Ø 160	-	-	1,2°

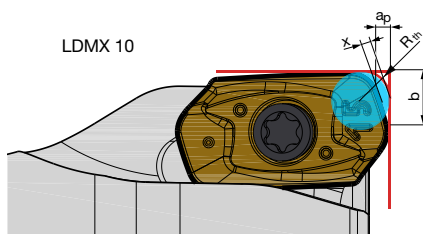

Größe WSP Insert size	Abmessungen [mm] Dimensions [mm]		
L.M..	R _{th}	x	b
6	1,2	0,2	1,4
10	2,2	0,4	3,52

Schnittwertempfehlungen siehe Seite 130
Cutting data recommendations page 130

Aufsteckfräser 90° / LP.. 06 Face milling cutter 90° / LP.. 06

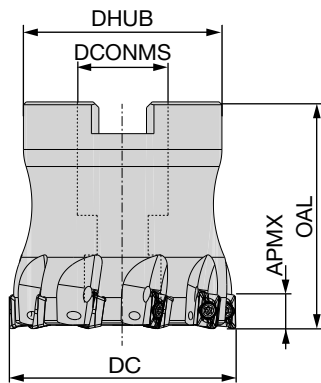

Abmessungen [mm] Dimensions [mm]							Artikelbezeichnung Item code	Bestell-Nr. Ordering No.	Verfügbarkeit Availability	Ersatzteile Spare parts	
DC	DCONMS	DHUB	OAL	APMX 90°	APMX HFC	ZEFF☼					
32	16	25	40	5,2	0,7	8	BF90 LP06.032 Z08	5148557	●		
40	16	35	40	5,2	0,7	10	BF90 LP06.040 Z10	5148558	●		
50	22	43	40	5,2	0,7	11	BF90 LP06.050 Z11	5148559	●		

Schaftfräser 90° / LP.. 06 End milling cutter 90° / LP.. 06

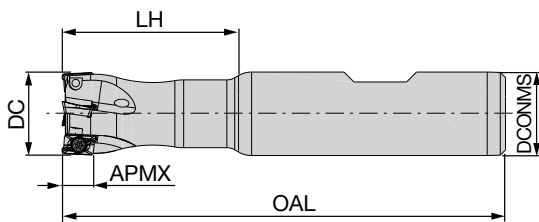

Abmessungen [mm] Dimensions [mm]							Artikelbezeichnung Item code	Schaft Shank	Bestell-Nr. Ordering No.	Verfügbarkeit Availability	Ersatzteile Spare parts	
DC	DCONMS	LH	OAL	APMX 90°	APMX HFC	ZEFF☼						
10	10	28	80	5,2	0,7	2	BE90 LP06.010 Z02	HA	5148548	●		
12	12	30	80	5,2	0,7	3	BE90 LP06.012 Z03	HA	5148550	●		
16	16	35	85	5,2	0,7	4	BE90 LP06.016 Z04	HB	5148552	●		
20	20	40	90	5,2	0,7	5	BE90 LP06.020 Z05	HB	5148554	●		
25	25	50	106	5,2	0,7	7	BE90 LP06.025 Z07	HB	5148555	●		

- Verfügbar ab Lager Available from stock
- ☼ kurzfristig lieferbar available at short notice
- Lieferzeit auf Anfrage Delivery time on request

Bestellbeispiel Order example: 1 Stück piece 5148557 oder or BF90 LP06.032 Z08

BETatec 90P Feed

Systemgröße 06 System size 06

www.boehlerit.com

Einschraubfräser 90° / LP. 06 Screw on type 90° / LP.. 06

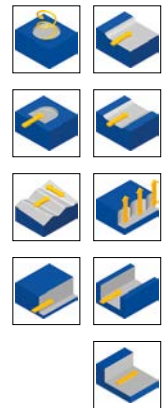
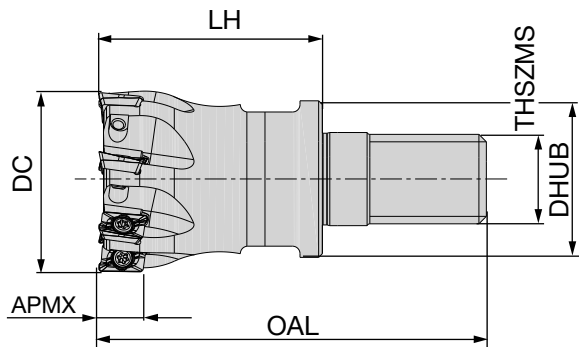

Abmessungen [mm] Dimensions [mm]								Artikelbezeichnung Item code	Bestell-Nr. Ordering No.	Verfügbarkeit Availability	Ersatzteile Spare parts	
DC	DHUB	LH	OAL	APMX 90°	APMX HFC	THSZMS	ZEFF [☆]					
10	9,8	15,5	30,5	5,2	0,7	M6	2	BS90 LP06.010 Z02 M6	5148560	●	 	
12	9,8	15,5	30,5	5,2	0,7	M8	2	BS90 LP06.012 Z02 M8	5224601	○		
12	9,8	15,5	30,5	5,2	0,7	M6	3	BS90 LP06.012 Z03 M6	5148561	●		
16	13,8	20,5	38,5	5,2	0,7	M8	3	BS90 LP06.016 Z03 M8	5224602	○		
16	13,8	20,5	38,5	5,2	0,7	M8	4	BS90 LP06.016 Z04 M8	5148562	●		
20	18	27	46	5,2	0,7	M10	5	BS90 LP06.020 Z05 M10	5148563	●		
25	21	30	52	5,2	0,7	M12	7	BS90 LP06.025 Z07 M12	5148564	●		
32	29	43	66	5,2	0,7	M16	8	BS90 LP06.032 Z08 M16	5148556	●		

Einschraubfräser 90° / LP. 06 / INCH Screw on type 90° / LP.. 06 / INCH

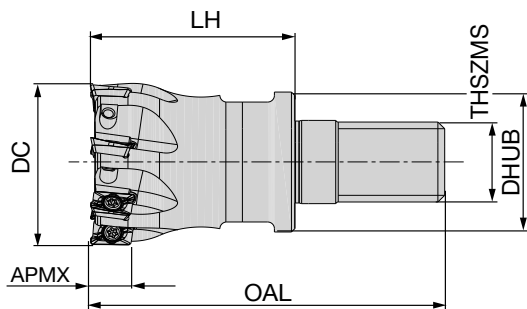

Abmessungen [INCH] Dimensions [INCH]								Artikelbezeichnung Item code	Bestell-Nr. Ordering No.	Verfügbarkeit Availability	Ersatzteile Spare parts	
DC	DHUB	LH	OAL	APMX 90°	APMX HFC	THSZMS	ZEFF [☆]					
0.75	0.71	1.06	1.81	0.204	0.027	M10	5	BSU90 LP06.0750 Z05 M10	5156795	○	 	
1.00	0.83	1.18	2.05	0.204	0.027	M12	7	BSU90 LP06.1000 Z07 M12	5156797	○		

Bestellbeispiel Order example: 1 Stück piece 5148560 oder or BS90 LP06.010 Z02 M6

Die passenden Hartmetallverlängerungen finden Sie ab Seite 294

You will find the matching carbide extensions from page 294

CEDC = Anzahl der Schneidkanten CEDC = Number of cutting edges	Artikelbezeichnung Item code	Schneidstoffsorte Cutting materials	Bestell-Nr. Ordering No.	Verfügbarkeit Availability	Abmessungen [mm] Dimensions [mm]					
					L	LE	IC	S	D1	RE
<p>CEDC = 2</p>	90° Platten/90° inserts									
	LPMX 060204-MP	BCP25M	5149998	●	6	-	3,64	2,15	2,05	0,4
	LPMX 060204-MP	BCP35M	5150000	●	6	-	3,64	2,15	2,05	0,4
	LPMX 060204-MM	BCM35M	5150001	●	6	-	3,64	2,15	2,05	0,4
	LPMX 060220-MH	BCH10M	5168674	●	6	-	3,64	2,15	2,05	2,0
	LPMX 060220-MH	BCH30M	5168675	●	6	-	3,64	2,15	2,05	2,0
<p>CEDC = 2</p>	HFC Platten/HFC insert									
	LPMX 060210-MPH	BCP20M	5150004	●	-	0,7	3,64	2,15	2,05	1
	LPMX 060210-MPH	BCP25M	5150006	●	-	0,7	3,64	2,15	2,05	1
	LPMX 060210-MMH	BCM35M	5150007	●	-	0,7	3,64	2,15	2,05	1
	LPMX 060210-MHH	BCH05M	5150009	○	-	0,7	3,64	2,15	2,05	1
	LPMX 060210-MHH	BCH10M	5150010	●	-	0,7	3,64	2,15	2,05	1
	LPMX 060210 MMH	BCS35M	5212100	●		0,7	3,64	2,15	2,05	1

BETAtec 90P Feed

Systemgröße 10 System size 10

www.boehlerit.com

Aufsteckfräser 90° / LD.. 10 Face milling cutter 90° / LD.. 10

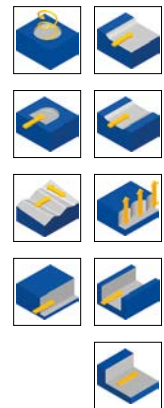
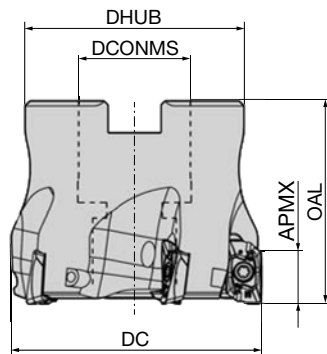

Abmessungen [mm] Dimensions [mm]							Artikelbezeichnung Item code	Bestell-Nr. Ordering No.	Verfügbarkeit Availability	Ersatzteile Spare parts	
DC	DCONMS	DHUB	OAL	APMX 90°	APMX HFC	ZEFF [☆]					
40	16	35	40	9	1,4	4	BF90 LD10.040 Z04	5081757	●	 Spannschraube Fixation screw AP02-25068 5085706 M _A = 2Nm	 Torx- Schlüssel Torque wrench IP8 5088519
40	16	35	40	9	1,4	6	BF90 LD10.040 Z06	5081762	●		
50	22	43	40	9	1,4	5	BF90 LD10.050 Z05	5081765	●		
50	22	43	40	9	1,4	7	BF90 LD10.050 Z07	5081767	●		
63	22	48	40	9	1,4	6	BF90 LD10.063 Z06	5081769	●		
63	22	48	40	9	1,4	8	BF90 LD10.063 Z08	5081770	●		
80	27	60	50	9	1,4	10	BF90 LD10.080 Z10	5081771	●		
100	32	78	50	9	1,4	8	BF90 LD10.100 Z08	5215741	○		

Aufsteckfräser 90° / LD.. 10 / INCH Face milling cutter 90° / LD.. 10 / INCH

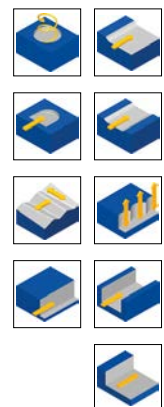
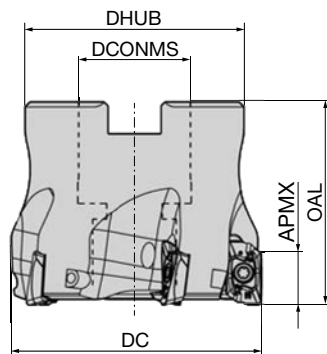

Abmessungen [INCH] Dimensions [INCH]							Artikelbezeichnung Item code	Bestell-Nr. Ordering No.	Verfügbarkeit Availability	Ersatzteile Spare parts	
DC	DCONMS	DHUB	OAL	APMX 90°	APMX HFC	ZEFF [☆]					
1.5	0.75	1.375	1.50	0.354	0.055	4	BFU90 LD10.1500 Z04	5132713	○	 Spannschraube Fixation screw AP02-25068 5085706 M _A = 2Nm	 Torque wrench IP8 5088519
2.0	0.75	1.750	1.50	0.354	0.055	5	BFU90 LD10.2000 Z05	5132714	○		
2.5	1.00	2.250	1.75	0.354	0.055	6	BFU90 LD10.2500 Z06	5132715	○		
3.0	1.00	2.250	2.00	0.354	0.055	8	BFU90 LD10.3000 Z08	5132716	○		

Bestellbeispiel Order example: 1 Stück piece 5081757 oder or BF90 LD10.040 Z04

Schaftfräser 90° / LD.. 10 End milling cutter 90° / LD.. 10

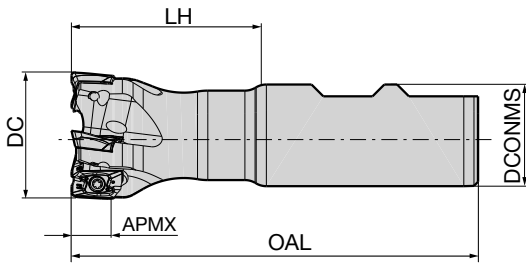

Abmessungen [mm] Dimensions [mm]							Artikelbezeichnung Item code	Schaft Shank	Bestell-Nr. Ordering No.	Verfügbarkeit Availability	Ersatzteile Spare parts	
DC	DCONMS	LH	OAL	APMX 90°	APMX HFC	ZEFF [⊙]					Spann- schraube Fixation screw AP02-25051 5091691 M _A = 2Nm	Torx- Schlüssel Torque wrench IP8 5088519
16	16	37	85	9	1,4	2	BE90 LD10.016 Z02	HB	5081774	●		
18	20	38	90	9	1,4	2	BE90 LD10.018 Z02	HB	5102530	○		
20	20	40	90	9	1,4	2	BE90 LD10.020 Z02	HB	5113590	●		
20	20	90	140	9	1,4	2	BE90 LD10.020 Z02 140	HA	5113591	●		
20	20	40	90	9	1,4	3	BE90 LD10.020 Z03	HB	5081777	●		
25	25	50	106	9	1,4	3	BE90 LD10.025 Z03	HB	5081778	●		
25	25	50	106	9	1,4	4	BE90 LD10.025 Z04	HB	5081779	●		
32	32	64	124	9	1,4	3	BE90 LD10.032 Z03	HB	5081781	●		
32	32	64	124	9	1,4	5	BE90 LD10.032 Z05	HB	5081782	●		

Schaftfräser 90° / LD.. 10 / INCH End milling cutter 90° / LD.. 10 / INCH

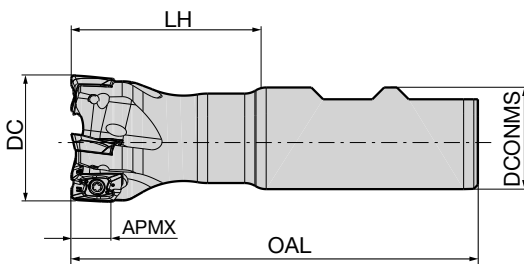

Abmessungen [INCH] Dimensions [INCH]							Artikelbezeichnung Item code	Schaft Shank	Bestell-Nr. Ordering No.	Verfügbarkeit Availability	Ersatzteile Spare parts	
DC	DCONMS	LH	OAL	APMX 90°	APMX HFC	ZEFF [⊙]					Spann- schraube Fixation screw AP02-25051 5091691 M _A = 2Nm	Torque wrench IP8 5088519
0.500	0.625	1.250	3.25	0.354	0.055	1	BEU90 LD10.0500 Z01 325	HB	5132719	○		
0.625	0.625	1.250	3.25	0.354	0.055	2	BEU90 LD10.0625 Z02 325	HB	5132720	○		
0.750	0.750	1.625	3.50	0.354	0.055	2	BEU90 LD10.0750 Z02 350	HB	5132722	○		
1.000	1.000	2.000	4.00	0.354	0.055	3	BEU90 LD10.1000 Z03 400	HB	5132723	○		
1.250	1.000	2.000	4.00	0.354	0.055	3	BEU90 LD10.1250 Z03 400	HB	5132725	○		

Bestellbeispiel Order example: 1 Stück piece 5081774 oder or BE90 LD10.016 Z02

- Verfügbar ab Lager Available from stock
- Lieferzeit auf Anfrage Delivery time on request



BETAtec 90P Feed

Systemgröße 10 System size 10

www.boehlerit.com

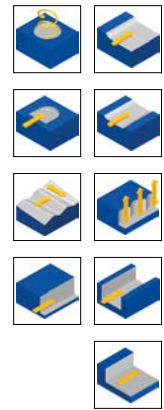
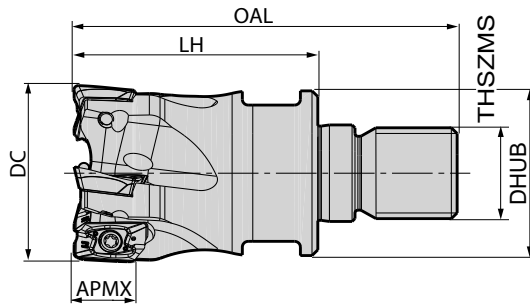
Einschraubfräser 90° / LD.. 10 Screw on type 90° / LD.. 10



Abmessungen [mm] Dimensions [mm]								Artikelbezeichnung Item code	Bestell-Nr. Ordering No.	Verfügbarkeit Availability	Ersatzteile Spare parts	
DC	DHUB	OAL	LH	APMX 90°	APMX HFC	THSZMS	ZEFF [☼]					
16	13,8	49	31	9	1,4	M8	2	BS90 LD10.016 Z02 M8	5081783	●	AP02-25051 5091691 M _A = 2Nm	
20	18	49	30	9	1,4	M10	3	BS90 LD10.020 Z03 M10	5081785	●		
25	21	54	32	9	1,4	M12	3	BS90 LD10.025 Z03 M12	5081788	●		
25	21	54	32	9	1,4	M12	4	BS90 LD10.025 Z04 M12	5081789	●	 Spann- schraube Fixation screw AP02-25068 5085706 M _A = 2Nm	Torx- Schlüssel Torque wrench IP8 5088519
32	29	66	43	9	1,4	M16	3	BS90 LD10.032 Z03 M16	5116746	●		
32	29	66	43	9	1,4	M16	4	BS90 LD10.032 Z04 M16	5224603	○		
32	29	66	43	9	1,4	M16	5	BS90 LD10.032 Z05 M16	5081790	●		
40	29	66	43	9	1,4	M16	6	BS90 LD10.040 Z06 M16	5098310	●		

Bestellbeispiel Order example: 1 Stück piece 5081783 oder or BS90 LD10.016 Z02 M8

Die passenden Hartmetallverlängerungen finden Sie ab Seite 294

You will find the matching carbide extensions from page 294

CEDC = Anzahl der Schneidkanten CEDC = Number of cutting edges	Artikelbezeichnung Item code	Schneidstoffsorte Cutting materials	Bestell-Nr. Ordering No.	Verfügbarkeit Availability	Abmessungen [mm] Dimensions [mm]						
					L	LE	IC	S	D1	RE	
<p>90° Platten/90° inserts</p>	LDMX 100404 SR-MP	BCP25M	5145449	●	10		6,6	4,76	2,8	0,4	
	LDMX 100404 SR-MP	BCP35M	5145447	●	10		6,6	4,76	2,8	0,4	
	LDMX 100404 SR-MM	BCM35M	5145450	●	10		6,6	4,76	2,8	0,4	
	LDMX 100404 SR-MM	BCM40M	5145452	●	10		6,6	4,76	2,8	0,4	
	LDHX 100404 FR-MN	BCN10M	5141477	●	10		6,6	4,76	2,8	0,4	
	LDHX 100404 FR-MN	BWN10M	5141470	●	10		6,6	4,76	2,8	0,4	
	LDMX 100408 SR-MP	BCP25M	5081948	●	10		6,6	4,76	2,8	0,8	
	LDMX 100408 SR-MP	BCP35M	5081947	●	10		6,6	4,76	2,8	0,8	
	LDMX 100408 SR-MP	BCP40M	5092193	●	10		6,6	4,76	2,8	0,8	
	LDMX 100408 SR-MM	BCM35M	5092296	●	10		6,6	4,76	2,8	0,8	
	LDMX 100408 SR-MM	BCM40M	5081950	●	10		6,6	4,76	2,8	0,8	
	LDMX 100408 SR-MK	BCK20M	5081949	●	10		6,6	4,76	2,8	0,8	
	LDHX 100408 FR-MN	BCN10M	5141479	●	10		6,6	4,76	2,8	0,8	
	LDHX 100408 FR-MN	BWN10M	5141478	●	10		6,6	4,76	2,8	0,8	
	LDMX 100408 SR-MS	BCS35M	5125069	●	10		6,6	4,76	2,8	0,8	
	LDMX 100408 SR-MS	BCS40M	5168099	●	10		6,6	4,76	2,8	0,8	
	LDMX 100420 SR-MP	BCP25M	5103996	●	10		6,6	4,76	2,8	2	
	LDMX 100420 SR-MP	BCP35M	5103994	●	10		6,6	4,76	2,8	2	
	LDMX 100430 SR-MP	BCP25M	5104003	●	10		6,6	4,76	2,8	3	
	LDMX 100430 SR-MP	BCP35M	5103998	●	10		6,6	4,76	2,8	3	
CEDC = 2											
<p>HFC Platten/HFC insert</p>	LDMX 100415 SR-MPH	BCP20M	5092202	●		1,5	6,6	4,76	2,8	1,5	
	LDMX 100415 SR-MPH	BCP25M	5081952	●		1,5	6,6	4,76	2,8	1,5	
	LDMX 100415 SR-MPH	BCP30M	5092201	●		1,5	6,6	4,76	2,8	1,5	
	LDMX 100415 SR-MPH	BCP35M	5081951	●		1,5	6,6	4,76	2,8	1,5	
	LDMX 100415 SR-MMH	BCM35M	5092304	●		1,5	6,6	4,76	2,8	1,5	
	LDMX 100415 SR-MMH	BCM40M	5081954	●		1,5	6,6	4,76	2,8	1,5	
	LDMX 100415 SR-MKH	BCK15M	5092210	●		1,5	6,6	4,76	2,8	1,5	
	LDMX 100415 SR-MKH	BCK20M	5092208	●		1,5	6,6	4,76	2,8	1,5	
	LDMX 100415 SR-MHH	BCH05M	5145436	○		1,5	6,6	4,76	2,8	1,5	
	LDMX 100415 SR-MHH	BCH10M	5145445	●		1,5	6,6	4,76	2,8	1,5	
	CEDC = 2										

BETAtec 90P Feed

Systemgröße 18 System size 18

www.boehlerit.com

Aufsteckfräser 90° / LD.. 18 Face milling cutter 90° / LD.. 18

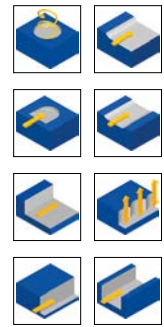
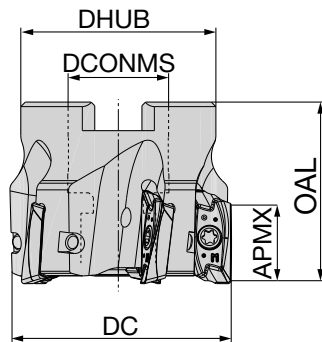

Abmessungen [mm] Dimensions [mm]						Artikelbezeichnung Item code	Bestell-Nr. Ordering No.	Verfügbarkeit Availability	Ersatzteile Spare parts	
DC	DCONMS	DHUB	OAL	APMX	ZEFF [☆]				Spann- schraube Fixation screw AP02-35100 5092669 MA = 3Nm	Torx- Schlüssel Torque wrench IP15 5088520
40	16	35	40	17	4	BF90 LD18.040 Z04	5107337	●		
50	22	43	40	17	5	BF90 LD18.050 Z05	5107338	●		
52	22	43	40	17	5	BF90 LD18.052 Z05	5107339	○		
63	22	48	40	17	5	BF90 LD18.063 Z05	5107340	●		
63	22	48	40	17	6	BF90 LD18.063 Z06	5107342	○		
66	22	48	40	17	6	BF90 LD18.066 Z06	5107343	○		
80	27	60	50	17	7	BF90 LD18.080 Z07	5107344	●		
100	32	78	50	17	7	BF90 LD18.100 Z07	5152389	●		
100	32	78	50	17	8	BF90 LD18.100 Z08	5107345	●		
125	40	90	60	17	7	BF90 LD18.125 Z07	5176245	●		
125	40	90	60	17	9	BF90 LD18.125 Z09	5107347	○		
160	40	115	60	17	10	BF90 LD18.160 Z10 NC	5107349	●		

Aufsteckfräser 90° / LD.. 18 / INCH Face milling cutter 90° / LD.. 18 / INCH

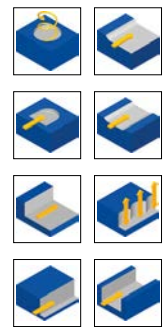
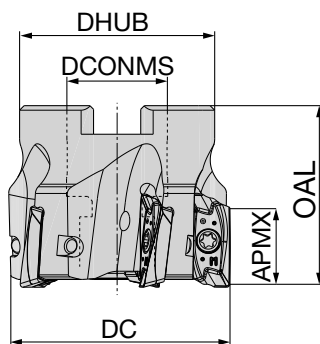

Abmessungen [INCH] Dimensions [INCH]						Artikelbezeichnung Item code	Bestell-Nr. Ordering No.	Verfügbarkeit Availability	Ersatzteile Spare parts	
DC	DCONMS	DHUB	OAL	APMX	ZEFF [☆]				Spann- schraube Fixation screw AP02-35100 5092669 M _A = 3Nm	Torx- Schlüssel Torque wrench IP15 5088520
2.0	0.75	1.750	1.75	0.670	4	BFU90 LD18.2000 Z04	5132734	○		
2.5	1.00	2.250	1.75	0.670	5	BFU90 LD18.2500 Z05	5132735	○		
3.0	1.00	2.250	1.75	0.670	7	BFU90 LD18.3000 Z07	5132736	○		
4.0	1.50	3.750	2.25	0.670	8	BFU90 LD18.4000 Z08	5132737	○		
5.0	1.50	3.750	2.50	0.670	9	BFU90 LD18.5000 Z09	5132738	○		

Bestellbeispiel Order example: 1 Stück piece 5107337 oder or BF90 LD18.040 Z04

Schaftfräser 90° / LD.. 18

End milling cutter 90° / LD.. 18

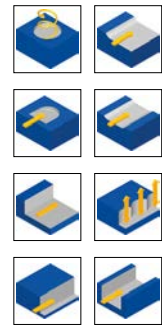
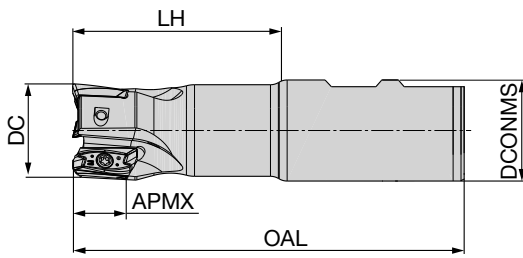

Abmessungen [mm]		Dimensions [mm]				Artikelbezeichnung Item code	Schaft Shank	Bestell-Nr. Ordering No.	Verfügbarkeit Availability	Ersatzteile Spare parts	
DC	DCONMS	LH	OAL	APMX	ZEFF \diamond					Spannschraube Fixation screw AP02-35100 5092669 MA = 3Nm	Torx-Schlüssel Torque wrench IP15 5088520
25	25	50	106	17	2	BE90 LD18.025 Z02	HB	5107350	●		
32	32	64	124	17	3	BE90 LD18.032 Z03	HB	5107351	●		
40	32	65	124	17	4	BE90 LD18.040 Z04	HB	5107352	●		

Schaftfräser 90° / LD.. 18 / INCH

End milling cutter 90° / LD.. 18 / INCH

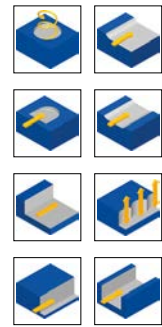
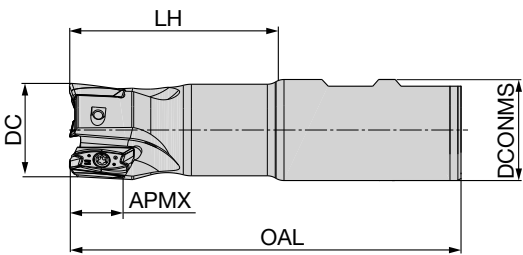

Abmessungen [INCH]		Dimensions [INCH]				Artikelbezeichnung Item code	Schaft Shank	Bestell-Nr. Ordering No.	Verfügbarkeit Availability	Ersatzteile Spare parts	
DC	DCONMS	LH	OAL	APMX	ZEFF \diamond					Spannschraube Fixation screw AP02-35100 5092669 MA = 3Nm	Torx-Schlüssel Torque wrench IP15 5088520
1.00	1.00	2.00	4.0	0.670	2	BEU90 LD18.1000 Z02	HB	5132739	○		
1.25	1.00	2.25	4.5	0.670	3	BEU90 LD18.1250 Z03	HB	5132740	○		
1.50	1.25	2.25	4.5	0.670	4	BEU90 LD18.1500 Z04	HB	5132741	○		

Bestellbeispiel Order example: 1 Stück piece 5107350 oder or BE90 LD18.025 Z02

● Verfügbar ab Lager Available from stock
○ Lieferzeit auf Anfrage Delivery time on request

BETatec 90P Feed

Systemgröße 18 System size 18

www.boehlerit.com

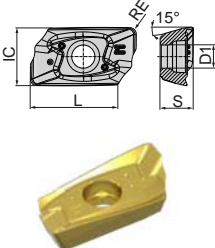
CEDC = Anzahl der Schneidkanten CEDC = Number of cutting edges	Artikelbezeichnung Item code	Schneidstoffsorte Cutting materials	Bestell-Nr. Ordering No.	Verfügbarkeit Availability	Abmessungen [mm] Dimensions [mm]					
					L	IC	S	D1	RE	
	90° Platten/90° inserts									
	LDMX 180508 SR-MP	BCP25M	5104006	●	18	9,65	5	4,15	0,8	
	LDMX 180508 SR-MP	BCP35M	5104004	●	18	9,65	5	4,15	0,8	
	LDMX 180508 SR-MP	BCP40M	5104078	●	18	9,65	5	4,15	0,8	
	LDMX 180508 SR-MM	BCM35M	5104007	●	18	9,65	5	4,15	0,8	
	LDMX 180508 SR-MM	BCM40M	5104012	●	18	9,65	5	4,15	0,8	
	LDMX 180508 SR-MK	BCK20M	5104008	●	18	9,65	5	4,15	0,8	
	LDGX 180508 FR-MN	BCN10M	5104010	●	18	9,65	5	4,15	0,8	
	LDGX 180508 FR-MN	BWN10M	5104009	●	18	9,65	5	4,15	0,8	
		LDMX 180512 SR-RP	BCP25M	5107507	●	18	9,65	5	4,15	1,2
		LDMX 180512 SR-RP	BCP35M	5107508	●	18	9,65	5	4,15	1,2
		LDMX 180512 SR-RP	BCP40M	5107510	●	18	9,65	5	4,15	1,2
		LDMX 180512 SR-MM	BCM35M	5145425	●	18	9,65	5	4,15	1,2
		LDMX 180512 SR-MM	BCM40M	5145427	●	18	9,65	5	4,15	1,2
		LDMX 180512 SR-RK	BCK20M	5107511	●	18	9,65	5	4,15	1,2
		LDMX 180516 SR-RP	BCP25M	5151254	●	18	9,65	5	4,15	1,6
		LDMX 180516 SR-RP	BCP35M	5151255	●	18	9,65	5	4,15	1,6
		LDMX 180516 SR-MM	BCM35M	5151154	●	18	9,65	5	4,15	1,6
	LDMX 180516 SR-MM	BCM40M	5151157	●	18	9,65	5	4,15	1,6	

CEDC = 2

- Verfügbar ab Lager Available from stock
- Lieferzeit auf Anfrage Delivery time on request

Bestellbeispiel Order example: 10 Stück pieces 5104006 oder or LDMX 180508 SR-MP BCP25M

	Aufsteckfräser 90° Face milling cutter 90°	Schaftfräser 90° End milling cutter 90°	Einschraubfräser 90° Screw on type 90°
Ausführung Execution			
Durchmesserbereich metrisch Diameter range metric	Ø 40 - 200 mm	Ø 16 - 35 mm	Ø 16 - 40 mm
Durchmesserbereich inch Diameter range inch	Ø 2" - 8"	Ø 3/4" - 1 1/4"	Ø 1"
Plattengröße Insert size	SD...06, SD..10, SD..14, SD..18	SD..06, SD..10	SD..06, SD..10

Besondere Merkmale: Fräsen HFC

- Multifunktionales Werkzeugsystem für höchste Produktivität
- 1 Grundkörper für 2 Bearbeitungsverfahren = multifunktional
- Erleichterung der Lagerhaltung und der Werkzeugbeschaffung durch weniger Artikel
- 4 real einsetzbare Schneiden
- Leichter Schnitt auch in Vollnuten durch perfekt abgestimmte Fräsgeometrie
- Optimale Aufnahme der axialen Schnittkräfte durch spezielle Anordnung von Radien an der Schneidkante
- Höchste Zahnvorschübe (bis $f_z = 3,0$ mm bei SDMT 18)
- Einschraubfräser in Kombination mit den VHM-Verlängerungen minimieren Schwingungen bei Auskragungen bis 300 mm
- Hohe Zerspanungsvolumina auch bei kleinem Werkzeugdurchmesser

Besondere Merkmale: Fräsen 90°

- Exakte 90° bei 4 Schneiden bis ca. 1/2 Schneidkantenlänge über alle Durchmesser
- Leichter Schnitt durch positive Grundgeometrie
- Ungleichteilung führt zu Schwingungsreduktion und extremer Laufruhe
- Maximale Produktivitätssteigerung durch hohes Zerspanvolumen je Schneide
- Prozesssicherheit durch gutes Verschleißverhalten und Stabilisierung der Schneidkante aufgrund spezieller Plattengeometrien

Special features: Milling HFC

- Multifunctional tool system for highest productivity
- 1 basic body for 2 machining operations = multifunctional
- Facilitation of storage and tool purchase through less articles
- 4 real usable cutting edges
- Smooth cut also on full groove due to perfect coordinated milling geometry
- Optimal consumption of the axial cutting forces due to special layout of the radii on the cutting edge
- Highest tooth feed (up to $f_z = 3.0$ mm with SDMT 18)
- Screw on type milling cutter in combination with solid carbide extensions minimize vibrations on overhangs up to 300 mm
- High cutting volume also on small tool diameter

Special features: Milling 90°

- Exactly 90° on 4 cutting edges up to 1/2 cutting edge length on all diameter
- Smooth cut due to positive basic geometry
- Unequal division leads to reduction of vibration and extremely smooth running
- Maximum productivity increase due to high metal removal per cutting edge
- Process security due to non problematic wear behaviour and stabilisation of the cutting edge through special insert geometry

HFC Hochvorschub Fräsparameter

HFC High feed cutting milling parameter

WSP Geometrie Insert geometry	SD.. 06		SD.. 10		SD.. 14		SD.. 18	
	Schnitttiefe* Cutting depth* [mm] APMX max	Vorschub* Feed* [mm] f _z	Schnitttiefe* Cutting depth* [mm] APMX max	Vorschub* Feed* [mm] f _z	Schnitttiefe* Cutting depth* [mm] APMX max	Vorschub* Feed* [mm] f _z	Schnitttiefe* Cutting depth* [mm] APMX max	Vorschub* Feed* [mm] f _z
	MPH	0,3 0,5 1,0	0,4 0,6 1,1	0,5 0,8 1,3	0,6 1,0 1,4	0,6 1,2 2,2	0,7 1,4 2,2	1,0 2,2 3,2
MMH	0,3 0,5 1,0	0,3 0,5 1,0	0,5 0,8 1,3	0,5 0,9 1,4	0,6 1,2 2,2	0,8 1,2 2,2	1,0 2,0 3,0	1,0 1,6 2,5
MSH	0,3 0,5 1,0	0,3 0,5 0,9	0,5 0,7 1,2	0,5 0,7 1,2	0,6 1,2 2,0	0,6 1,2 2,2	1,0 2,0 3,0	1,0 1,5 2,5
MTH	-	-	0,5 0,7 1,2	0,5 0,7 1,2	-	-	-	-
MHH	0,3 0,5 1,0	0,4 0,6 1,1	0,5 0,8 1,3	0,6 1,0 1,4	0,4 1,2 2,2	0,4 1,2 2,2	-	-
RPH	-	-	0,5 1,0 1,5	0,7 1,1 1,6	0,7 1,5 2,4	0,8 1,6 2,4	1,0 2,5 3,5	1,4 2,2 3,0
RKH	-	-	0,5 1,0 1,5	0,7 1,2 1,6	0,7 1,6 2,4	0,8 1,7 2,4	1,0 2,8 3,5	1,4 2,5 3,0
RHH	-	-	0,4 0,8 1,2	0,4 1,1 1,6	0,5 1,5 2,4	0,5 1,6 2,4	1,0 2,2 3,5	0,8 1,8 2,8

90° Fräsparameter

90° Milling parameter

WSP Geometrie Insert geometry	SD.. 10		SD.. 14	
	Schnitttiefe* Cutting depth* [mm] APMX max	Vorschub* Feed* [mm] f _z	Schnitttiefe* Cutting depth* [mm] APMX max	Vorschub* Feed* [mm] f _z
	MP	0,8 3,0 9,0	0,10 0,18 0,23	1,2 6,0 12,5
MM	0,8 3,0 9,0	0,08 0,14 0,2	1,2 6,0 12,5	0,1 0,15 0,22
MK	0,8 3,0 9,0	0,10 0,2 0,26	1,2 6,0 12,5	0,1 0,22 0,28
MN	0,8 5,0 9,0	0,05 0,12 0,20	1,2 8,0 12,5	0,06 0,14 0,22

Schnittwertempfehlungen siehe Seite 130
Cutting data recommendations page 130

* Angegebene Schnittdaten sind als Richtwert zu sehen, welche durch Versuche für jeden Anwendungsfall separat optimiert werden können.
* Recommended cutting data has to be seen as a reference which can be optimised for each application through trials separately.

HFC Eintauchwinkel HFC Ramping angle



Durchmesser Fräser Diameter Milling cutter	Eintauchwinkel HFC-Fräser α max. Ramping angle HFC milling cutter α max. SD.. 06	Eintauchwinkel HFC-Fräser α max. Ramping angle HFC milling cutter α max. SD.. 10	Eintauchwinkel HFC-Fräser α max. Ramping angle HFC milling cutter α max. SD.. 14	Eintauchwinkel HFC-Fräser α max. Ramping angle HFC milling cutter α max. SD.. 18
Ø 16	9°	-	-	-
Ø 20	4,8°	-	-	-
Ø 25	3°	4,4°	-	-
Ø 32	2°	2,9°	-	-
Ø 35	1,7°	-	-	-
Ø 36	-	2,3°	-	-
Ø 40	-	2,0°	-	-
Ø 42	-	1,9°	-	-
Ø 50	-	1,5°	2,4°	-
Ø 52	-	1,3°	2,2°	-
Ø 63	-	1,1°	1,7°	3,0°
Ø 66	-	1,0°	1,5°	-
Ø 80	-	0,8°	1,3°	2,5°
Ø 100	-	0,7°	1,0°	2,0°
Ø 125	-	0,5°	0,7°	1,6°
Ø 160	-	-	-	1,3°
Ø 200	-	-	-	1,0°

90° Eintauchwinkel 90° Ramping angle



Durchmesser Fräser Diameter Milling cutter	Eintauchwinkel 90°-Fräser α max. Ramping angle 90° milling cutter α max. SD.. 10	Eintauchwinkel 90°-Fräser α max. Ramping angle 90° milling cutter α max. SD.. 14
Ø 25	7,0°	-
Ø 32	4,6°	-
Ø 36	4,0°	-
Ø 40	3,3°	-
Ø 42	3,0°	-
Ø 50	2,4°	5,5°
Ø 52	2,2°	5,3°
Ø 63	1,8°	3,7°
Ø 66	1,6°	3,4°
Ø 80	1,3°	2,6°
Ø 100	1,0°	1,9°
Ø 125	0,8°	1,5°
Ø 160	0,5°	-

Größe WSP Insert size	Abmessungen [mm] Dimensions [mm]		
SD..	R _{th}	x	b
06	1,77	0,45	5,12
10	2,25	0,62	8,033
14	3,45	0,93	10,868
18	4,82	1,24	13,77

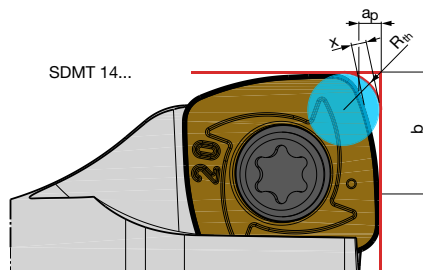



DELTAtec 90P Feed

Systemgröße 06 System size 06

www.boehlerit.com

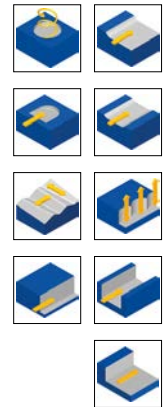
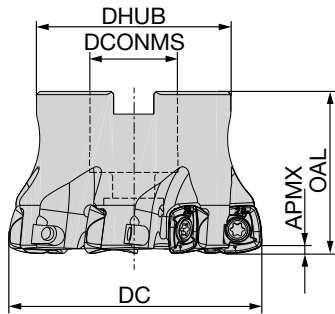

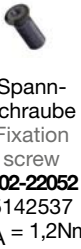
Aufsteckfräser 90° / SD.. 06 Face milling cutter 90° / SD.. 06

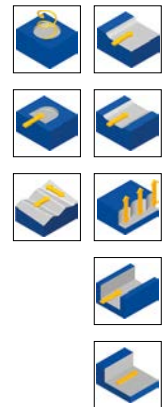
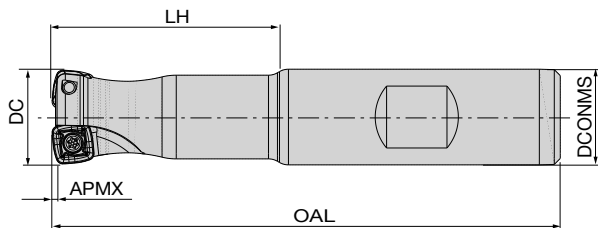

Abmessungen [mm] Dimensions [mm]						Artikelbezeichnung Item code	Bestell-Nr. Ordering No.	Verfügbarkeit Availability	Ersatzteile Spare parts	
DC	DCONMS	DHUB	OAL	APMX HFC	ZEFF [⊙]					
40	16	35	40	1	6	BF90 SD06.040 Z06	5224605	○		
42	16	35	40	1	6	BF90 SD06.042 Z06	5224606	○		
50	22	43	40	1	7	BF90 SD06.050 Z07	5224607	○		
52	22	43	40	1	7	BF90 SD06.052 Z07	5224609	○		
									 	

Schafffräser 90° / SD.. 06 End milling cutter 90° / SD.. 06

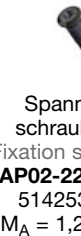

Abmessungen [mm] Dimensions [mm]						Artikelbezeichnung Item code	Schaft Shank	Bestell-Nr. Ordering No.	Verfügbarkeit Availability	Ersatzteile Spare parts	
DC	DCONMS	LH	OAL	APMX HFC	ZEFF [⊙]						
16	16	37	85	1	2	BE90 SD06.016 Z02	HB	5120323	●		
20	20	40	90	1	3	BE90 SD06.020 Z03	HB	5142941	●		
25	25	50	106	1	4	BE90 SD06.025 Z04	HB	5120322	●		
32	32	64	124	1	5	BE90 SD06.032 Z05	HB	5142942	●		
35	32	64	124	1	5	BE90 SD06.035 Z05	HB	5142943	●		
										 	

Bestellbeispiel Order example: 1 Stück piece 5224605 oder or BF90 SD06.040 Z06

Schaftfräser 90° / SD.. 06 / INCH

End milling cutter 90° / SD.. 06 / INCH

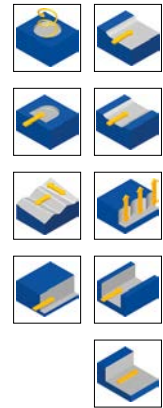
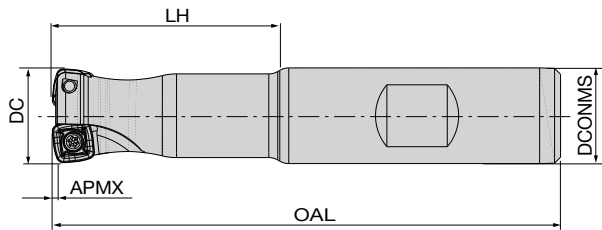

Abmessungen [INCH] Dimensions [INCH]							Artikelbezeichnung Item code	Schaft Shank	Bestell-Nr. Ordering No.	Verfügbarkeit Availability	Ersatzteile Spare parts	
DC	DCONMS	LH	OAL	APMX HFC	ZEFF							
0.75	0.75	1.5	3.375	0.039	3	BEU90 SD06.0750 Z03	HB	5156780	○	 Spannschraube Fixation screw AP02-22052 5142537 M _A = 1,2Nm	 Torx-Schlüssel Torque wrench IP7 5118123	
1.00	1.00	2	4	0.039	4	BEU90 SD06.1000 Z04	HB	5156782	○			
1.25	1.00	2	4	0.039	5	BEU90 SD06.1250 Z05	HB	5156786	○			

Einschraubfräser 90° / SD.. 06

Screw on type 90° / SD.. 06

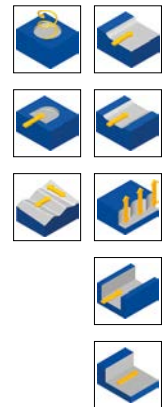
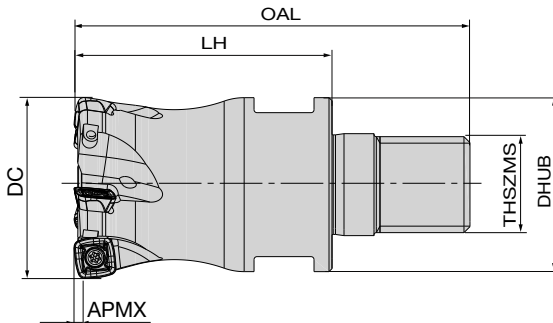

Abmessungen [mm] Dimensions [mm]							Artikelbezeichnung Item code	Bestell-Nr. Ordering No.	Verfügbarkeit Availability	Ersatzteile Spare parts	
DC	DHUB	LH	OAL	THSZMS	APMX HFC	ZEFF					
16	13,8	31	49	M8	1	2	BS90 SD06.016 Z02 M8	5142945	●	 Spannschraube Fixation screw AP02-22052 5142537 M _A = 1,2Nm	 Torx-Schlüssel Torque wrench IP7 5118123
20	18	29,8	48,8	M10	1	3	BS90 SD06.020 Z03 M10	5142946	●		
25	21	32	54	M12	1	4	BS90 SD06.025 Z04 M12	5142947	●		
32	29	43	66	M16	1	5	BS90 SD06.032 Z05 M16	5142949	●		
35	29	43	66	M16	1	5	BS90 SD06.035 Z05 M16	5142950	●		

Bestellbeispiel Order example: 1 Stück piece 5156780 oder or BEU90 SD06.0750 Z03

Die passenden Hartmetallverlängerungen finden Sie ab Seite 294
You will find the matching carbide extensions from page 294

- Verfügbar ab Lager Available from stock
- ⦿ kurzfristig lieferbar available at short notice
- Lieferzeit auf Anfrage Delivery time on request



DELTAtec 90P Feed

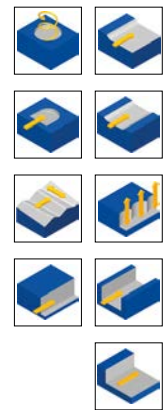
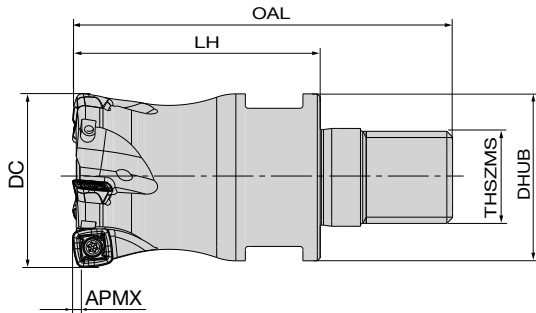

Systemgröße 06 System size 06

www.boehlerit.com

Einschraubfräser 90° / SD.. 06 / INCH Screw on type 90° / SD.. 06 / INCH

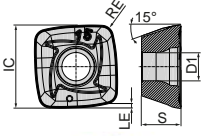

Abmessungen [INCH] Dimensions [INCH]							Artikelbezeichnung Item code	Bestell-Nr. Ordering No.	Verfügbarkeit Availability	Ersatzteile Spare parts	
DC	DHUB	LH	OAL	THSZMS	APMX HFC	ZEFF					
1.00	0.827	1.26	2.125	M12	0.039	4	BSU90 SD06.1000 Z04 M12	5156789	○		
										Spann- schraube Fixation screw AP02-22052 5142537 M _A = 1,2Nm	Torx- Schlüssel Torque wrench IP7 5118123

CEDC = Anzahl der Schneidkanten CEDC = Number of cutting edges	Artikelbezeichnung Item code	Schneidstoffsorte Cutting materials	Bestell-Nr. Ordering No.	Verfügbarkeit Availability	Abmessungen [mm] Dimensions [mm]					
					LE	IC	S	D1	RE	
  CEDC = 4	HFC Platten/HFC insert									
	SDMT 060212-MPH	BCP25M	5125079	●	1,0	6,75	2,5	2,5	1,2	
	SDMT 060212-MMH	BCM35M	5125081	●	1,0	6,75	2,5	2,5	1,2	
	SDMT 060212-MSH	BCS35M	5171191	●	1,0	6,75	2,5	2,5	1,2	
	SDMT 060212-MHH	BCH10M	5125083	●	1,0	6,75	2,5	2,5	1,2	
	SDMT 060212-MHH	BCH30M	5156757	●	1,0	6,75	2,5	2,5	1,2	

Bestellbeispiel Order example: 10 Stück pieces 5125079 oder or SDMT 060212-MPH BCP25M

Bestellbeispiel Order example: 1 Stück piece 5156789 oder or BSU90 SD06.1000 Z04 M12

DELTAtec 90P Feed

Systemgröße 10 System size 10



Aufsteckfräser 90° / SD.. 10 Face milling cutter 90° / SD.. 10

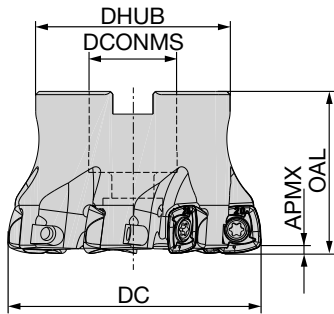

Abmessungen [mm] Dimensions [mm]							Artikelbezeichnung Item code	Bestell-Nr. Ordering No.	Verfügbarkeit Availability	Ersatzteile Spare parts		
DC	DCONMS	DHUB	OAL	APMX 90	APMX HFC	ZEFF [☆]						
40	16	35	40	9	1,5	4	BF90 SD10.040 Z04*	5081793	●	 * Differentialschraube SD10 Centre screw SD 10 5127661		
40	16	35	40	9	1,5	5	BF90 SD10.040 Z05	5224597	○			
40	16	35	40	9	1,5	6	BF90 SD10.040 Z06*	5081800	●			
42	16	35	40	9	1,5	5	BF90 SD10.042 Z05*	5109948	●			
50	22	43	40	9	1,5	5	BF90 SD10.050 Z05	5081802	●			
50	16	43	40	9	1,5	6	BF90 SD10.050 Z06	5218875	●			
50	22	43	40	9	1,5	7	BF90 SD10.050 Z07	5081804	●			
52	22	43	40	9	1,5	5	BF90 SD10.052 Z05	5095628	●			
52	22	43	40	9	1,5	6	BF90 SD10.052 Z06	5218879	●			
63	22	48	40	9	1,5	6	BF90 SD10.063 Z06	5081805	●			
63	22	48	40	9	1,5	8	BF90 SD10.063 Z08	5081808	●			
63	27	48	50	9	1,5	8	BF90 SD10.063 Z08 DA27	5214480	○			
66	22	48	40	9	1,5	5	BF90 SD10.066 Z05	5114793	○			
66	27	48	50	9	1,5	8	BF90 SD10.066 Z08 DA27	5149496	○			
80	27	60	50	9	1,5	8	BF90 SD10.080 Z08	5081810	●			
100	32	78	50	9	1,5	9	BF90 SD10.100 Z09	5184453	○			

Aufsteckfräser 90° / SD.. 10 / INCH Face milling cutter 90° / SD.. 10 / INCH

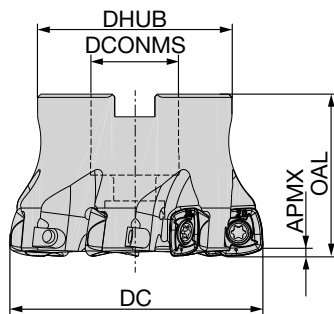

Abmessungen [INCH] Dimensions [INCH]							Artikelbezeichnung Item code	Bestell-Nr. Ordering No.	Verfügbarkeit Availability	Ersatzteile Spare parts		
DC	DCONMS	DHUB	OAL	APMX 90	APMX HFC	ZEFF [☆]						
2.0	0.75	1.750	1.50	0.354	0.059	5	BFU90 SD10.2000 Z05	5132691	○	 		
2.0	0.75	1.750	1.50	0.354	0.059	7	BFU90 SD10.2000 Z07	5132692	○			
2.5	1.00	2.250	1.75	0.354	0.059	6	BFU90 SD10.2500 Z06	5132693	○			
2.5	1.00	2.250	1.75	0.354	0.059	8	BFU90 SD10.2500 Z08	5132694	○			

Bestellbeispiel Order example: 1 Stück piece 5081793 oder or BF90 SD10.040 Z04

- Verfügbar ab Lager Available from stock
- Lieferzeit auf Anfrage Delivery time on request

DELTAtec 90P Feed

Systemgröße 10 System size 10

www.boehlerit.com

Schafffräser 90° / SD.. 10 End milling cutter 90° / SD.. 10

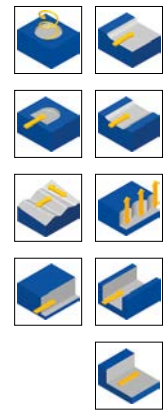
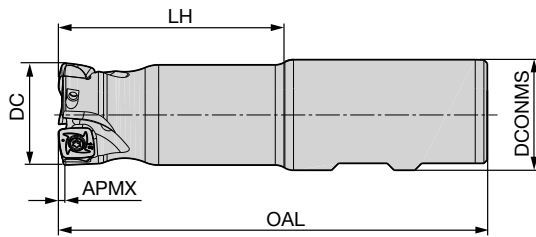

Abmessungen [mm] Dimensions [mm]							Bestellbezeichnung Ordering No.	Schaft Shank	Bestell-Nr. Ordering No.	Verfügbarkeit Availability	Ersatzteile Spare parts	
DC	DCONMS	LH	OAL	APMX 90°	APMX HFC	ZEFF [☆]					Spann- schraube Fixation screw AP02-30083 5112357 M _A = 2Nm	Torx- Schlüssel Torque wrench IP9 5118124
25	25	50	106	9	1,5	2	BE90 SD10.025 Z02	HB	5081816	●		
25	25	50	106	9	1,5	3	BE90 SD10.025 Z03	HB	5093502	●		
32	32	64	124	9	1,5	3	BE90 SD10.032 Z03	HB	5081819	●		

Schafffräser 90° / SD.. 10 / INCH End milling cutter 90° / SD.. 10 / INCH

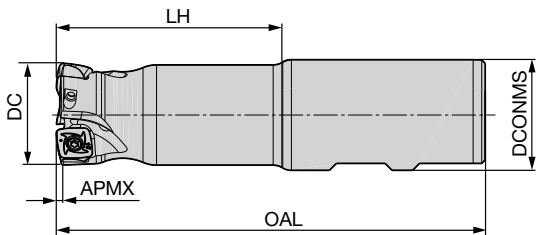

Abmessungen [INCH] Dimensions [INCH]							Bestellbezeichnung Ordering No.	Schaft Shank	Bestell-Nr. Ordering No.	Verfügbarkeit Availability	Ersatzteile Spare parts	
DC	DCONMS	LH	OAL	APMX 90°	APMX HFC	ZEFF [☆]					Spann- schraube Fixation screw AP02-30083 5112357 M _A = 2Nm	Torx- Schlüssel Torque wrench IP9 5118124
1.00	1.00	2,0	4,0	0.354	0.059	2	BEU90 SD10.1000 Z02 400	HB	5132695	○		
1.00	1.00	2,0	4,0	0.354	0.059	3	BEU90 SD10.1000 Z03 400	HB	5132696	○		
1.25	1.25	2,5	5,0	0.354	0.059	3	BEU90 SD10.1250 Z03 500	HB	5132697	○		
1.25	1.25	2,5	5,0	0.354	0.059	4	BEU90 SD10.1250 Z04 500	HB	5132698	○		

Bestellbeispiel Order example: 1 Stück piece 5081816 oder or BE90 SD10.025 Z02

Einschraubfräser 90° / SD.. 10 Screw on type 90° / SD.. 10

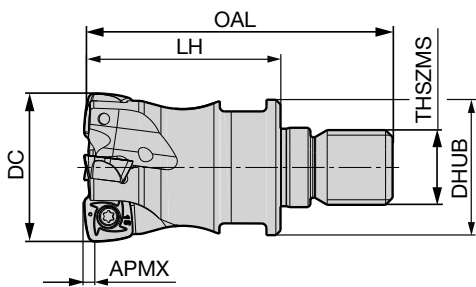

Abmessungen [mm] Dimensions [mm]								Artikelbezeichnung Item code	Bestell-Nr. Ordering No.	Verfügbarkeit Availability	Ersatzteile Spare parts	
DC	DHUB	LH	OAL	APMX 90°	APMX HFC	THSZMS	ZEFF [☼]					
25	21	32	54	9	1,5	M12	2	BS90 SD10.025 Z02 M12	5081821	●	 	
25	21	32	54	9	1,5	M12	3	BS90 SD10.025 Z03 M12	5093503	●		
32	29	43	66	9	1,5	M16	3	BS90 SD10.032 Z03 M16	5118310	●		
32	29	43	66	9	1,5	M16	4	BS90 SD10.032 Z04 M16	5081822	●		
35	29	43	66	9	1,5	M16	4	BS90 SD10.035 Z04 M16	5199265	○		
36	29	43	66	9	1,5	M16	4	BS90 SD10.036 Z04 M16	5153395	●		
40	29	43	66	9	1,5	M16	4	BS90 SD10.040 Z04 M16	5081824	●		
40	29	43	66	9	1,5	M16	6	BS90 SD10.040 Z06 M16	5156846	○		

Einschraubfräser 90° / SD.. 10 / INCH Screw on type 90° / SD.. 10 / INCH

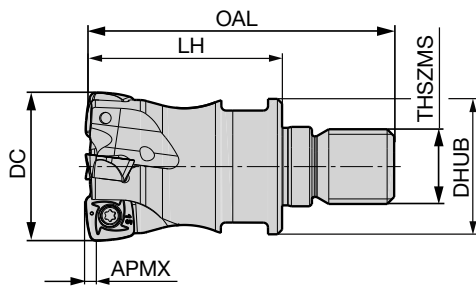

Abmessungen [INCH] Dimensions [INCH]								Artikelbezeichnung Item code	Bestell-Nr. Ordering No.	Verfügbarkeit Availability	Ersatzteile Spare parts	
DC	DHUB	LH	OAL	APMX 90°	APMX HFC	THSZMS	ZEFF [☼]					
1.00	0.8	1.257	2.13	0.354	0.059	M12	3	BSU90 SD10.1000 Z03 M12	5132700	○	 	

Bestellbeispiel Order example: 1 Stück piece 5081821 oder or BS90 SD10.025 Z02 M12
Die passenden Hartmetallverlängerungen finden Sie ab Seite 294
You will find the matching carbide extensions from page 294

● Verfügbar ab Lager Available from stock
○ Lieferzeit auf Anfrage Delivery time on request

DELTAtec 90P Feed

Systemgröße 10 System size 10

www.boehlerit.com

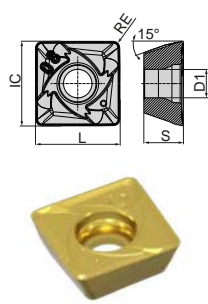
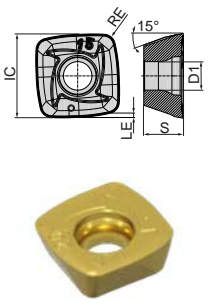
CEDC = Anzahl der Schneidkanten CEDC = Number of cutting edges	Artikelbezeichnung Item code	Schneidstoffsorte Cutting materials	Bestell-Nr. Ordering No.	Verfügbarkeit Availability	Abmessungen [mm] Dimensions [mm]						
					L	LE	IC	S	D1	RE	
 <p>CEDC = 4</p>	90° Platten/90° inserts										
	SDHT 100404 FR-MN	BCN10M	5141469	●	10,4	-	10,4	4,86	3,5	0,4	
	SDHT 100404 FR-MN	BWN10M	5141468	●	10,4	-	10,4	4,86	3,5	0,4	
	SDMT 100408 SR-MP	BCP25M	5092104	●	10,4	-	10,4	4,86	3,5	0,8	
	SDMT 100408 SR-MP	BCP35M	5081909	●	10,4	-	10,4	4,86	3,5	0,8	
	SDMT 100408 SR-MP	BCP40M	5092108	●	10,4	-	10,4	4,86	3,5	0,8	
	SDMT 100408 ER-MM	BCM35M	5092224	●	10,4	-	10,4	4,86	3,5	0,8	
	SDMT 100408 ER-MM	BCM40M	5081917	●	10,4	-	10,4	4,86	3,5	0,8	
	SDMT 100415 ER-MM	BCM35M	5121936	●	10,4	-	10,4	4,86	3,5	1,5	
	SDMT 100408 SR-MK	BCK20M	5081910	●	10,4	-	10,4	4,86	3,5	0,8	
	SDHT 100408 FR-MN	BCN10M	5141467	●	10,4	-	10,4	4,86	3,5	0,8	
	SDHT 100408 FR-MN	BWN10M	5141466	●	10,4	-	10,4	4,86	3,5	0,8	
	 <p>CEDC = 4</p>	HFC Platten/HFC inserts									
SDMT 100415 SR-MPH		BCP20M	5087590	●	-	1,1	10,2	4,86	3,5	1,5	
SDMT 100415 SR-MPH		BCP25M	5081918	●	-	1,1	10,2	4,86	3,5	1,5	
SDMT 100415 SR-MPH		BCP30M	5092114	●	-	1,1	10,2	4,86	3,5	1,5	
SDMT 100415 SR-MPH		BCP35M	5092113	●	-	1,1	10,2	4,86	3,5	1,5	
SDMT 100415 ER-MMH		BCM35M	5092231	●	-	1,1	10,2	4,86	3,5	1,5	
SDMT 100415 ER-MMH		BCM40M	5081922	●	-	1,1	10,2	4,86	3,5	1,5	
SDGT 100415 SR-MTH		BCS35M	5125072	●	-	1,1	10,2	4,86	3,5	1,5	
SDMT 100415 SR-MSH		BCS35M	5158371	●	-	1,1	10,2	4,86	3,5	1,5	
SDMT 100415 SR-MSH		BCS40M	5168096	●	-	1,1	10,2	4,86	3,5	1,5	
SDMT 100415 SR-MHH		BCH10M	5117559	●	-	1,1	10,2	4,86	3,5	1,5	
SDMT 100415 SR-MHH		BCH30M	5145418	●	-	1,1	10,2	4,86	3,5	1,5	
HFC Platten/HFC inserts											
SDMW 100415 SR-RPH		BCP20M	5092120	●	-	1,1	10,2	4,86	3,5	1,5	
SDMW 100415 SR-RPH		BCP25M	5092116	●	-	1,1	10,2	4,86	3,5	1,5	
SDMW 100415 SR-RPH		BCP30M	5087591	●	-	1,1	10,2	4,86	3,5	1,5	
SDMW 100415 SR-RPH		BCP35M	5081919	●	-	1,1	10,2	4,86	3,5	1,5	
SDMW 100415 SR-RKH		BCK15M	5087592	●	-	1,1	10,2	4,86	3,5	1,5	
SDMW 100415 SR-RKH		BCK20M	5081920	●	-	1,1	10,2	4,86	3,5	1,5	
SDMW 100415 SR-RHH		BCH05M	5117552	●	-	1,1	10,2	4,86	3,5	1,5	
SDMW 100415 SR-RHH	BCH10M	5117553	●	-	1,1	10,2	4,86	3,5	1,5		
SDMW 100415 SR-RHH	BCH30M	5117557	●	-	1,1	10,2	4,86	3,5	1,5		

Bestellbeispiel Order example: 10 Stück pieces 5141469 oder or SDHT 100404 FR-MN BCN10M

Aufsteckfräser 90° / SD.. 14 Face milling cutter 90° / SD.. 14

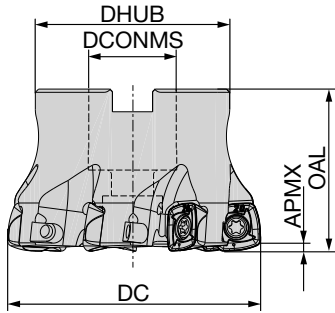

Abmessungen [mm] Dimensions [mm]							Artikelbezeichnung Item code	Bestell-Nr. Ordering No.	Verfügbarkeit Availability	Ersatzteile Spare parts		
DC	DCONMS	DHUB	OAL	APMX 90°	APMX HFC	ZEFF [☼]						
50	22	43	40	12	2,5	4	BF90 SD14.050 Z04 *	5123456	●	 * Differenzialschraube SD14 Centre screw SD14 5111638		
50	22	43	40	12	2,5	5	BF90 SD14.050 Z05 *	5081825	●			
52	22	43	40	12	2,5	4	BF90 SD14.052 Z04 *	5095629	●			
52	22	43	40	12	2,5	5	BF90 SD14.052 Z05 *	5095630	●			
63	22	48	40	12	2,5	6	BF90 SD14.063 Z06	5081828	●			
63	27	60	50	12	2,5	6	BF90 SD14.063 Z06 DA27	5157351	●			
66	22	48	40	12	2,5	6	BF90 SD14.066 Z06	5092552	●			
66	27	60	50	12	2,5	6	BF90 SD14.066 Z06 DA27	5157359	●			
80	27	60	50	12	2,5	7	BF90 SD14.080 Z07	5081829	●			
85	27	60	50	12	2,5	7	BF90 SD14.085 Z06	5114794	○			
100	32	78	50	12	2,5	7	BF90 SD14.100 Z07	5100338	●			
100	32	78	50	12	2,5	9	BF90 SD14.100 Z09	5081830	●			
125	40	90	60	12	2,5	9	BF90 SD14.125 Z09	5190342	●			
125	40	90	60	12	2,5	11	BF90 SD14.125 Z11	5081831	●			
160	40	90	60	12	2,5	10	BF90 SD14.160 Z10	5096828	●			

Aufsteckfräser 90° / SD.. 14 / INCH Face milling cutter 90° / SD.. 14 / INCH

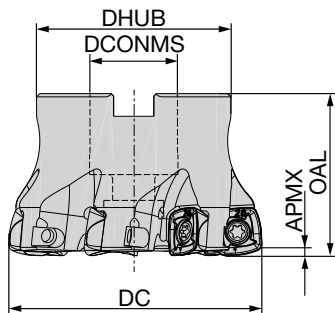

Abmessungen [INCH] Dimensions [INCH]							Artikelbezeichnung Item code	Bestell-Nr. Ordering No.	Verfügbarkeit Availability	Ersatzteile Spare parts		
DC	DCONMS	DHUB	OAL	APMX 90°	APMX HFC	ZEFF [☼]						
2.0	0.75	1.75	1.50	0.472	0.098	4	BFU90 SD14.2000 Z04	5132705	○			
2.0	0.75	1.75	1.50	0.472	0.098	5	BFU90 SD14.2000 Z05	5132706	○			
2.5	1.00	2.25	1.75	0.472	0.098	6	BFU90 SD14.2500 Z06	5132707	○			
3.0	1.00	2.25	2.00	0.472	0.098	5	BFU90 SD14.3000 Z05	5132708	○			
3.0	1.00	2.25	2.00	0.472	0.098	7	BFU90 SD14.3000 Z07	5132709	○			
4.0	1.50	3.75	2.25	0.472	0.098	7	BFU90 SD14.4000 Z07	5132710	○			
4.0	1.50	3.75	2.25	0.472	0.098	9	BFU90 SD14.4000 Z09	5132711	○			
5.0	1.50	3.75	2.50	0.472	0.098	9	BFU90 SD14.5000 Z09	5132712	○			

Bestellbeispiel Order example: 1 Stück piece 5123456 oder or BF90 SD14.050 Z04

● Verfügbar ab Lager Available from stock
○ Lieferzeit auf Anfrage Delivery time on request

DELTAtec 90P Feed

Systemgröße 14 System size 14

www.boehlerit.com

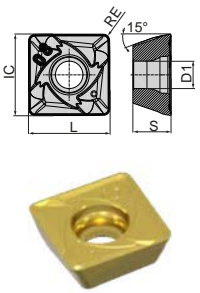
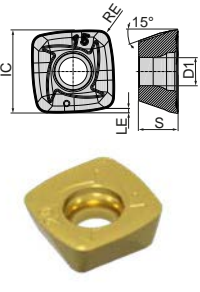
CEDC = Anzahl der Schneidkanten CEDC = Number of cutting edges	Artikelbezeichnung Item code	Schneidstoffsorte Cutting materials	Bestell-Nr. Ordering No.	Verfügbarkeit Availability	Abmessungen [mm] Dimensions [mm]					
					L	LE	IC	S	D1	RE
 <p>CEDC = 4</p>	90° Platten/90° inserts									
	SDHT 140508 FR-MN	BCN10M	5141465	○	14,8		14,8	5,2	5,5	0,8
	SDHT 140508 FR-MN	BWN10M	5141463	●	14,8		14,8	5,2	5,5	0,8
	SDMT 140512 SR-MP	BCP25M	5092127	●	14,8		14,8	5,2	5,5	1,2
	SDMT 140512 SR-MP	BCP35M	5081923	●	14,8		14,8	5,2	5,5	1,2
	SDMT 140512 SR-MP	BCP40M	5092129	●	14,8		14,8	5,2	5,5	1,2
	SDMT 140512 ER-MM	BCM35M	5092266	●	14,8		14,8	5,2	5,5	1,2
	SDMT 140512 ER-MM	BCM40M	5081925	●	14,8		14,8	5,2	5,5	1,2
	SDMT 140512 SR-MK	BCK20M	5081924	●	14,8		14,8	5,2	5,5	1,2
	SDHT 140512 FR-MN	BCN10M	5141464	○	14,8		14,8	5,2	5,5	1,2
	SDHT 140512 FR-MN	BWN10M	5141462	●	14,8		14,8	5,2	5,5	1,2
	 <p>CEDC = 4</p>	HFC Platten/HFC inserts								
SDMT 140520 SR-MPH		BCP20M	5087593	●		2,2	14,7	5	5,5	2
SDMT 140520 SR-MPH		BCP25M	5081926	●		2,2	14,7	5	5,5	2
SDMT 140520 SR-MPH		BCP30M	5092131	●		2,2	14,7	5	5,5	2
SDMT 140520 SR-MPH		BCP35M	5092130	●		2,2	14,7	5	5,5	2
SDMT 140520 ER-MMH		BCM35M	5092290	●		2,2	14,7	5	5,5	2
SDMT 140520 ER-MMH		BCM40M	5081929	●		2,2	14,7	5	5,5	2
SDMT 140520 SR-MSH		BCS35M	5158373	●		2,2	14,7	5	5,5	2
SDMT 140520 SR-MSH		BCS40M	5168098	●		2,2	14,7	5	5,5	2
SDMT 140520 SR-MHH		BCH10M	5117569	●		2,2	14,7	5	5,5	2

Bestellbeispiel Order example: 10 Stück pieces 5141463 oder or SDHT 140508 FR-MN BWN10M

Aufsteckfräser 90° / SD.. 18
Face milling cutter 90°/ SD.. 18

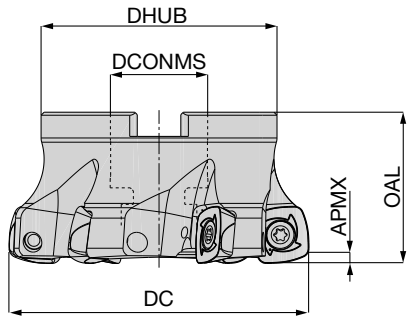

Abmessungen [mm] Dimensions [mm]						Artikelbezeichnung Item code	Bestell-Nr. Ordering No.	Verfügbarkeit Availability	Ersatzteile Spare parts		
DC	DCONMS	DHUB	OAL	APMX HFC	ZEFF [⊙]				 Spannschraube Fixation screw A02-60160 6401270 M _A = 6Nm	 Torx-Schlüssel Torque wrench T25 5088518	
63	27	60	50	3,5	4	BF90 SD18.063 Z04 DA27	5168687	○			
80	27	60	50	3,5	5	BF90 SD18.080 Z05	5119894	●			
100	32	78	50	3,5	6	BF90 SD18.100 Z06	5108676	●			
125	40	90	60	3,5	7	BF90 SD18.125 Z07	5119895	●			
160	40	115	60	3,5	9	BF90 SD18.160 Z09 NC	5119899	●			
200	60	140	65	3,5	11	BF90 SD18.200 Z11 NC	5119900	●			

Bestellbeispiel Order example: 1 Stück piece 5168687 oder or BF90 SD18.063 Z04 DA27

CEDC = Anzahl der Schneidkanten CEDC = Number of cutting edges	Artikelbezeichnung Item code	Schneidstoffsorte Cutting materials	Bestell-Nr. Ordering No.	Verfügbarkeit Availability	Abmessungen [mm] Dimensions [mm]					
					LE	IC	S	D1	RE	
 CEDC = 4	HFC Platten/HFC inserts									
	SDMT 180630 SR-MPH	BCP25M	5117595	●	3,0	18,7	6	6,5	3	
	SDMT 180630 SR-MPH	BCP35M	5117594	●	3,0	18,7	6	6,5	3	
	SDMT 180630 SR-MMH	BCM35M	5117596	●	3,0	18,7	6	6,5	3	
	SDMT 180630 SR-MMH	BCM40M	5117597	●	3,0	18,7	6	6,5	3	
	SDMT 180630 SR-MSH	BCS35M	5171192	○	3,0	18,7	6	6,5	3	
	SDMT 180630 SR-MHH	BCH30M	5170536	●	3,0	18,7	6	6,5	3	
	SDMW 180630 SR-RPH	BCP35M	5117598	●	3,0	18,7	6	6,5	3	
	SDMW 180630 SR-RPH	BCP40M	5117599	●	3,0	18,7	6	6,5	3	
	SDMW 180630 SR-RKH	BCK15M	5118026	○	3,0	18,7	6	6,5	3	
	SDMW 180630 SR-RKH	BCK20M	5117600	●	3,0	18,7	6	6,5	3	
	SDMW 180630 SR-RHH	BCH30M	5117601	●	3,0	18,7	6	6,5	3	

Bestellbeispiel Order example: 10 Stück pieces 5117595 oder or SDMT 180630 SR-MPH BCP25M

● Verfügbar ab Lager Available from stock
○ Lieferzeit auf Anfrage Delivery time on request

	Aufsteckfräser 90° Face milling cutter 90°	Schaftfräser 90° End milling cutter 90°
Ausführung Execution		
Durchmesserbereich metrisch Diameter range metric	Ø 40 - 160 mm	Ø 20 - 40 mm
Plattengröße Insert size	LN..10, LN..15	LN..10, LN..15

Besondere Merkmale:

- Stabiles Werkzeugsystem durch negatives Geometriegrundkonzept
- Effektiv positiver Spanwinkel für leichten Schnitt
- Produktivität ist gewährleistet durch 4 Schneidkanten
- Verfügbar in 2 Plattengrößen
- Schaftfräser in Überlänge verfügbar
- Artikel mit Status "Lieferzeit auf Anfrage" in fünf Arbeitstagen lieferbar

Special features:

- Stable tool system through negative geometry basic design
- Effective positive chip angle for smooth cut
- Productivity guaranteed through 4 cutting edges
- Available in 2 insert sizes
- End milling cutter in excess length available
- Article with status "Delivery time on request" are deliverable in five working days

WSP Geometrie Insert geometry	LNMX 10		LNMX 15	
	Schnitttiefe* Cutting depth* [mm] APMX max	Vorschub* Feed* [mm] f _z	Schnitttiefe* Cutting depth* [mm] APMX max	Vorschub* Feed* [mm] f _z
RP	1,0 4,0 9,0	0,2 0,3 0,4	1,0 6,5 14,0	0,2 0,3 0,4
RM	1,0 4,0 9,0	0,2 0,2 0,3	1,0 6,5 12,0	0,2 0,2 0,3
RK	1,0 4,0 9,0	0,2 0,2 0,3	1,0 6,5 14,0	0,2 0,3 0,4

Schnittwertempfehlungen siehe Seite 130
Cutting data recommendations page 130

- * Angegebene Schnittdaten sind als Richtwert zu sehen, welche durch Versuche für jeden Anwendungsfall separat optimiert werden können.
- * Recommended cutting data has to be seen as a reference which can be optimised for each application through trials separately.

Aufsteckfräser 90° / LN.. 10
Face milling cutter 90° / LN.. 10

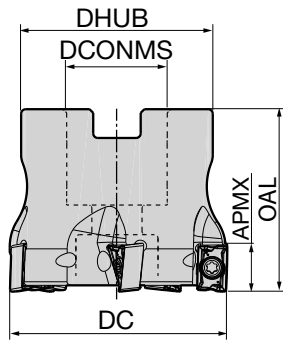

Abmessungen [mm] Dimensions [mm]						Artikelbezeichnung Item code	Bestell-Nr. Ordering No.	Verfügbarkeit Availability	Ersatzteile Spare parts	
DC	DCONMS	DHUB	OAL	APMX	ZEFF [☆]				Spannschraube Fixation screw A02-30076 5084082 M _A = 2Nm	Torx-Schlüssel Torque wrench T9 5088515
40	16	35	9	40	4	BF90 LN10.040 Z04	5079203	●		
40	16	35	9	40	5	BF90 LN10.040 Z05	5085886	○		
50	22	42	9	40	5	BF90 LN10.050 Z05	5079204	●		
50	22	42	9	40	7	BF90 LN10.050 Z07	5079205	●		
63	22	49	9	40	6	BF90 LN10.063 Z06	5093663	●		
63	22	49	9	40	8	BF90 LN10.063 Z08	5093664	●		

Schafffräser 90° / LN.. 10
End milling cutter 90° / LN.. 10

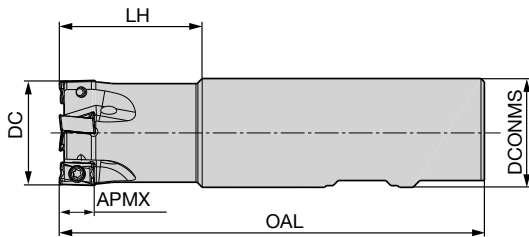

Abmessungen [mm] Dimensions [mm]						Artikelbezeichnung Item code	Schaft Shank	Bestell-Nr. Ordering No.	Verfügbarkeit Availability	Ersatzteile Spare parts	
DC	DCONMS	LH	OAL	APMX	ZEFF [☆]					Spannschraube Fixation screw A02-30076 5084082 M _A = 2Nm	Torx-Schlüssel Torque wrench T9 5088515
20	20	30	100	9	2	BE90 LN10.020 Z02	HB	5079206	●		
20	20	30	150	9	2	BE90 LN10.020 Z02 150	HA	5085887	○		
20	20	30	100	9	3	BE90 LN10.020 Z03	HB	5085888	●		
25	25	35	115	9	2	BE90 LN10.025 Z02	HB	5085890	○		
25	25	35	150	9	2	BE90 LN10.025 Z02 150	HA	5085889	○		
25	25	35	115	9	3	BE90 LN10.025 Z03	HB	5079207	●		
32	32	42	120	9	3	BE90 LN10.032 Z03	HB	5085891	○		
32	32	42	180	9	3	BE90 LN10.032 Z03 180	HA	5085892	○		
32	32	42	120	9	4	BE90 LN10.032 Z04	HB	5079208	○		
40	32	42	125	9	4	BE90 LN10.040 Z04	HB	5085894	○		
40	32	42	125	9	5	BE90 LN10.040 Z05	HB	5085893	○		

- Verfügbar ab Lager Available from stock
- kurzfristig lieferbar available at short notice
- Lieferzeit auf Anfrage Delivery time on request

Bestellbeispiel Order example: 1 Stück piece 5079203 oder or BE90 LN10.040 Z04

DELTAtec 90N

Systemgröße 10/15 System size 10/15

www.boehlerit.com

CEDC = Anzahl der Schneidkanten CEDC = Number of cutting edges	Artikelbezeichnung Item code	Schneidstoffsorte Cutting materials	Bestell-Nr. Ordering No.	Verfügbarkeit Availability	Abmessungen [mm] Dimensions [mm]				
					L	IC	S	D1	RE
	LNMX 100605 SR-RP	BCP25M	5085137	●	10	6,6	6,35	2,8	0,5
	LNMX 100605 SR-RP	BCP35M	5081015	●	10	6,6	6,35	2,8	0,5
	LNMX 100605 SR-RP	BCP40M	5081956	●	10	6,6	6,35	2,8	0,5
	LNMX 100605 SR-RM	BCM40M	5105547	●	10	6,6	6,35	2,8	0,5
	LNMX 100605 SR-RK	BCK15M	5092063	●	10	6,6	6,35	2,8	0,5
	LNMX 100605 SR-RK	BCK20M	5081881	●	10	6,6	6,35	2,8	0,5
N = 4									

Bestellbeispiel Order example: 10 Stück pieces 5085137 oder or LNMX 100605 SR-RP BCP25M

Aufsteckfräser 90° / LN.. 15 Face milling cutter 90° / LN.. 15

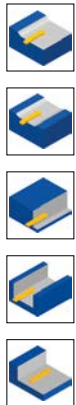
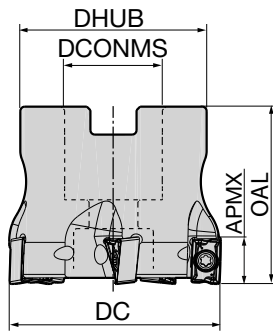

Abmessungen [mm] Dimensions [mm]						Artikelbezeichnung Item code	Bestell-Nr. Ordering No.	Verfügbarkeit Availability	Ersatzteile Spare parts	
DC	DCONMS	DHUB	OAL	APMX	ZEFF					
50	22	42	40	14	3	BF90 LN15.050 Z03	5085896	●		
50	22	42	40	14	4	BF90 LN15.050 Z04	5079209	●		
63	22	49	40	14	4	BF90 LN15.063 Z04	5085900	○		
63	22	49	40	14	6	BF90 LN15.063 Z06	5079210	●		
80	27	60	50	14	5	BF90 LN15.080 Z05	5085902	○		
80	27	60	50	14	7	BF90 LN15.080 Z07	5079211	●		
100	32	60	50	14	8	BF90 LN15.100 Z08	5110314	○		
125	40	90	63	14	10	BF90 LN15.125 Z10	5110286	○		
160	40	115	63	14	11	BF90 LN15.160 Z11	5109145	●		

Bestellbeispiel Order example: 1 Stück piece 5085896 oder or BF90 LN15.050 Z03

Schaftfräser 90° / LN.. 15
End milling cutter 90° / LN.. 15

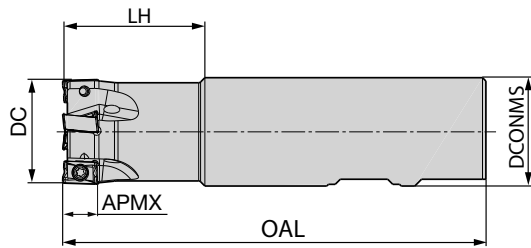

Abmessungen [mm] Dimensions [mm]						Artikelbezeichnung Item code	Schaft Shank	Bestell-Nr. Ordering No.	Verfügbarkeit Availability	Ersatzteile Spare parts	
DC	DCONMS	DHUB	OAL	APMX	ZEFF					Spann- schraube Fixation screw AP13-40110 5084084 M _A = 3Nm	Torx- Schlüssel Torque wrench IP15 5088520
32	32	125	14	40	3	BE90 LN15.032 Z03	HB	5085904	●		
40	32	130	14	40	3	BE90 LN15.040 Z03	HB	5085906	○		
40	32	130	14	40	4	BE90 LN15.040 Z04	HB	5085905	●		

Bestellbeispiel Order example: 1 Stück piece 5085904 oder or BE90 LN15.032 Z03

CEDC = Anzahl der Schneidkanten CEDC = Number of cutting edges	Artikelbezeichnung Item code	Schneidstoffsorte Cutting materials	Bestell-Nr. Ordering No.	Verfügbarkeit Availability	Abmessungen [mm] Dimensions [mm]				
					L	IC	S	D1	RE
 CEDC = 4	LNMX 151008 SR-RP	BPC25M	5085138	●	15	9,52	10,0	4,5	0,8
	LNMX 151008 SR-RP	BPC35M	5081016	●	15	9,52	10,0	4,5	0,8
	LNMX 151008 SR-RP	BPC40M	5081957	●	15	9,52	10,0	4,5	0,8
	LNMX 151008 SR-RM	BCM40M	5105540	●	15	9,52	10,0	4,5	0,8
	LNMX 151008 SR-RK	BCK15M	5092102	●	15	9,52	10,0	4,5	0,8
	LNMX 151008 SR-RK	BCK20M	5081017	●	15	9,52	10,0	4,5	0,8

- Verfügbar ab Lager Available from stock
- kurzfristig lieferbar available at short notice
- Lieferzeit auf Anfrage Delivery time on request

Bestellbeispiel Order example: 10 Stück pieces 5085138 oder or LNMX 151008 SR-RP BCP25M

	Aufsteckfräser 90° Face milling cutter 90°	Schafffräser 90° End milling cutter 90°
Ausführung Execution		
Durchmesserbereich metrisch Diameter range metric	Ø 40 - 315 mm	Ø 20 - 32 mm
Plattengröße Insert size	LN..09, LN13	LN..09

Besondere Merkmale:

- Durch tangentielle Klemmung der Platten ergibt sich ein sehr stabiles Werkzeugsystem
- Produktivität gewährleistet durch 4 Schneiden
- Hohe Bearbeitungssicherheit durch dicke Tangentialplatte
- Leichter Schnitt durch Helixgeometrie an den Schneidkanten

Special features:

- Due to tangential clamping of the inserts a very stable tool system result
- Productivity guaranteed through 4 cutting edges
- High machining security through thick tangential milling insert
- Smooth cut through helix geometry on the cutting edges

90° Fräsparameter 90° Milling parameter

WSP Geometrie Insert geometry	LNMX 09	
	Schnitttiefe* Cutting depth* [mm] APMX max	Vorschub* Feed* [mm] fz
MP	1,0 3,5 8,0	0,13 0,2 0,3
MM	1,0 3,5 8,0	0,13 0,2 0,3
MK	1,0 3,5 8,0	0,13 0,2 0,3

Walzenstirnfräser Helical cutter

WSP Geometrie Insert geometry	LNMX 09	
	Schnittbreite* Cutting width* [D x %] a _e max	Vorschub* Feed* [mm] fz
MP	5 - 70%	0,1 0,15 0,2
MM	5 - 70%	0,1 0,15 0,2
MK	5 - 70%	0,1 0,2 0,25

WSP Geometrie Insert geometry	LNMX 13	
	Schnitttiefe* Cutting depth* [mm] APMX max	Vorschub* Feed* [mm] fz
MP	1,0 6,5 12,0	0,2 0,2 0,4
MM	1,0 6,5 12,0	0,2 0,2 0,4
RP	1,0 6,5 12,0	0,2 0,3 0,5
RK	1,0 6,5 12,0	0,3 0,4 0,6

Schnittwertempfehlungen siehe Seite 130
Cutting data recommendations page 130

* Angegebene Schnittdaten sind als Richtwert zu sehen, welche durch Versuche für jeden Anwendungsfall separat optimiert werden können.
* Recommended cutting data has to be seen as a reference which can be optimised for each application through trials separately.

Aufsteckfräser 90° / LN.. 09 Face milling cutter 90° / LN.. 09

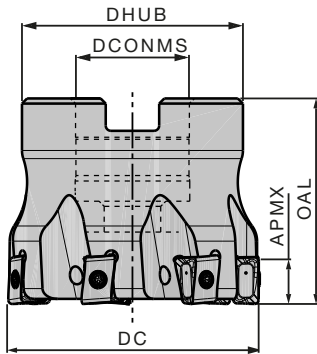

Abmessungen [mm] Dimensions [mm]						Artikelbezeichnung Item code	Bestell-Nr. Ordering No.	Verfügbarkeit Availability	Ersatzteile Spare parts	
DC	DCONMS	DHUB	OAL	APMX	ZEFF					
40	16	36	40	8	4	BF90 LN09.040 Z04	5191015	●		
40	16	36	40	8	6	BF90 LN09.040 Z06	5191017	●		
50	22	40	40	8	5	BF90 LN09.050 Z05	5191023	●		
50	22	40	40	8	7	BF90 LN09.050 Z07	5191027	●		
63	22	48	40	8	6	BF90 LN09.063 Z06	5191035	●		
63	22	48	40	8	9	BF90 LN09.063 Z09	5191036	●		
80	27	58	50	8	7	BF90 LN09.080 Z07	5191038	●		
80	27	58	50	8	10	BF90 LN09.080 Z010	5191041	●		

Schaftfräser 90° / LN.. 09 End milling cutter 90° / LN.. 09

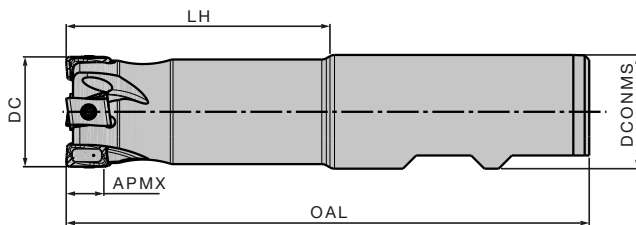

Abmessungen [mm] Dimensions [mm]						Artikelbezeichnung Item code	Schaft Shank	Bestell-Nr. Ordering No.	Verfügbarkeit Availability	Ersatzteile Spare parts	
DC	DCONMS	OAL	APMX	LH	ZEFF						
20	20	100	8	45	3	BE90 LN09.020 Z03	HB	5191043	●		
20	20	150	8	93	3	BE90 LN09.020 Z03 150	HA	5191045	●		
25	25	115	8	54	4	BE90 LN09.025 Z04	HB	5191047	●		
25	25	150	8	87	4	BE90 LN09.025 Z04 150	HA	5191053	●		
32	32	125	8	60	5	BE90 LN09.032 Z05	HB	5191055	●		
32	32	180	8	113	5	BE90 LN09.032 Z05 180	HA	5191059	●		

Bestellbeispiel Order example: 1 Stück piece 5191015 oder or BF90 LN09.040 Z04

- Verfügbar ab Lager Available from stock
- Lieferzeit auf Anfrage Delivery time on request

Aufsteckfräser 90° / LN.. 09
Face milling cutter 90° / LN.. 09

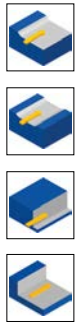
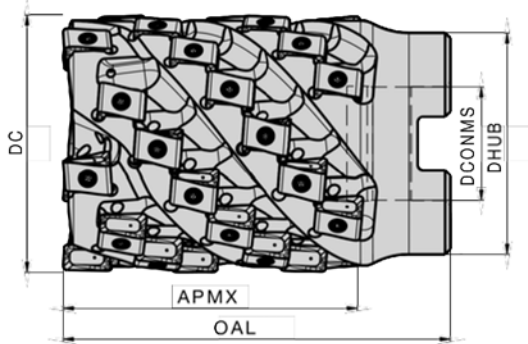

Abmessungen [mm] Dimensions [mm]						WSP Insert	Artikelbezeichnung Item code	Bestell-Nr. Ordering No.	Verfügbarkeit Availability	Ersatzteile Spare parts	
DC	DCONMS	DHUB	OAL	APMX	ZEFF						
40	16	35	60	43	4	24	BFH90 LN09.040 Z04 043	5217983	○	<p>Spannschraube Fixation screw AP06-22090 5187446 M_A = 1,2Nm</p> <p>Torx-Schlüssel Torque wrench IP7 5118123</p>	
50	22	43	75	57	5	40	BFH90 LN09.050 Z05 057	5200591	●		
63	22	56	75	57	6	48	BFH90 LN09.063 Z06 057	5217004	○		

CEDC = Anzahl der Schneidkanten CEDC = Number of cutting edges	Artikelbezeichnung Item code	Schneidstoffsorte Cutting materials	Bestell-Nr. Ordering No.	Verfügbarkeit Availability	Abmessungen [mm] Dimensions [mm]				
					L	IC	S	D1	RE
<p>CEDC = 4</p>	LNMX 090708 SR-MP	BCP25M	5192091	●	9,0	5,0	7,21	2,5	0,8
	LNMX 090708 SR-MP	BCP35M	5192093	●	9,0	5,0	7,21	2,5	0,8
	LNMX 090708 SR-MM	BCM40M	5192095	○	9,0	5,0	7,21	2,5	0,8
	LNMX 090708 SR-MK	BCK20M	5192094	●	9,0	5,0	7,21	2,5	0,8

Bestellbeispiel Order example: 1 Stück piece 5191043 oder or BF90 LN09.020 Z03

Aufsteckfräser 90° / LN.. 13
Face milling cutter 90° / LN.. 13

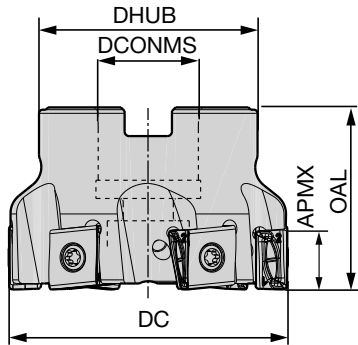

Abmessungen [mm]		Dimensions [mm]		Artikelbezeichnung Item code	Bestell-Nr. Ordering No.	Verfügbarkeit Availability	Ersatzteile Spare parts	
DC	DCONMS	DHUB	OAL				APMX	ZEFF
50	22	40	40	12	4	BF90 LN13.050 Z04	5083667	●
50	22	40	40	12	5	BF90 LN13.050 Z05	5107833	○
63	22	48	40	12	4	BF90 LN13.063 Z04	5083664	●
63	22	48	40	12	6	BF90 LN13.063 Z06	5083666	●
63	22	48	40	12	8	BF90 LN13.063 Z08	5107834	●
80	27	58	50	12	5	BF90 LN13.080 Z05	5104568	○
80	27	58	50	12	7	BF90 LN13.080 Z07	5083669	●
80	27	58	50	12	10	BF90 LN13.080 Z10	5107837	●
100	32	78	50	12	8	BF90 LN13.100 Z08	5093002	●
100	32	78	50	12	13	BF90 LN13.100 Z13	5107842	○
125	40	90	63	12	9	BF90 LN13.125 Z09	5093003	●
125	40	90	63	12	11	BF90 LN13.125 Z11	5107843	○
160	40	90	63	12	10	BF90 LN13.160 Z10 NC	5093004	●
200	60	140	75	12	14	BF90 LN13.200 Z14 NC	5090807	○
250	60	190	75	12	16	BF90 LN13.250 Z16 NC	5093005	○
315	60	255	75	12	18	BF90 LN13.315 Z18 NC	5093006	○

Bestellbeispiel Order example: 1 Stück piece 5083667 oder or BF90 LN13.050 Z04

NC = Keine Kühlung / no coolant

CEDC = Anzahl der Schneidkanten CEDC = Number of cutting edges	Artikelbezeichnung Item code	Schneidstoffsorte Cutting materials	Bestell-Nr. Ordering No.	Verfügbarkeit Availability	Abmessungen [mm] Dimensions [mm]				
					L	IC	S	D1	RE
 CEDC = 4	LNMX 131308 SR-MP	BCP25M	5092053	●	13	7	13	4,6	0,8
	LNMX 131308 SR-MP	BCP35M	5092051	●	13	7	13	4,6	0,8
	LNMX 131308 SR-MM	BCM40M	5105549	●	13	7	13	4,6	0,8
	LNMX 131308 SR-RP	BCP30M	5092037	●	13	7	13	4,6	0,8
	LNMX 131308 SR-RP	BCP35M	5081018	●	13	7	13	4,6	0,8
	LNMX 131308 SR-RP	BCP40M	5081019	○	13	7	13	4,6	0,8
	LNMX 131308 SR-RK	BCK15M	5092038	●	13	7	13	4,6	0,8
	LNMX 131308 SR-RK	BCK20M	5081867	●	13	7	13	4,6	0,8

- Verfügbar ab Lager Available from stock
- kurzfristig lieferbar available at short notice
- Lieferzeit auf Anfrage Delivery time on request

Bestellbeispiel Order example: 10 Stück pieces 5092053 oder or LNMX 131308 SR-MP BCP25M

	Aufsteckfräser 90° Face milling cutter 90°	Schaftfräser 90° End milling cutter 90°
Ausführung Execution		
Durchmesserbereich metrisch Diameter range metric	Ø 32 - 160 mm	Ø 20 - 32 mm
Durchmesserbereich inch Diameter range inch	Ø 2" - 6"	-
Plattengröße Insert size	WN.. 04, WN.. 08	WN.. 04

Besondere Merkmale:

- Stabiles Werkzeugsystem durch negatives Geometriegrundkonzept, wodurch die Prozesssicherheit bei der Schruppbearbeitung gegeben ist.
- 6 Schneidkanten zur Produktivitätssteigerung beim Eckfräsen 90°
- Effektiv positiver Spanwinkel für leichten Schnitt
- Höchste Wirtschaftlichkeit pro Schneide

Special features:

- Stable tool system through negative geometry basic design therefore process security on roughing
- 6 cutting edges for increase of productivity on 90° edge milling
- Effective positive chip angle for smooth cut
- Highest efficiency per cutting edges

WSP Geometrie Insert geometry	WNEX 04		WNEX 08	
	Schnitttiefe* Cutting depth* [mm] APMX max	Vorschub* Feed* [mm] f _z	Schnitttiefe* Cutting depth* [mm] APMX max	Vorschub* Feed* [mm] f _z
MP	0,4 2,0 4,0	0,1 0,2 0,3	-	-
MM	0,4 2,0 4,0	0,1 0,18 0,2	-	-
MK	0,4 2,0 4,0	0,1 0,2 0,3	-	-
MN	-	-	1,0 4,0 7,0	0,2 0,3 0,4
MH	0,4 2,0 4,0	0,08 0,15 0,18	0,8 4,0 7,0	0,15 0,18 0,23
RP	-	-	1,0 4,0 7,0	0,2 0,2 0,3
RM	-	-	1,0 4,0 7,0	0,2 0,2 0,3
RK	-	-	1,0 4,0 7,0	0,2 0,3 0,4

90° Eintauchwinkel
90° Ramping angle



Durchmesser Fräser Diameter Milling cutter	Eintauchwinkel 90°-Fräser max. α Ramping angle 90° milling cutter α max. WNEX 08
Ø 40	0,50°
Ø 50	0,46°
Ø 63	0,36°
Ø 80	0,23°
Ø 100	0,17°
Ø 125	0,12°
Ø 160	0,07°

Schnittwertempfehlungen siehe Seite 130
Cutting data recommendations page 130

- * Angegebene Schnittdaten sind als Richtwert zu sehen, welche durch Versuche für jeden Anwendungsfall separat optimiert werden können.
- * Recommended cutting data has to be seen as a reference which can be optimised for each application through trials separately.

Aufsteckfräser 90° / WN.. 04
Face milling cutter 90° / WN.. 04

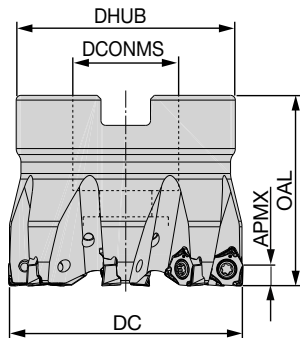

Abmessungen [mm]		Dimensions [mm]				Artikelbezeichnung Item code	Bestell-Nr. Ordering No.	Verfügbarkeit Availability	Ersatzteile Spare parts	
DC	DCONMS	DHUB	OAL	APMX	ZEFF [☆]				Spann- schraube Fixation screw AP02-25064 5127961 M _A = 1,5Nm	Torx- Schlüssel Torque wrench IP7 5118123
32	16	30	40	4	6	BF90 WN04.032 Z06	5127239	●		
40	16	36	40	4	6	BF90 WN04.040 Z06	5127240	●		
50	22	46	40	4	8	BF90 WN04.050 Z08	5127241	●		
63	22	48	40	4	9	BF90 WN04.063 Z09	5127242	●		

Schaftfräser 90° / WN.. 04
End milling cutter 90° / WN.. 04

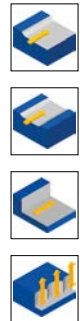
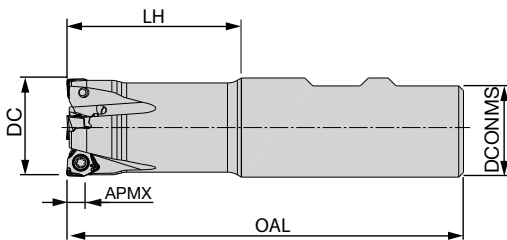

Abmessungen [mm]		Dimensions [mm]				Artikelbezeichnung Item code	Schaft Shank	Bestell-Nr. Ordering-No	Verfügbarkeit Availability	Ersatzteile Spare parts	
DC	DCONMS	DHUB	OAL	APMX	ZEFF [☆]					Spann- schraube Fixation screw AP02-25064 5127961 M _A = 1,5Nm	Torx- Schlüssel Torque wrench IP7 5118123
20	20	40	90	4	3	BE90 WN04.020 Z03	HB	5127236	●		
25	25	44	100	4	4	BE90 WN04.025 Z04	HB	5127237	●		
32	32	50	110	4	5	BE90 WN04.032 Z05	HB	5127238	○		

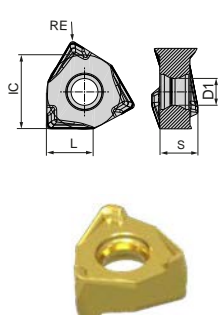
CEDC = Anzahl der Schneidkanten CEDC = Number of cutting edges	Artikelbezeichnung Item code	Schneidstoffsorte Cutting materials	Bestell-Nr. Ordering No.	Verfügbarkeit Availability	Abmessungen [mm] Dimensions [mm]				
					L	IC	S	D1	RE
	WNEX 040304-MP	BCP20M	5145419	●	4	6,7	3,97	3,2	0,4
	WNEX 040304-MP	BCP25M	5125085	●	4	6,7	3,97	3,2	0,4
	WNEX 040304-MP	BCP30M	5145420	○	4	6,7	3,97	3,2	0,4
	WNEX 040304-MP	BCP35M	5125086	●	4	6,7	3,97	3,2	0,4
	WNEX 040304-MM	BCM35M	5125087	●	4	6,7	3,97	3,2	0,4
	WNEX 040304-MM	BCM40M	5145421	●	4	6,7	3,97	3,2	0,4
	WNEX 040304-MK	BCK15M	5145422	○	4	6,7	3,97	3,2	0,4
	WNEX 040304-MK	BCK20M	5125088	●	4	6,7	3,97	3,2	0,4
	WNEX 040304-MH	BCH05M	5145423	○	4	6,7	3,97	3,2	0,4
	WNEX 040304-MH	BCH10M	5145424	●	4	6,7	3,97	3,2	0,4
	WNEX 040308-MP	BCP25M	5166013	○	4	6,7	3,97	3,2	0,8
	WNEX 040308-MP	BCP35M	5166014	●	4	6,7	3,97	3,2	0,8
	WNEX 040308-MM	BCM35M	5166015	○	4	6,7	3,97	3,2	0,8
	WNEX 040308-MM	BCM40M	5166016	●	4	6,7	3,97	3,2	0,8
	WNEX 040308-MK	BCK20M	5166017	●	4	6,7	3,97	3,2	0,8
	WNEX040308-MH	BCH10M	5166018	●	4	6,7	3,97	3,2	0,8

CEDC = 6

Bestellbeispiel Order example: 10 Stück piece 5145419 oder or WNEX 040304-MP BCP20M

Aufsteckfräser 90° / WN.. 08 Face milling cutter 90° / WN.. 08

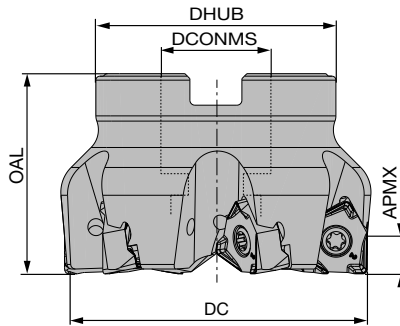

Abmessungen [mm] Dimensions [mm]						Artikelbezeichnung Item code	Bestell-Nr. Ordering No.	Verfügbarkeit Availability	Ersatzteile Spare parts	
DC	DCONMS	DHUB	OAL	APMX	ZEFF [☆]				Spannschraube Fixation screw AP02-40054 5085714 M _A = 3Nm	Torx-Schlüssel Torque wrench IP15 5088520
40	16	36	40	7	4	BF90 WN08.040 Z04	5127243	●		
50	22	46	40	7	4	BF90 WN08.050 Z04	5127244	●		
50	22	46	40	7	5	BF90 WN08.050 Z05	5107256	●		
63	22	47	40	7	6	BF90 WN08.063 Z06	5107258	●		
63	22	47	40	7	7	BF90 WN08.063 Z07	5127245	○		
80	27	62	50	7	7	BF90 WN08.080 Z07	5107260	●		
80	27	62	50	7	9	BF90 WN08.080 Z09	5127246	○		
100	32	78	50	7	8	BF90 WN08.100 Z08	5107261	●		
100	32	78	50	7	10	BF90 WN08.100 Z10	5127247	○		
125	40	90	63	7	10	BF90 WN08.125 Z10	5107263	●		
125	40	90	63	7	11	BF90 WN08.125 Z11	5127248	○		
160	40	90	63	7	11	BF90 WN08.160 Z11	5107265	●		
160	40	90	63	7	12	BF90 WN08.160 Z12	5127249	○		

Bestellbeispiel Order example: 1 Stück piece 5127243 oder or BF90 WN08.040 Z03

Aufsteckfräser 90° / WN.. 08 / INCH
Face milling cutter 90° / WN.. 08 / INCH

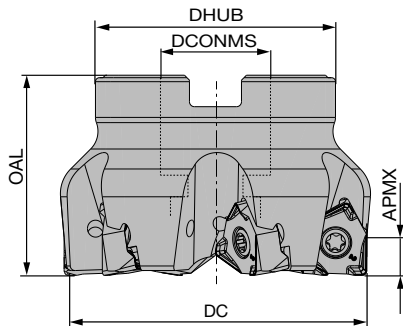

Abmessungen [INCH] Dimensions [INCH]						Artikelbezeichnung Item code	Bestell-Nr. Ordering No.	Verfügbarkeit Availability	Ersatzteile Spare parts	
DC	DCONMS	DHUB	OAL	APMX	ZEFF [☆]					
2.0	0.75	1.75	1.50	0.276	5	BFU90 WN08.2000 Z05	5132850	○		
2.5	1.00	2.25	1.75	0.276	6	BFU90 WN08.2500 Z06	5132851	○		
3.0	1.00	2.25	1.75	0.276	7	BFU90 WN08.3000 Z07	5132852	○		
4.0	1.50	3.75	2.25	0.276	8	BFU90 WN08.4000 Z08	5132853	○		
5.0	1.50	3.75	2.50	0.276	10	BFU90 WN08.5000 Z10	5132854	○		
6.0	1.50	3.75	2.50	0.276	11	BFU90 WN08.6000 Z11	5132855	○		

Bestellbeispiel Order example: 1 Stück piece 5132850 oder or BFU90 WN08.2000 Z05

CEDC = Anzahl der Schneidkanten CEDC = Number of cutting edges	Artikelbezeichnung Item code	Schneidstoffsorte Cutting materials	Bestell-Nr. Ordering No.	Verfügbarkeit Availability	Abmessungen [mm] Dimensions [mm]					
					L	IC	S	D1	RE	
	WNEX 080608-RP	BCP20M	5142996	●	8	12,7	6,55	4,6	0,8	
	WNEX 080608-RP	BCP25M	5099627	●	8	12,7	6,55	4,6	0,8	
	WNEX 080608-RP	BCP30M	5142997	●	8	12,7	6,55	4,6	0,8	
	WNEX 080608-RP	BCP35M	5098314	●	8	12,7	6,55	4,6	0,8	
	WNEX 080608-RP	BCP40M	5142998	●	8	12,7	6,55	4,6	0,8	
	WNEX 080608-RM	BCM35M	5099629	●	8	12,7	6,55	4,6	0,8	
	WNEX 080608-RM	BCM40M	5117593	●	8	12,7	6,55	4,6	0,8	
	WNEX 080608-RK	BCK15M	5142999	●	8	12,7	6,55	4,6	0,8	
	WNEX 080608-RK	BCK20M	5104081	●	8	12,7	6,55	4,6	0,8	
	WNEX 080608-MN	BCN10M	5117591	●	8	12,7	6,55	4,6	0,8	
	WNEX 080608-MN	BWN10M	5117589	●	8	12,7	6,55	4,6	0,8	
	WNEX 080608-MH	BCH05M	5143000	●	8	12,7	6,55	4,6	0,8	
	WNEX 080608-MH	BCH10M	5143003	●	8	12,7	6,55	4,6	0,8	
	WNEX 080608-MH	BCH30M	5174381	○	8	12,7	6,55	4,6	0,8	
	WNEX 080612-RP	BCP25M		5166020	○	8	12,7	6,55	4,6	1,2
	WNEX 080612-RP	BCP35M		5166021	●	8	12,7	6,55	4,6	1,2
	WNEX 080612-RM	BCM35M		5166022	○	8	12,7	6,55	4,6	1,2
	WNEX 080612-RM	BCM40M		5166023	●	8	12,7	6,55	4,6	1,2
WNEX 080612-RK	BCK20M		5166024	●	8	12,7	6,55	4,6	1,2	
WNEX 080612-MH	BCH10M		5166025	○	8	12,7	6,55	4,6	1,2	

CEDC = 6

Bestellbeispiel Order example: 10 Stück piece 5142996 oder or WNEX 080608-RP BCP20M

- Verfügbar ab Lager Available from stock
- Lieferzeit auf Anfrage Delivery time on request

Ausführung Execution	Aufsteckfräser 90° Face milling cutter 90°
	
Durchmesserbereich metrisch Diameter range metric	Ø 50 - 250 mm
Plattengröße Insert size	SN.. 12

Besondere Merkmale:

- Stabiles Eckenfräsen (Schruppen)
- Anstellwinkel 88° mit 8 Schneiden
- 0,8 oder 1,2 Eckenradius verfügbar
- Enge und sehr enge Teilung der Werkzeuge
- Ab Durchmesser 160 ohne innere Kühlmittelzufuhr
- Artikel mit Status "Lieferzeit auf Anfrage" in fünf Arbeitstagen lieferbar

Special features:

- Stable edge milling (roughing)
- Approach angle 88° with 8 cutting edges
- 0.8 or 1.2 corner radius available
- Narrow and very narrow division of the tools
- From diameter 160 no internal coolant supply
- Article with status "Delivery time on request" are deliverable in five working days

WSP Geometrie Insert geometry	SN.. 12	
	Schnitttiefe* Cutting depth* [mm] APMX max	Vorschub* Feed* [mm] f _z
MP	1,0 5,0 10,0	0,1 0,2 0,25
MM	1,0 5,0 10,0	0,1 0,18 0,22
MK	1,0 5,0 10,0	0,1 0,2 0,25

Schnittwertempfehlungen siehe Seite 130
Cutting data recommendations page 130

* Angegebene Schnittdaten sind als Richtwert zu sehen, welche durch Versuche für jeden Anwendungsfall separat optimiert werden können.
* Recommended cutting data has to be seen as a reference which can be optimised for each application through trials separately.

Aufsteckfräser 88° / SN.. 12
Face milling cutter 88° / SN.. 12

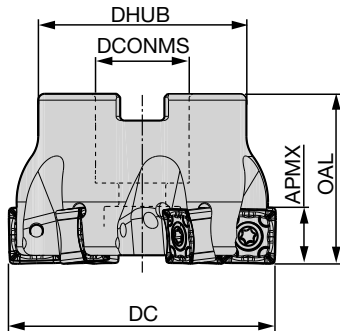

Abmessungen [mm] Dimensions [mm]						Artikelbezeichnung Item code	Bestell-Nr. Ordering No.	Verfügbarkeit Availability	Ersatzteile Spare parts	
DC	DCONMS	DHUB	OAL	APMX	ZEFF				Spannschraube Fixation screw AP06-40115 5131917 M _A = 5Nm	Torx-Schlüssel Torque wrench IP20 5088521
50	22	42	40	10	4	BF88 SN12.050 Z04	5079198	○		
63	22	49	40	10	6	BF88 SN12.063 Z06	5079199	○		
63	27	58	50	10	6	BF88 SN12.063 Z06 DA27	5156240	○		
80	27	60	50	10	7	BF88 SN12.080 Z07	5079200	○		
80	27	60	50	10	9	BF88 SN12.080 Z09	5085875	○		
100	32	80	50	10	8	BF88 SN12.100 Z08	5079201	○		
100	32	80	50	10	11	BF88 SN12.100 Z11	5085876	○		
125	40	95	63	10	10	BF88 SN12.125 Z10	5079202	○		
125	40	95	63	10	14	BF88 SN12.125 Z14	5085877	○		
160	40	115	63	10	12	BF88 SN12.160 Z12 NC	5085879	○		
160	40	115	63	10	18	BF88 SN12.160 Z18 NC	5085880	○		
200	60	164	63	10	14	BF88 SN12.200 Z14 NC	5085881	○		
200	60	164	63	10	22	BF88 SN12.200 Z22 NC	5085882	○		
250	60	184	63	10	16	BF88 SN12.250 Z16 NC	5085883	○		
250	60	184	63	10	24	BF88 SN12.250 Z24 NC	5085884	○		

Bestellbeispiel Order example: 1 Stück piece 5079198 oder or BF88 SN12.050 Z04

NC = Keine Kühlung / no coolant

CEDC = Anzahl der Schneidkanten CEDC = Number of cutting edges	Artikelbezeichnung Item code	Schneidstoffsorte Cutting materials	Bestell-Nr. Ordering No.	Verfügbarkeit Availability	Abmessungen [mm] Dimensions [mm]					
					L	IC	S	D1	RE	
 CEDC = 8	SNMX 120608 SN-MP	BPC30M	5081873	●	12,70	12,70	5,8	5,2	0,8	
	SNMX 120608 SN-MP	BPC35M	5081014	●	12,70	12,70	5,8	5,2	0,8	
	SNMX 120608 SN-MM	BCM40M	5081871	●	12,70	12,70	6,2	5,2	0,8	
	SNMX 120608 SN-MK	BCK15M	5085128	●	12,70	12,70	5,8	5,2	0,8	
	SNMX 120608 SN-MK	BCK20M	5081875	●	12,70	12,70	5,8	5,2	0,8	
	SNMX 120612 SN-MP	BPC30M	5085133	●	12,70	12,70	5,8	5,2	1,2	
	SNMX 120612 SN-MP	BPC35M	5085131	●	12,70	12,70	5,8	5,2	1,2	
	SNMX 120612 SN-MK	BCK15M	5085136	●	12,70	12,70	5,8	5,2	1,2	
	SNMX 120612 SN-MK	BCK20M	5085135	●	12,70	12,70	5,8	5,2	1,2	

Bestellbeispiel Order example: 10 Stück piece 5081873 oder or SNMX 120608 SN-MP BPC30M

- Verfügbar ab Lager Available from stock
- Lieferzeit auf Anfrage Delivery time on request

Schnittwertempfehlung für Fräser 90°
Cutting data recommendations for Milling Cutter 90°

ISO 513	BZG	Kühlung Cooling			Schnittdaten v _c [m/min] Cutting data v _c [m/min]			
		MMS/Luft MMS/Air	Trocken Dry	Nass Wet	BCP20M BCP25M	BCP30M BCP35M BCP40M	BCM35M	BCM40M
		Vc = m/min						
P	P1	●	●		210 - 290	180 - 260	---	200 - 260
	P2	●	●		170 - 250	160 - 200	---	160 - 220
	P3	●	●		140 - 190	120 - 160	---	130 - 170
	P4	●	●		120 - 160	110 - 150	---	120 - 150
	P5	●	●		140 - 200	120 - 170	---	130 - 190
M	M1	●	●	●	100 - 150	---	120 - 180	110 - 160
	M2	●	●	●	70 - 110	---	80 - 130	70 - 120
K	K1	●	●		200 - 280	---	---	---
	K2	●	●		130 - 180	---	---	---
	K3	●	●		160 - 210	---	---	---
N	N1	●	●	●	---	---	---	---
	N2	●	●	●	---	---	---	---
	N3	●	●	●	---	---	---	---
	N4	●	●	●	---	---	---	---
S	S1	●	●	●	---	---	70 - 90	55 - 70
	S2	●	●	●	---	---	35 - 45	25 - 35
	S3	●	●	●	---	---	50 - 100	30 - 70
	S4	●	●	●	---	---	30 - 80	25 - 50
H	H1	45 - 54 HRC	●	●	---	---	100 - 140	---
	H2	55 - 63 HRC	●	●	---	---	80 - 120	---
	H3	64 - 66 HRC	●	●	---	---	---	---
	H4	50 - 60 HRC	●	●	---	---	90 - 130	---

- empfohlene Anwendung recommended application
- alternative Anwendung um 30 - 50 % reduzieren
alternative application reduced by 30 - 50 %

Schnittdaten v _c [m/min] Cutting data v _c [m/min]					
	BCK15M BCK20M	BWN10M	BCN10M	BCS35M BCS40M	BCH05M BCH10M BCH30M
	220 - 280	---	---	---	240 - 350
	190 - 240	---	---	---	200 - 300
	150 - 190	---	---	---	160 - 250
	---	---	---	---	---
	140 - 200	---	---	---	160 - 260
	---	---	---	100 - 150	---
	---	---	---	70 - 110	---
	220 - 360	---	---	---	280 - 490
	150 - 190	---	---	---	160 - 300
	170 - 240	---	---	---	220 - 340
	---	1200 - 2400	1500 - 3000	---	---
	---	240 - 550	310 - 750	---	---
	---	120 - 380	160 - 480	---	---
	---	400 - 500	600 - 800	---	---
	---	---	---	65 - 80	---
	---	---	---	30 - 45	---
	---	---	---	40 - 90	---
	---	---	---	30 - 70	---
	100 - 140	---	---	---	110 - 160
	80 - 120	---	---	---	90 - 130
	---	---	---	---	70 - 110
	90 - 130	---	---	---	100 - 150

BALLtec / TORROtec



- Kugelkopierwerkzeuge für die Semifinish- und die Finishbearbeitung
- Ball nose copying tool for semi finishing and finishing

3D Fräsen
3D Milling

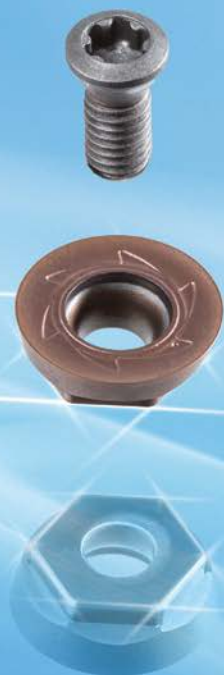
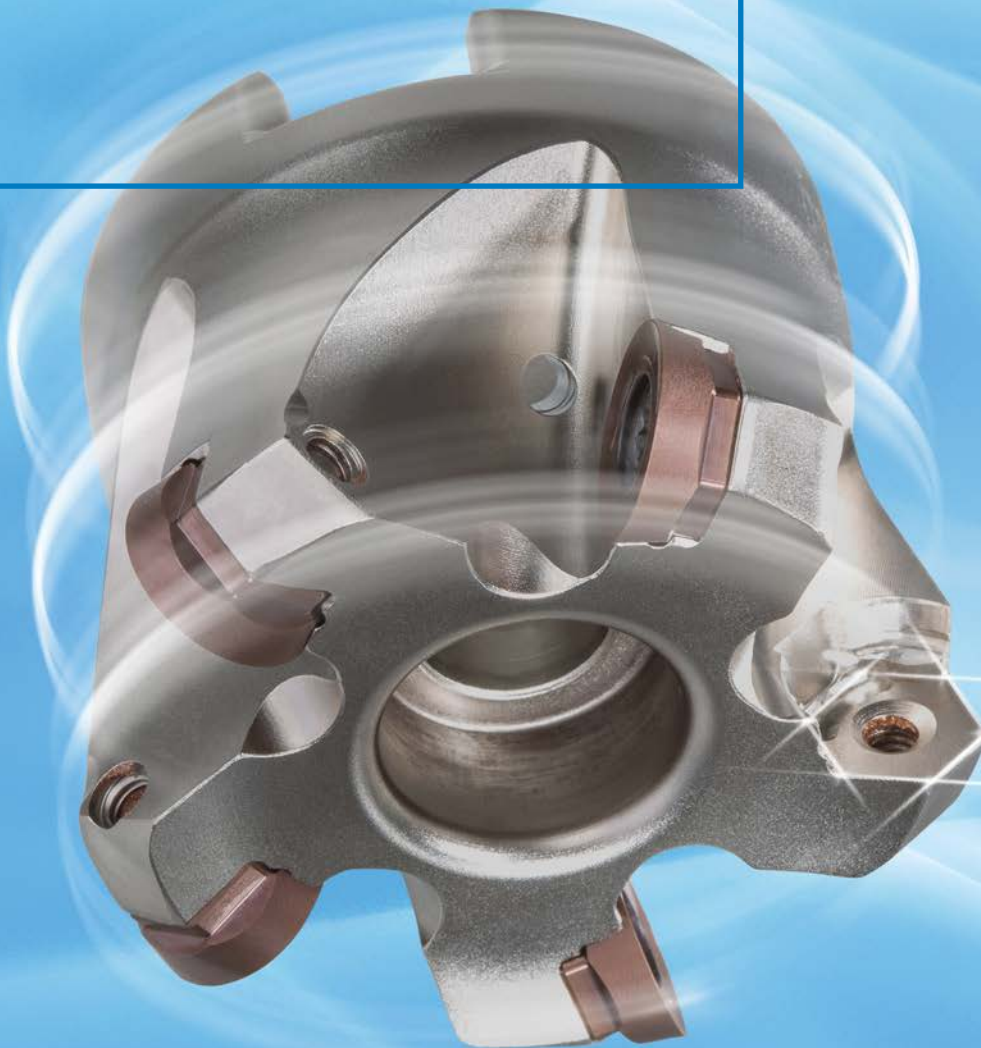

	Schafffräser Stahlschaft End milling cutter steel shank	Schafffräser Vollhartmetall End milling cutter solid carbide shank	Einschraubfräser Stahlschaft Screw on type steelshank
Ausführung Execution			
Durchmesserbereich metrisch Diameter range metric	Ø 8 - 25 mm	Ø 8 - 32 mm	Ø 8 - 32 mm
Plattengröße BE Insert size BE	08, 10, 12, 16, 20, 25	08, 10, 12, 16, 20, 25, 32	08, 10, 12, 16, 20, 25, 32
Plattengröße TE Insert size TE	08, 10, 12, 16, 20, 25	08, 10, 12, 16, 20, 25	08, 10, 12, 16, 20, 25

Besondere Merkmale:

- Multifunktionales Werkzeugsystem für höchste Produktivität
- 1 Grundkörper für 2 Bearbeitungsverfahren = Multifunktional
- Einsparung von Trägerwerkzeugen durch multifunktionales Werkzeugsystem
- TORROtec: Bei höchsten Anforderungen hinsichtlich Präzision und Prozessstabilität wird empfohlen TORROtec WSP mit den neuen speziell designten Trägerwerkzeugen zu kombinieren (siehe Seite 57-58)
- Kugelkopierwerkzeuge für die Semifinish- und die Finishbearbeitung
- Variantenvielfalt bei Wendepplatten und Trägerwerkzeugen
- Schwingungsdämpfende, gelötete VHM Werkzeuge bei der Finishbearbeitung für hochqualitative Oberflächen
- Präzise Rotationstoleranzen
- Verwendung von Ultrafeinkorn-Hartmetallen für hohe Verschleißbeständigkeit bei gleichzeitig hoher Bruchbeständigkeit – für mehr Prozesssicherheit.
- Innere Kühlmittelzufuhr mit jeder Platten / Trägerwerkzeugkombination sichergestellt
- Hohe Plattenstärke für gute Stabilität und Vibrationsresistenz

Special features:

- Multifunctional tool system for highest productivity
- 1 basic body for 2 machining processes = multifunctional
- Saving of tool holders due to multifunctional tool system
- TORROtec: for highest requirements concerning precision and process stability we recommend to combine TORROtec inserts with the new special designed tools (see page 57-58)
- Ball nose copying tool for semi finishing and finishing
- Wide variety of inserts and tools
- Vibrations reducing, soldered solid carbide tools for finishing of high quality surfaces
- Specific rotation tolerances
- Application of ultrafine grain carbides for high wear resistance and at the same time high fracture resistance – for more process reliability
- Internal coolant supply with each insert / cutter body guaranteed
- Higher thickness on inserts for more stability and vibration resistance

WSP Geometrie Insert geometry	BE.. 08		BE.. 10	
	Schnitttiefe* Cutting depth* [mm] APMX max	Vorschub* Feed* [mm] f _z	Schnitttiefe* Cutting depth* [mm] APMX max	Vorschub* Feed* [mm] f _z
FHF2	0,10 0,15 0,20	0,10 0,15 0,20	0,12 0,20 0,24	0,15 0,20 0,25
MHN	0,10 0,15 0,20	0,10 0,15 0,20	0,12 0,20 0,24	0,15 0,20 0,25
MHN2	0,10 0,15 0,20	0,10 0,15 0,20	0,12 0,20 0,24	0,15 0,20 0,25
SHN2	0,10 0,12 0,15	0,08 0,12 0,15	0,10 0,15 0,20	0,10 0,15 0,20

WSP Geometrie Insert geometry	BE.. 12		BE.. 16		BE.. 20	
	Schnitttiefe* Cutting depth* [mm] APMX max	Vorschub* Feed* [mm] f _z	Schnitttiefe* Cutting depth* [mm] APMX max	Vorschub* Feed* [mm] f _z	Schnitttiefe* Cutting depth* [mm] APMX max	Vorschub* Feed* [mm] f _z
FHF	0,06 0,12 0,18	0,08 0,14 0,20	0,08 0,15 0,22	0,12 0,18 0,24	0,12 0,20 0,28	0,18 0,24 0,30
FHF2	0,06 0,12 0,18	0,08 0,14 0,20	0,08 0,15 0,22	0,12 0,18 0,24	0,12 0,20 0,28	0,18 0,24 0,30
MHF	0,10 0,15 0,24	0,15 0,22 0,30	0,08 0,15 0,22	0,12 0,18 0,24	0,20 0,25 0,40	0,22 0,30 0,38
SHF	0,15 0,25 0,30	0,15 0,25 0,30	0,13 0,20 0,32	0,18 0,25 0,30	0,20 0,35 0,45	0,30 0,40 0,45
FHN2	0,06 0,12 0,18	0,08 0,14 0,20	0,20 0,30 0,35	0,20 0,30 0,35	0,12 0,20 0,28	0,18 0,24 0,30
MHN	0,15 0,30 0,40	0,15 0,25 0,35	0,20 0,35 0,45	0,20 0,30 0,35	0,25 0,40 0,50	0,30 0,40 0,45
MHN2	0,15 0,30 0,40	0,15 0,25 0,35	0,20 0,35 0,45	0,20 0,30 0,35	0,25 0,40 0,50	0,30 0,40 0,45
SHN	0,10 0,16 0,22	0,10 0,16 0,22	0,12 0,18 0,24	0,14 0,20 0,26	0,16 0,24 0,32	0,20 0,28 0,36
SHN2	0,10 0,16 0,22	0,10 0,16 0,22	0,12 0,18 0,24	0,14 0,20 0,26	0,16 0,24 0,32	0,20 0,28 0,36

WSP Geometrie Insert geometry	BE.. 25		BE.. 32	
	Schnitttiefe* Cutting depth* [mm] APMX max	Vorschub* Feed* [mm] f _z	Schnitttiefe* Cutting depth* [mm] APMX max	Vorschub* Feed* [mm] f _z
FHF2	0,18 0,25 0,38	0,15 0,22 0,32	0,22 0,29 0,42	0,18 0,27 0,35
MHF	0,25 0,31 0,50	0,22 0,32 0,42	0,32 0,40 0,64	0,25 0,35 0,45
SHF	0,25 0,40 0,50	0,30 0,40 0,45	0,30 0,45 0,55	0,40 0,50 0,55
MHN	0,30 0,45 0,55	0,30 0,40 0,45	0,35 0,50 0,60	0,40 0,50 0,55
MHN2	0,30 0,45 0,55	0,30 0,40 0,45	-	-
SHN2	0,22 0,30 0,38	0,20 0,30 0,40	-	-

Schnittwertempfehlungen siehe Seite 174
Cutting data recommendations page 174

* Angegebene Schnittdaten sind als Richtwert zu sehen, welche durch Versuche für jeden Anwendungsfall separat optimiert werden können.
* Recommended cutting data has to be seen as a reference which can be optimised for each application through trials separately.

WSP Geometrie Insert geometry	TE.. 08		TE.. 10		TE.. 12	
	Schnitttiefe* Cutting depth* [mm] APMX max	Vorschub* Feed* [mm] f _z	Schnitttiefe* Cutting depth* [mm] APMX max	Vorschub* Feed* [mm] f _z	Schnitttiefe* Cutting depth* [mm] APMX max	Vorschub* Feed* [mm] f _z
SHF	0,10 0,20 *	0,05 0,15 0,25	0,10 0,25 *	0,08 0,17 0,25	0,10 0,30 *	0,10 0,20 0,30
MHN	0,10 0,25 *	0,10 0,20 0,3	0,10 0,30 *	0,10 0,20 0,30	0,10 0,30 *	0,10 0,20 0,35

WSP Geometrie Insert geometry	TE.. 16		TE.. 20		TE.. 25	
	Schnitttiefe* Cutting depth* [mm] APMX max	Vorschub* Feed* [mm] f _z	Schnitttiefe* Cutting depth* [mm] APMX max	Vorschub* Feed* [mm] f _z	Schnitttiefe* Cutting depth* [mm] APMX max	Vorschub* Feed* [mm] f _z
SHF	0,15 0,30 *	0,10 0,22 0,35	0,20 0,35 *	0,12 0,26 0,40	0,20 0,4 *	0,20 0,30 0,45
MHN	0,15 0,35 *	0,10 0,25 0,40	0,20 0,40 *	0,20 0,27 0,45	0,20 0,45 *	0,20 0,35 0,50

Schnittwertempfehlungen siehe Seite 174
Cutting data recommendations page 174

* Angegebene Schnittdaten sind als Richtwert zu sehen, welche durch Versuche für jeden Anwendungsfall separat optimiert werden können.
* Recommended cutting data has to be seen as a reference which can be optimised for each application through trials separately.

Schaftfräser konisch Form A / BE.. & TE..
 End milling cutter conical form A / BE.. & TE..

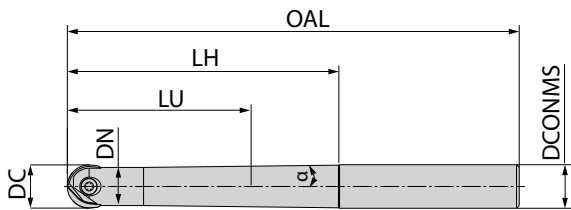





Abmessungen [mm] Dimension [mm]									Artikelbezeichnung Item code	Schaft Shank	Bestell-Nr. Ordering-No	Verfügbarkeit Availability	Ersatzteile Spare parts		
DC	DCONMS	DN	LH	LU	OAL	α	ZEFF \odot								
8	12	6,5	53	28	110	3°30'	2	BEA00 BE08.008 Z02 110 NC	HA	5117321	●	BE.. 08 TE.. 08	AP12-25063 5118702 $M_A = 1,4\text{Nm}$	IP7 5118123	
8	12	6,5	75	37	132	2°	2	BEA00 BE08.008 Z02 132 NC	HA	5117323	●				
10	12	8	53	47	110	2°20'	2	BEA00 BE10.010 Z02 110 NC	HA	5117325	●	BE.. 10 TE.. 10	AP12-30077 5118703 $M_A = 2,5\text{Nm}$	IP8 5088519	
10	12	8	75	54	132	1°15'	2	BEA00 BE10.010 Z02 132 NC	HA	5117327	●				
12	12	10	53	53	110	1°20'	2	BEA00 BE12.012 Z02 110 NC	HA	5117328	●	BE.. 12 TE.. 12	AP12-35095 5118704 $M_A = 3,5\text{Nm}$	IP10 5118726	
12	12	10	85	85	145	0°40'	2	BEA00 BE12.012 Z02 145 NC	HA	5117330	●				
16	16	14	63	63	123	1°15'	2	BEA00 BE16.016 Z02 123 NC	HA	5117331	●	BE.. 16 TE.. 16	AP12-40133 5118705 $M_A = 5\text{Nm}$	IP15 5088520	
16	16	14	100	100	166	0°40'	2	BEA00 BE16.016 Z02 166 NC	HA	5117332	●				
20	20	17	75	75	141	2°	2	BEA00 BE20.020 Z02 141 NC	HA	5117339	●	BE.. 20 TE.. 20	AP12-50162 5118706 $M_A = 7\text{Nm}$	IP20 5088521	
20	20	17	115	115	191	1°	2	BEA00 BE20.020 Z02 191 NC	HA	5117340	●				
25	25	21	90	90	166	2°	2	BEA00 BE25.025 Z02 166 NC	HA	5117341	●	BE.. 25 TE.. 25	AP12-60200 5118707 $M_A = 8\text{Nm}$	IP25 5118727	
25	32	21	135	80	215	3°	2	BEA00 BE25.025 Z02 215 NC	HA	5117343	●				

Bestellbeispiel Order example: 1 Stück piece 5117321 oder or BEA00 BE08.008.Z02 110 NC
 NC = Keine Kühlung / no coolant

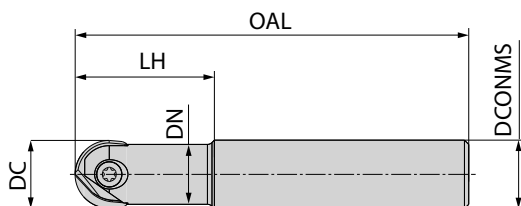
- Verfügbar ab Lager Available from stock
- kurzfristig lieferbar available at short notice
- Lieferzeit auf Anfrage Delivery time on request

Schaftfräser zylindrisch Form B / BE.. & TE..
 End milling cutter cylindrical form B / BE.. & TE..





Abmessungen [mm] Dimension [mm]						Artikelbezeichnung Item code	Schaft Shank	Bestell-Nr. Ordering-No	Verfügbarkeit Availability		Ersatzteile Spare parts	
DC	DCONMS	DN	OAL	LH	ZEFF							
8	12	7	92	32	2	BEB00 BE08.008 Z02 092	HA	5117302	●	BE.. 08 TE.. 08	AP12-25063 5118702 M _A = 1,4Nm	IP7 5118123
10	12	8,8	92	32	2	BEB00 BE10.010 Z02 092	HA	5117305	●	BE.. 10 TE.. 10	AP12-30077 5118703 M _A = 2,5Nm	IP8 5088519
12	12	10,8	92	32	2	BEB00 BE12.012 Z02 092	HA	5117310	●	BE.. 12 TE.. 12	AP12-35095 5118704 M _A = 3,5Nm	IP10 5118726
12	12	10	145	45	2	BEB00 BE12.012 Z02 145 NC	HA	5117311	●			
16	16	14,5	92	32	2	BEB00 BE16.016 Z02 092	HA	5117312	●	BE.. 16 TE.. 16	AP12-40133 5118705 M _A = 5Nm	IP15 5088520
16	16	14	160	55	2	BEB00 BE16.016 Z02 160 NC	HA	5117313	●			
20	20	17,5	104	38	2	BEB00 BE20.020 Z02 104	HA	5117315	●	BE.. 20 TE.. 20	AP12-50162 5118706 M _A = 7Nm	IP20 5088521
20	20	17	190	65	2	BEB00 BE20.020 Z02 190 NC	HA	5117317	●			
25	25	22,5	121	45	2	BEB00 BE25.025 Z02 121	HA	5117319	●	BE.. 25 TE.. 25	AP12-60200 5118707 M _A = 8Nm	IP25 5118727
25	25	21	210	75	2	BEB00 BE25.025 Z02 210 NC	HA	5117320	●			

Bestellbeispiel Order example: 1 Stück piece 5117302 oder or BEB00 BE08.008 Z02 092
 NC = Keine Kühlung / no coolant

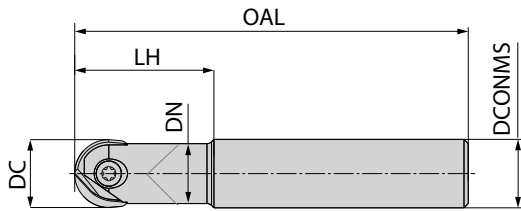
Schaftfräser zylindrisch Form B Vollhartmetall-Schaft / BE.. & TE..
End milling cutter cylindrical form B solid carbide shank / BE.. & TE..



Abmessungen [mm] Dimension [mm]						Artikelbezeichnung Item code	Schaft Shank	Bestell-Nr. Ordering-No	Verfügbarkeit Availability		Ersatzteile Spare parts	
DC	DCONMS	DN	OAL	LH	ZEFF							
8	8	7	80	25	2	CEB00 BE08.008 Z02 80	HA	5122820	●	BE.. 08 TE.. 08	AP12-25063 5118702 M _A = 1,4Nm	IP7 5118123
8	8	7	100	25	2	CEB00 BE08.008 Z02 100	HA	5122821	●			
8	8	7	150	75	2	CEB00 BE08.008 Z02 150	HA	5122822	○			
10	10	8,8	80	35	2	CEB00 BE10.010 Z02 80	HA	5122823	○	BE.. 10 TE.. 10	AP12-30077 5118703 M _A = 2,5Nm	IP8 5088519
10	10	8,8	120	35	2	CEB00 BE10.010 Z02 120	HA	5122826	●			
10	10	8,8	150	50	2	CEB00 BE10.010 Z02 150	HA	5122827	●			
12	12	10,5	80	35	2	CEB00 BE12.012 Z02 80	HA	5122828	●	BE.. 12 TE.. 12	AP12-35095 5118704 M _A = 3,5Nm	IP10 5118726
12	12	10,5	120	35	2	CEB00 BE12.012 Z02 120	HA	5122829	●			
12	12	10,5	160	50	2	CEB00 BE12.012 Z02 160	HA	5122830	●			
16	16	14	100	40	2	CEB00 BE16.016 Z02 100	HA	5122831	●	BE.. 16 TE.. 16	AP12-40133 5118705 M _A = 5Nm	IP15 5088520
16	16	14	140	40	2	CEB00 BE16.016 Z02 140	HA	5122832	●			
16	16	14	140	55	2	CEB00 BE16.016 Z02 140 55	HA	5136613	○			
16	16	14	175	55	2	CEB00 BE16.016 Z02 175	HA	5122833	●			
20	20	18	100	50	2	CEB00 BE20.020 Z02 100	HA	5122834	○	BE.. 20 TE.. 20	AP12-50162 5118706 M _A = 7Nm	IP20 5088521
20	20	18	140	50	2	CEB00 BE20.020 Z02 140	HA	5122835	●			
20	20	18	190	75	2	CEB00 BE20.020 Z02 190	HA	5122836	●			
25	25	22,4	160	60	2	CEB00 BE25.025 Z02 160	HA	5122837	○	BE.. 25 TE.. 25	AP12-60200 5118707 M _A = 8Nm	IP25 5118727
25	25	22,4	210	90	2	CEB00 BE25.025 Z02 210	HA	5122838	●			
32	32	28,6	190	65	2	CEB00 BE32.032 Z02 190	HA	5122839	○	BE.. 32 TE.. 32	AP12-80250 5118709 M _A = 20Nm	IP40 5118728
32	32	28,6	240	105	2	CEB00 BE32.032 Z02 240	HA	5122840	○			

- Verfügbar ab Lager Available from stock
- kurzfristig lieferbar available at short notice
- Lieferzeit auf Anfrage Delivery time on request

Bestellbeispiel Order example: 1 Stück piece 5122820 oder or CEB00 BE08.008 Z02 80

Einschraubfräser / BE.. & TE.. Screw on type / BE.. & TE..

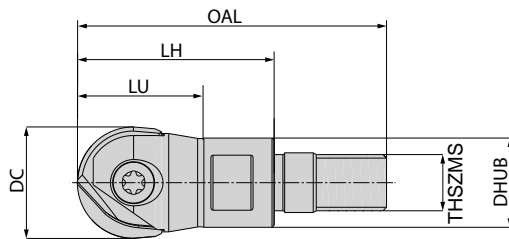

Abmessungen [mm] Dimension [mm]							Artikelbezeichnung Item code	Bestell-Nr. Ordering No.	Verfügbarkeit Availability	Ersatzteile Spare parts		
DC	DHUB	OAL	LH	LU	THSZMS	ZEFF [⊙]						
8	7,7	36	23	23	4,5	2	BS00 BE08.008 Z02 077 M4.5	5136986	○	BE.. 08 TE.. 08	AP12-25063 5118702 M _A = 1,4Nm	IP7 5118123
8	9,7	36,5	23	13*	6	2	BS00 BE08.008 Z02 M6	5117344	●			
10	9,7	36,5	23	23	6	2	BS00 BE10.010 Z02 M6	5117345	●	BE.. 10 TE.. 10	AP12-30077 5118703 M _A = 2,5Nm	IP8 5088519
12	9,7	36,5	23	23	6	2	BS00 BE12.012 Z02 M6	5117347	●	BE.. 12 TE.. 12	AP12-35095 5118704 M _A = 3,5Nm	IP10 5118726
12	12,7	44	28	19*	8	2	BS00 BE12.012 Z02 M8	5117348	●			
16	12,7	44	28	28	8	2	BS00 BE16.016 Z02 M8	5117349	●	BE.. 16 TE.. 16	AP12-40133 5118705 M _A = 5Nm	IP15 5088520
16	15,4	47	28	28	10	2	BS00 BE16.016 Z02 M10	5117350	●			
20	17,7	46	28	28	10	2	BS00 BE20.020 Z02 M10	5117351	●	BE.. 20 TE.. 20	AP12-50162 5118706 M _A = 7Nm	IP20 5088521
25	20,7	55	35	35	12	2	BS00 BE25.025 Z02 M12	5117372	●	BE.. 25 TE.. 25	AP12-60200 5118707 M _A = 8Nm	IP25 5118727
32	28,7	65	43	43	16	2	BS00 BE32.032 Z02 M16	5117373	●	BE.. 32 TE.. 32	AP12-80250 5118709 M _A = 20Nm	IP40 5118728

* max. Einsatzlänge in mm
max. application length in mm

Die passenden Hartmetallverlängerungen finden Sie auf Seite 294
You will find the matching carbide extensions on page 294

N = Anzahl der Schneidkanten N = Number of cutting edges	Artikelbezeichnung Item code	Schneidstoffsorte Cutting materials	Bestell-Nr. Ordering-No	Verfügbarkeit Availability	Abmessungen [mm] Dimensions [mm]		
					IC	S	D1
	BE12-SHF	BCH10M	5117378	●	12	2,99	3,5
	BE12-SHF	BCH23M	5117382	○	12	2,99	3,5
	BE12-MHF	BCH30M	5117384	●	12	2,99	3,5
	BE16-SHF	BCH10M	5117356	●	16	3,99	4
	BE16-SHF	BCH23M	5117364	●	16	3,99	4
	BE16-MHF	BCH30M	5117365	●	16	3,99	4
	BE20-SHF	BCH10M	5117681	●	20	4,99	5
	BE20-SHF	BCH23M	5117682	●	20	4,99	5
	BE20-MHF	BCH30M	5117683	●	20	4,99	5
	BE25-SHF	BCH10M	5117684	○	25	5,99	6
	BE25-SHF	BCH23M	5117485	○	25	5,99	6
	BE25-MHF	BCH30M	5117488	●	25	5,99	6
	BE32-SHF	BCH10M	5117494	●	32	6,99	8
	BE32-SHF	BCH23M	5117496	⦿	32	6,99	8
	BE32-MHF	BCH30M	5117499	⦿	32	6,99	8

CEDC = 2

- Verfügbar ab Lager Available from stock
- ⦿ kurzfristig lieferbar available at short notice
- Lieferzeit auf Anfrage Delivery time on request

Bestellbeispiel Order example: 10 Stück pieces 5117377 oder or BE12-FHF BCH03M

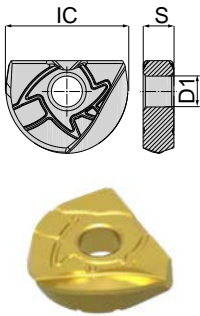
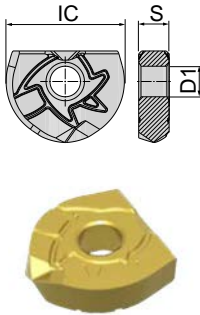
N = Anzahl der Schneidkanten N = Number of cutting edges	Artikelbezeichnung Item code	Schneidstoffsorte Cutting materials	Bestell-Nr. Ordering No.	Verfügbarkeit Availability	Abmessungen [mm] Dimensions [mm]		
					IC	S	D1
	BE08-FHF2	BCH13M	5155325	●	8	2,39	2,5
	BE10-FHF2	BCH13M	5155327	●	10	2,59	3
	BE12-FHF2	BCH13M	5155330	●	12	2,99	3,5
	BE16-FHF2	BCH13M	5154846	●	16	3,99	4
	BE20-FHF2	BCH13M	5155331	●	20	4,99	5
	BE25-FHF2	BCH13M	5168770	●	25	5,99	6
	BE32-FHF2	BCH13M	5165828	●	32	6,99	8
CEDC = 2							
	BE08-MHN2	BCH10M	5133146	●	8	2,39	2,5
	BE08-SHN2	BCH23M	5133147	●	8	2,39	2,5
	BE08-MHN2	BCH30M	5133148	●	8	2,39	2,5
	BE10-MHN2	BCH10M	5133149	●	10	2,59	3
	BE10-SHN2	BCH23M	5133150	●	10	2,59	3
	BE10-MHN2	BCH30M	5133151	●	10	2,59	3
	BE12-FHN2	BCH03M	5131968	●	12	2,99	3,5
	BE12-MHN2	BCH10M	5131970	●	12	2,99	3,5
	BE12-SHN2	BCH23M	5131971	●	12	2,99	3,5
	BE12-MHN2	BCH30M	5131973	○	12	2,99	3,5
	BE16-MHN2	BCH10M	5131975	●	16	3,99	4
	BE16-SHN2	BCH23M	5131976	○	16	3,99	4
	BE16-MHN2	BCH30M	5131977	○	16	3,99	4
	BE20-MHN2	BCH10M	5133152	●	20	4,99	5
	BE20-SHN2	BCH23M	5133153	○	20	4,99	5
	BE20-MHN2	BCH30M	5133154	●	20	4,99	5
	BE25-MHN2	BCH10M	5133155	○	25	5,99	6
	BE25-SHN2	BCH23M	5133156	○	25	5,99	6
	BE25-MHN2	BCH30M	5133157	●	25	5,99	6
	BE32-MHN2	BCH10M	5144243	○	32	6,99	8
BE32-SHN2	BCH23M	5144244	●	32	6,99	8	
BE32-MHN2	BCH30M	5144245	○	32	6,99	8	
CEDC = 2							

N = Anzahl der Schneidkanten N = Number of cutting edges	Artikelbezeichnung Item code	Schneidstoffsorte Cutting materials	Bestell-Nr. Ordering No.	Verfügbarkeit Availability	Abmessungen [INCH] Dimensions [INCH]		
					IC	S	D1
 	BE0312-SHF	BCH10M	5151437	○	0.312	0.094	0.098
	BE0312-SHF	BCH23M	5151438	○	0.312	0.094	0.098
	BE0312-MHF	BCH30M	5151439	○	0.312	0.094	0.098
 	BE0375-SHF	BCH10M	5151443	●	0.375	0.100	0.118
	BE0375-SHF	BCH23M	5151444	●	0.375	0.100	0.118
	BE0375-MHF	BCH30M	5151445	○	0.375	0.100	0.118
	BE0500-SHF	BCH10M	5151454	●	0.500	0.118	0.138
	BE0500-SHF	BCH23M	5151455	●	0.500	0.118	0.138
	BE0500-MHF	BCH30M	5151456	○	0.500	0.118	0.138
	BE0625-SHF	BCH10M	5151462	○	0.625	0.157	0.157
	BE0625-SHF	BCH23M	5151463	○	0.625	0.157	0.157
	BE0625-MHF	BCH30M	5151464	○	0.625	0.157	0.157
	BE0750-SHF	BCH10M	5147176	●	0.750	0.196	0.196
	BE0750-SHF	BCH23M	5147177	○	0.750	0.196	0.196
	BE0750-MHF	BCH30M	5147178	○	0.750	0.196	0.196
	BE1000-SHF	BCH10M	5151469	●	1.000	0.236	0.236
	BE1000-SHF	BCH23M	5151470	●	1.000	0.236	0.236
	BE1000-MHF	BCH30M	5151471	○	1.000	0.236	0.236
BE1250-SHF	BCH10M	5151475	○	1.250	0.275	0.315	
BE1250-SHF	BCH23M	5151476	○	1.250	0.275	0.315	
BE1250-MHF	BCH30M	5151477	○	1.250	0.275	0.315	
CEDC = 2							
 	BE0312-FHF2	BCH13M	5156144	○	0.312	0.094	0.098
	BE0375-FHF2	BCH13M	5156147	○	0.375	0.100	0.118
	BE0500-FHF2	BCH13M	5156148	○	0.500	0.118	0.138
	BE0625-FHF2	BCH13M	5156160	○	0.625	0.157	0.157
	BE0750-FHF2	BCH13M	5156161	○	0.750	0.196	0.196
CEDC = 2							

- Verfügbar ab Lager Available from stock
- ⦿ kurzfristig lieferbar available at short notice
- Lieferzeit auf Anfrage Delivery time on request

Bestellbeispiel Order example: 10 Stück pieces 5151437 oder or BE0312-SHF BCH10M

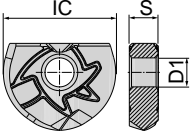
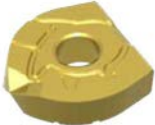
N = Anzahl der Schneidkanten N = Number of cutting edges	Artikelbezeichnung Item code	Schneidstoffsorte Cutting materials	Bestell-Nr. Ordering No.	Verfügbarkeit Availability	Abmessungen [INCH] Dimensions [INCH]		
					IC	S	D1
 	BE0312-MHN2	BCH10M	5151440	○	0.312	0.094	0.098
	BE0312-SHN2	BCH23M	5151441	○	0.312	0.094	0.098
	BE0312-MHN2	BCH30M	5151442	○	0.312	0.094	0.098
	BE0375-MHN2	BCH10M	5151447	●	0.375	0.10	0.118
	BE0375-SHN2	BCH23M	5151448	●	0.375	0.10	0.118
	BE0375-MHN2	BCH30M	5151449	○	0.375	0.10	0.118
	BE0500-MHN2	BCH10M	5151458	●	0.500	0.118	0.138
	BE0500-SHN2	BCH23M	5151459	●	0.500	0.118	0.138
	BE0500-MHN2	BCH30M	5151460	○	0.500	0.118	0.138
	BE0625-MHN2	BCH10M	5151466	○	0.625	0.157	0.157
	BE0625-SHN2	BCH23M	5151467	○	0.625	0.157	0.157
	BE0625-MHN2	BCH30M	5151468	○	0.625	0.157	0.157
	BE0750-MHN2	BCH10M	5147179	○	0.750	0.196	0.196
	BE0750-SHN2	BCH23M	5147180	○	0.750	0.196	0.196
	BE0750-MHN2	BCH30M	5147181	○	0.750	0.196	0.196
	BE1000-MHN2	BCH10M	5151472	●	1.000	0.236	0.236
	BE1000-SHN2	BCH23M	5151473	●	1.000	0.236	0.236
	BE1000-MHN2	BCH30M	5151474	○	1.000	0.236	0.236
	BE1250-MHN2	BCH10M	5151478	○	1.250	0.275	0.315
	BE1250-SHN2	BCH23M	5151479	○	1.250	0.275	0.315
BE1250-MHN2	BCH30M	5151480	○	1.250	0.275	0.315	

CEDC = 2

Schaftfräser zylindrisch Form B Vollhartmetall-Schaft / TE..
End milling cutter cylindrical form B Solid carbide shank / TE..

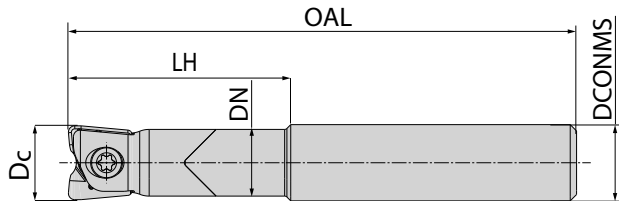

Abmessungen [mm] Dimension [mm]						Artikelbezeichnung Item code	Schaft Shank	Bestell-Nr. Ordering-No	Verfügbarkeit Availability		Ersatzteile Spare parts	
DC	DCONMS	DN	LH	OAL	ZEFF [⊙]							
8	8	7	25	80	2	CEB90 TE08.008 Z02 80	HA	5149510	●	TE.. 08	AP12-25063 5118702 M _A = 1,4Nm	IP7 5118123
8	8	7	25	100	2	CEB90 TE08.008 Z02 100	HA	5149511	●			
8	8	7	75	150	2	CEB90 TE08.008 Z02 150	HA	5149512	○			
10	10	8,8	35	80	2	CEB90 TE10.010 Z02 80	HA	5149528	○	TE.. 10	AP12-30077 5118703 M _A = 2,5Nm	IP8 5088519
10	10	8,8	35	120	2	CEB90 TE10.010 Z02 120	HA	5149513	●			
10	10	8,8	50	150	2	CEB90 TE10.010 Z02 150	HA	5149514	●			
12	12	10,5	35	80	2	CEB90 TE12.012 Z02 80	HA	5149515	●	TE.. 12	AP12-35095 5118704 M _A = 3,5Nm	IP10 5118726
12	12	10,5	35	120	2	CEB90 TE12.012 Z02 120	HA	5149516	●			
12	12	10,5	50	160	2	CEB90 TE12.012 Z02 160	HA	5149517	●			
16	16	14	40	100	2	CEB90 TE16.016 Z02 100	HA	5149518	●	TE.. 16	AP12-40133 5118705 M _A = 5Nm	IP15 5088520
16	16	14	40	140	2	CEB90 TE16.016 Z02 140	HA	5149519	●			
16	16	14	55	140	2	CEB90 TE16.016 Z02 140 55	HA	5149529	○			
16	16	14	55	175	2	CEB90 TE16.016 Z02 175	HA	5149520	●			
20	20	18	50	100	2	CEB90 TE20.020 Z02 100	HA	5149521	○	TE.. 20	AP12-50162 5118706 M _A = 7Nm	IP20 5088521
20	20	18	50	140	2	CEB90 TE20.020 Z02 140	HA	5149522	●			
20	20	18	75	190	2	CEB90 TE20.020 Z02 190	HA	5149523	●			
25	25	22,4	60	160	2	CEB90 TE25.025 Z02 160	HA	5149524	○	TE.. 25	AP12-60200 5118707 M _A = 8Nm	IP25 5118727
25	25	22,4	90	210	2	CEB90 TE25.025 Z02 210	HA	5149525	●			

Bezeichnung Wendeschneidplatte BALLtec / TORROtec

Description Insert BALLtec / TORROtec

FHF = Finishing **H**ard **F**ine

MHF = Medium **H**ard **F**ine

SHF = Semifinishing **H**ard **F**ine

FHN2 = Finishing **H**ard **N**eutral 2

MHN = Medium **H**ard **N**eutral

MHN2 = Medium **H**ard **N**eutral 2

SHN = Semifinishing **H**ard **N**eutral

SHN2 = Semifinishing **H**ard **N**eutral 2



Bestellbeispiel Order example: 1 Stück piece 5149510 oder or CEB90 TE08.008 Z02 80

● Verfügbar ab Lager Available from stock

○ Lieferzeit auf Anfrage Delivery time on request

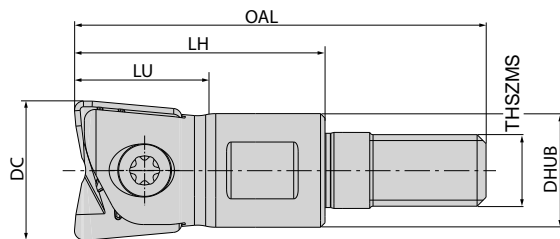
Einschraubfräser / TE..
Screw on type / TE..



Abmessungen [mm] Dimension [mm]							Artikelbezeichnung Item code	Bestell-Nr. Ordering No.	Verfügbarkeit Availability		Ersatzteile Spare parts	
DC	DHUB	LH	LU	OAL	THSZMS	ZEFF						
8	7,7	23	23	36	M4,5	2	BS90 TE08.008 Z02 077 M4.5	5149530	●	TE.. 08	AP12-25063 5118702 M _A = 1,4Nm	IP7 5118123
8	9,7	23	13	36,5	M6	2	BS90 TE08.008 Z02 M6	5136370	○		AP12-30077 5118703 M _A = 2,5Nm	IP8 5088519
10	9,7	23	23	36,5	M6	2	BS90 TE10.010 Z02 M6	5136372	●	TE.. 10	AP12-35095 5118704 M _A = 3,5Nm	IP10 5118726
12	9,7	23	23	36,5	M6	2	BS90 TE12.012 Z02 M6	5136376	●	TE.. 12	AP12-40133 5118705 M _A = 5Nm	IP15 5088520
12	12,7	28	17	44	M8	2	BS90 TE12.012 Z02 M8	5136377	●			
16	12,7	28	28	44	M8	2	BS90 TE16.016 Z02 M8	5136379	●	TE.. 16	AP12-50162 5118706 M _A = 7Nm	IP20 5088521
16	15,4	28	28	47	M10	2	BS90 TE16.016 Z02 M10	5136513	●			
20	17,7	28	28	46	M10	2	BS90 TE20.020 Z02 M10	5136382	●	TE.. 20	AP12-60200 5118707 M _A = 8Nm	IP25 5118727
25	20,7	35	35	55	M12	2	BS90 TE25.025 Z02 M12	5136384	●	TE.. 25		

* max. Einsatzlänge in mm
max. application length in mm

Die passenden Hartmetallverlängerungen finden Sie auf Seite 294
You will find the matching carbide extensions on page 294



N = Anzahl der Schneidkanten N = Number of cutting edges	Artikelbezeichnung Item code	Schneidstoffsorte Cutting materials	Bestell-Nr. Ordering No.	Verfügbarkeit Availability	Abmessungen [mm] Dimensions [mm]						
					W1	LE	L	S	D1	RE	
	TE 0805-SHF	BCH10M	5187724	○	7	1,5	8	2,4	2,5	0,5	
	TE 0810-SHF	BCH10M	5136374	●	7	2	8	2,4	2,5	1	
	TE 1005-SHF	BCH10M	5143786	●	8,5	2	10	2,6	3	0,5	
	TE 1010-SHF	BCH10M	5136385	●	8,5	2	10	2,6	3	1	
	TE 1015-SHF	BCH10M	5143787	○	8,5	2	10	2,6	3	1,5	
	TE 1205-SHF	BCH10M	5143790	●	10	2	12	3	3,5	0,5	
	TE 1210-SHF	BCH10M	5136390	●	10	2	12	3	3,5	1	
	TE 1215-SHF	BCH10M	5143791	○	10	2	12	3	3,5	1,5	
	TE 1220-SHF	BCH10M	5136391	○	10	3	12	3	3,5	2	
	TE 1605-SHF	BCH10M	5143793	○	12	2	16	4	4	0,5	
	TE 1610-SHF	BCH10M	5136396	●	12	2	16	4	4	1	
	TE 1615-SHF	BCH10M	5143794	○	12	2	16	4	4	1,5	
	TE 1630-SHF	BCH10M	5136397	●	12	4	15	4	4	3	
	TE 2010-SHF	BCH10M	5136402	●	15	2	20	5	5	1	
	TE 2040-SHF	BCH10M	5136403	○	15	5	20	5	5	4	
	TE 2510-SHF	BCH10M	5136413	●	18,5	2	25	6	6	1	
	TE 2550-SHF	BCH10M	5136414	○	18,5	6	25	6	6	5	
	<p>CEDC = 2</p>	TE 0805-MHN	BCH10M	5152007	○	7	1,5	8	2,4	2,5	0,5
		TE 0806-MHN	BCH10M	5136378	○	7	1,6	8	2,4	2,5	0,6
		TE 0810-MHN	BCH10M	5136381	○	7	2	8	2,4	2,5	1
TE 0820-MHN		BCH10M	5152010	○	7	3	8	2,4	2,5	2,0	
TE 1005-MHN		BCH10M	5136386	○	8,5	1,5	10	2,6	3	0,5	
TE 1008-MHN		BCH10M	5136387	●	8,5	1,8	10	2,6	3	0,8	
TE 1010-MHN		BCH10M	5136388	●	8,5	2	10	2,6	3	1	
TE 1015-MHN		BCH10M	5143789	○	8,5	2	10	2,6	3	1,5	
TE 1205-MHN		BCH10M	5136392	●	10	1,5	12	3	3,5	0,5	
TE 1210-MHN		BCH10M	5136393	●	10	2	12	3	3,5	1	
TE 1215-MHN		BCH10M	5143792	○	10	2	12	3	3,5	1,5	
TE 1220-MHN		BCH10M	5136394	○	10	3	12	3	3,5	2	
TE 1605-MHN		BCH10M	5143795	○	12	2	16	4	4	0,5	
TE 1610-MHN		BCH10M	5136399	●	12	2	16	4	4	1	
TE 1615-MHN		BCH10M	5143796	○	12	2	16	4	4	1,5	
TE 1630-MHN		BCH10M	5136400	●	12	4	16	4	4	3	
TE 2010-MHN		BCH10M	5136404	●	15	2	20	5	5	1	
TE 2040-MHN		BCH10M	5136409	●	15	5	20	5	5	4	
TE 2510-MHN		BCH10M	5136415	○	18,5	2	25	6	6	1	
TE 2550-MHN		BCH10M	5136417	○	18,5	6	25	6	6	5	

Bezeichnung Wendeschneidplatte TORROtec
Description insert TORROtec

SHF = Semifinishing **H**ard **F**ine
MHN = **M**edium **H**ard **N**eutral

Bestellbeispiel Order example: 10 Stück pieces 5136374 oder or TE 0810-SHF BCH10M

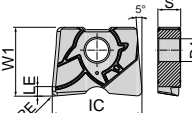
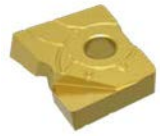
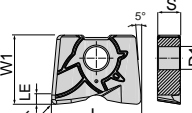
● Verfügbar ab Lager Available from stock
○ Lieferzeit auf Anfrage Delivery time on request

N = Anzahl der Schneidkanten N = Number of cutting edges	Artikelbezeichnung Item code	Schneidstoffsorte Cutting materials	Bestell-Nr. Ordering No.	Verfügbarkeit Availability	Abmessungen [INCH] Dimensions [INCH]					
					W1	LE	L	S	D1	RE
 	TE 03120015-SHF	BCH10M	5151517	○	0.273	0.054	0.312	0.094	0.098	0.015
	TE 03120031-SHF	BCH10M	5151519	○	0.273	0.070	0.312	0.094	0.098	0.031
	TE 03120062-SHF	BCH10M	5151520	○	0.273	0.100	0.312	0.094	0.098	0.062
	TE 03750015-SHF	BCH10M	5151524	○	0.324	0.054	0.375	0.102	0.119	0.015
	TE 03750031-SHF	BCH10M	5151525	●	0.324	0.070	0.375	0.102	0.119	0.031
	TE 03750062-SHF	BCH10M	5151526	●	0.324	0.100	0.375	0.102	0.119	0.062
	TE 05000015-SHF	BCH10M	5151532	○	0.406	0.054	0.500	0.119	0.138	0.015
	TE 05000031-SHF	BCH10M	5151533	●	0.406	0.070	0.500	0.119	0.138	0.031
	TE 05000062-SHF	BCH10M	5151534	●	0.406	0.100	0.500	0.119	0.138	0.062
	TE 06250031-SHF	BCH10M	5151541	○	0.468	0.070	0.625	0.137	0.157	0.031
	TE 06250062-SHF	BCH10M	5151542	○	0.468	0.100	0.625	0.137	0.157	0.062
	TE 06250125-SHF	BCH10M	5151543	○	0.468	0.165	0.625	0.137	0.157	0.125
	TE 07500031-SHF	BCH10M	5147182	●	0.570	0.070	0.750	0.197	0.197	0.031
	TE 07500062-SHF	BCH10M	5151548	●	0.570	0.100	0.750	0.197	0.197	0.062
	TE 07500125-SHF	BCH10M	5151549	○	0.570	0.165	0.750	0.197	0.197	0.125
	TE 10000031-SHF	BCH10M	5151553	●	0.732	0.070	1.000	0.236	0.236	0.031
	TE 10000062-SHF	BCH10M	5151554	●	0.732	0.100	1.000	0.236	0.236	0.062
	TE 10000125-SHF	BCH10M	5151556	○	0.732	0.165	1.000	0.236	0.236	0.125
	TE 10000250-SHF	BCH10M	5151557	○	0.732	0.290	1.000	0.236	0.236	0.250
	CEDC = 2									
 	TE 03120015-MHN	BCH10M	5151521	○	0.273	0.054	0.312	0.094	0.098	0.015
	TE 03120031-MHN	BCH10M	5151522	○	0.273	0.070	0.312	0.094	0.098	0.031
	TE 03120062-MHN	BCH10M	5151523	○	0.273	0.100	0.312	0.094	0.098	0.062
	TE 03750015-MHN	BCH10M	5151527	○	0.324	0.054	0.375	0.102	0.118	0.015
	TE 03750031-MHN	BCH10M	5151528	○	0.324	0.070	0.375	0.102	0.118	0.031
	TE 03750062-MHN	BCH10M	5151529	●	0.324	0.100	0.375	0.102	0.118	0.063
	TE 05000015-MHN	BCH10M	5151535	○	0.406	0.054	0,500	0.119	0.138	0.015
	TE 05000031-MHN	BCH10M	5151537	●	0.406	0.070	0,500	0.119	0.138	0.031
	TE 05000062-MHN	BCH10M	5151538	●	0.406	0.100	0,500	0.119	0.138	0.062
	TE 06250031-MHN	BCH10M	5151544	○	0.470	0.070	0.625	0.157	0.157	0.031
	TE 06250062-MHN	BCH10M	5151545	○	0.470	0.100	0.625	0.157	0.157	0.062
	TE 06250125-MHN	BCH10M	5151546	○	0.470	0.165	0.625	0.157	0.157	0.125
	TE 07500031-MHN	BCH10M	5147184	●	0.570	0.070	0.750	0.197	0.197	0.031
	TE 07500062-MHN	BCH10M	5151551	●	0.570	0.100	0.750	0.197	0.197	0.062
	TE 07500125-MHN	BCH10M	5151552	○	0.570	0.165	0.750	0.197	0.197	0.125
	TE 10000031-MHN	BCH10M	5151558	●	0.736	0.070	1.000	0.236	0.236	0.031
	TE 10000062-MHN	BCH10M	5151559	●	0.736	0.100	1.000	0.236	0.236	0.062
	TE 10000125-MHN	BCH10M	5151560	○	0.736	0.165	1.000	0.236	0.236	0.125
	TE 10000250-MHN	BCH10M	5151561	○	0.736	0.290	1.000	0.236	0.236	0.250
	CEDC = 2									

● Verfügbar ab Lager Available from stock

○ Lieferzeit auf Anfrage Delivery time on request

Bestellbeispiel Order example: 10 Stück pieces 5151517 oder or TE 03120015-SHF BCH10M

Einschraubfräser 45° Screw on type 45°	
Ausführung Execution	
Durchmesserbereich metrisch Diameter range metric	Ø 16 - 42 mm
Plattengröße Insert size	CD.. 06

Besondere Merkmale:

- Universal einsetzbares Schlichtwerkzeug für alle gängigen Werkstoffe und Anwendungen
- Besonders verschleißfeste und exakt gefertigte Wendeschneidplatten
- Axiale & radiale Wiper Geometrie FW für höhere Produktivität (mehr a_p & f_z möglich)
- Vibrationsfreies Schlichten auch in großen Tiefen
- Schneidkreisdurchmesser D_c in Kombination FW, Geometrie um 0,15 mm kleiner

Special features:

- Universal applicable finishing tool for all current materials and applications
- Especially wear resistant and exact produced inserts
- Axial & radial wiper geometry FW for higher productivity (bigger a_p & f_z possible)
- Vibration free finishing, also with big depths
- Cutting circle diameter D_c in combination FW, geometry by 0,15 mm smaller

WSP Geometrie Insert geometry	CD.. 06	
	Schnitttiefe* Cutting depth* [mm] APMX max	Vorschub* Feed* [mm] f_z
FH	0,10 0,25 1,00	0,08 0,22 0,33
FW	0,12 0,25 1,80	0,10 0,25 0,40

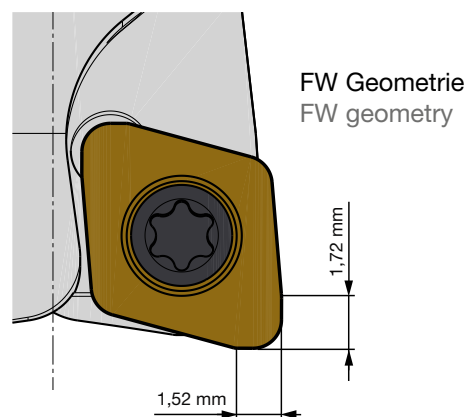



Schnittwertempfehlungen siehe Seite 174
Cutting data recommendations page 174

* Angegebene Schnittdaten sind als Richtwert zu sehen, welche durch Versuche für jeden Anwendungsfall separat optimiert werden können.
* Recommended cutting data has to be seen as a reference which can be optimised for each application through trials separately.

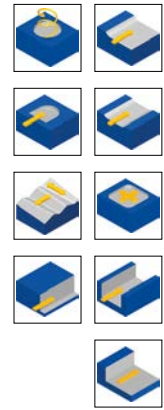
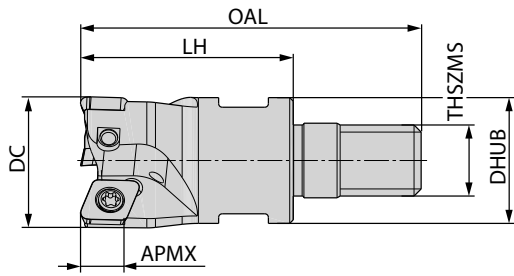
Einschraubfräser 95°P / CD.. 06
Screw on type 95°P / CD.. 06





Abmessungen [mm] Dimension in [mm]							Artikelbezeichnung Item code	Bestell-Nr. Ordering No.	Verfügbarkeit Availability		Ersatzteile Spare parts	
*DC	DHUB	LH	OAL	APMX	ZEFF	THSZMS						
16	12,7	23	39	6	2	M8	BS95 CD06.016 Z02 M8	5117381	●	CDGX 06	Spannschraube Fixation screw AP17-25056 5150331 M _A = 1,2Nm	Torx-Schlüssel Torque wrench IP7 5118123
16	15,5	23	42	6	2	M10	BS95 CD06.016 Z02 M10	5117405	●			
20	17,7	30	49	6	3	M10	BS95 CD06.020 Z03 M10	5117383	●			
25	20,7	35	55	6	3	M12	BS95 CD06.025 Z03 M12	5117385	●			
25	20,7	35	55	6	4	M12	BS95 CD06.025 Z04 M12	5117386	●			
35	28,7	43	65	6	5	M16	BS95 CD06.035 Z05 M16	5131668	●			
42	28,7	43	65	6	6	M16	BS95 CD06.042 Z06 M16	5131669	●			

*in Kombination mit FW-Geometrie verringert sich der D_C (Schneidkreisdurchmesser) um 0,15mm
*in combination with FW geometry the D_C (cutting circle diameter) decreases by 0.15mm

Die passenden Hartmetallverlängerungen finden Sie auf Seite 294
You will find the matching carbide extensions on page 294

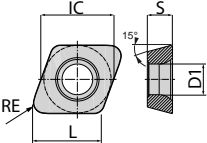
Wendeschneidplatten / Inserts

N = Anzahl der Schneidkanten N = Number of cutting edges	Artikelbezeichnung Item code	Schneidstoffsorte Cutting materials	Bestell-Nr. Ordering No.	Verfügbarkeit Availability	Abmessungen [mm] Dimensions [mm]				
					L	IC	S	D1	RE
  CEDC = 2	CDGX 060210 SR-FH	BCH10M	5117603	●	5,8	6,5	2,38	2,9	1
	CDGX 060210 SR-FH	BCH23M	5117604	●	5,8	6,5	2,38	2,9	1
	CDGX 060210 SR-FH	BCH30M	5117605	●	5,8	6,5	2,38	2,9	1
	CDGX 060210 SR-FW	BCH10M	5117608	●	1,72	6,5	2,38	2,9	1

Bestellbeispiel Order example: 1 Stück piece 5117381 oder or BS95 CD06.016 Z02 M8

● Verfügbar ab Lager Available from stock
○ Lieferzeit auf Anfrage Delivery time on request

	Aufsteckfräser Face milling cutter	Einschraubfräser Screw on type
Ausführung Execution		
Durchmesserbereich metrisch Diameter range metric	Ø 42 - 80 mm	Ø 32 - 42 mm
Plattengröße Insert size	VC.. 22	VC.. 22

Besondere Merkmale:

- Tauchfräswerkzeug speziell abgestimmt auf die Bearbeitung von NE-Metallen
- Hohe Eintauchwinkel durch spezielles Grundkörper Design realisierbar

Special features:

- Plunge milling tool specially adapted to the machining of non-ferrous metals
- High ramping in angels possible trough special design of cutter bodies

Eintauchwinkel Ramping angle



WSP Geometrie Insert geometry	VCGT 22	
	Schnitttiefe* Cutting depth* [mm] APMX max	Vorschub* Feed* [mm] fz
MN	1,0 7,5 15,0	0,06 0,18 0,35

Durchmesser Fräser Diameter Milling cutter	Eintauchwinkel max. α Ramping angle α max. VCGT 22
Ø 32	35°
Ø 42	23°
Ø 52	17°
Ø 66	12,5°
Ø 80	10°

Abbildung der Wendschneiplatten können vom Lagerartikel in Ausführung und Farbe abweichen!
Colours and execution of the original indexable inserts, may deviate from the illustration!

Schnittwertempfehlungen siehe Seite 174
Cutting data recommendations page 174

* Angegebene Schnittdaten sind als Richtwert zu sehen, welche durch Versuche für jeden Anwendungsfall separat optimiert werden können.
* Recommended cutting data has to be seen as a reference which can be optimised for each application through trials separately.

Aufsteckfräser 90° / VC.. 22
Face milling cutter 90° / VC.. 22

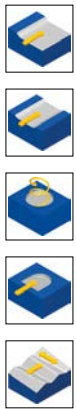
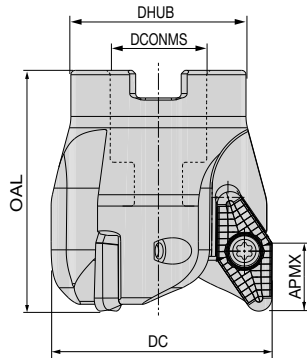

Abmessungen [mm] Dimensions [mm]						Artikelbezeichnung Item code	Bestell-Nr. Ordering No.	Verfügbarkeit Availability	Ersatzteile Spare parts			
DC	DCONMS	DHUB	OAL	APMX	ZEFF				 Spannschraube Fixation screw AP13-45110 5172494 M _A = 5Nm	 Torx-Schlüssel Torque wrench IP20 5088521		
42	16	32	55	15	3	BF90 VC22.042 Z03	5154254	●				
52	22	40	55	15	3	BF90 VC22.052 Z03	5154258	●				
66	27	50	56	15	4	BF90 VC22.066 Z04	5154261	●				
80	27	60	56	15	4	BF90 VC22.080 Z04	5154294	●				

Bestellbeispiel Order example: 1 Stück piece 5154254 oder or BF90 VC22 042 Z03

Abbildung der Wendschneiplatten können vom Lagerartikel in Ausführung und Farbe abweichen!
 Colours and execution of the original indexable inserts, may deviate from the illustration!

Einschraubfräser 90° / VC.. 22 Screw on type 90° / VC.. 22

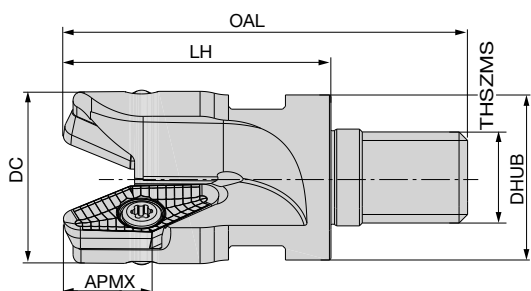

Abmessungen [mm]		Dimensions [mm]					Artikelbezeichnung Item code	Bestell-Nr. Ordering No.	Verfügbarkeit Availability	Ersatzteile Spare parts	
DC	DHUB	LH	OAL	APMX	THSZMS	ZEFF [☆]					
32	29	47	71	15	M16	2	BS90 VC22.032 Z02 M16	5154298	●		
42	29	47	71	15	M16	3	BS90 VC22.042 Z03 M16	5154299	●		

Bestellbeispiel Order example: 1 Stück piece 5154298 oder or BS90 VC22.032 Z02 M16

N = Anzahl der Schneidkanten N = Number of cutting edges	Artikelbezeichnung Item code	Schneidstoffsorte Cutting materials	Bestell-Nr. Ordering No.	Verfügbarkeit Availability	Abmessungen [mm] Dimensions [mm]					
					L	IC	S	D1	RE	
 CEDC = 2	VCGT 220530-MN	BWN10M	5173008	●	22,10	12,70	5,56	5,5	3,0	
	VCGT 220530-MN	BCN10M	5173009	●	22,10	12,70	5,56	5,5	3,0	

Bestellbeispiel Order example: 10 Stück pieces 5173008 oder or VCGT 220530-MN BWN10M
Die passenden Hartmetallverlängerungen finden Sie auf Seite 294
You will find the matching carbide extensions on page 294

- Verfügbar ab Lager Available from stock
- ⊙ kurzfristig lieferbar available at short notice

	Aufsteckfräser 45° Face milling cutter 45°	Schaftfräser 45° End milling cutter 45°	Einschraubfräser 45° Screw on type 45°
Ausführung Execution			
Durchmesserbereich metrisch Diameter range metric	Ø 40 - 160 mm	Ø 15 - 20 mm	Ø 10 - 42 mm
Durchmesserbereich inch Diameter range inch	Ø 1 1/2" - 5"	-	-
Plattengröße Insert size	RD.. 10, RD.. 12, RD.. 16	RD.. 07, RD.. 10	RD.. 05, RD.. 07, RD.. 10, RD.. 12, RD.. 16

Besondere Merkmale:

- Universell einsetzbares Werkzeugsystem für den allgemeinen Maschinenbau und den Formenbau
- Neutrale Einbaulage der Wendschneidplatten in den Trägerwerkzeugen für eine optimale Konturgenauigkeit
- Spezieller Schutz im Plattensitz der Wendeplattenkante vor Spanschlag
- Hohe Sortimentstiefe bei Wendeplatten und Trägerwerkzeugen
- Sanftes Schnittverhalten, durch spezielle Wendschneidplatten Geometrie, trotz neutraler Einbaulage

Special features:

- Universal applicable tool system for general machining and mould construction
- Neutral mounting position of the insert in the tool for an optimal contour precision
- Special protection against chip impact on the insert seat of the insert's cutting edge
- Big assortment depth of inserts and tools
- Smooth cutting behaviour due to special geometry of inserts, despite neutral mounting position

WSP Geometrie Insert geometry	RD.. 0501		RD.. 0702		RD.. 1003	
	Schnitttiefe* Cutting depth* [mm] APMX max	Vorschub* Feed* [mm] f _z	Schnitttiefe* Cutting depth* [mm] APMX max	Vorschub* Feed* [mm] f _z	Schnitttiefe* Cutting depth* [mm] APMX max	Vorschub* Feed* [mm] f _z
MP	0,25 0,70 1,20	0,14 0,26 0,50	0,25 1,00 1,70	0,14 0,27 0,60	0,28 1,50 2,50	0,15 0,28 0,64
MM	0,25 0,70 1,20	0,13 0,23 0,45	0,25 1,00 1,70	0,13 0,24 0,52	0,26 1,50 2,50	0,14 0,25 0,55
MK	0,25 0,70 1,20	0,15 0,27 0,53	0,25 1,00 1,70	0,15 0,28 0,63	0,28 1,50 2,50	0,16 0,30 0,67
FH	0,10 0,18 0,45	0,10 0,20 0,36	0,10 0,20 0,65	0,11 0,22 0,42	0,12 0,22 0,90	0,12 0,28 0,45
MH	0,10 0,18 0,45	0,10 0,20 0,36	0,10 0,20 0,65	0,11 0,22 0,42	0,12 0,22 0,90	0,12 0,28 0,45
RH	0,12 0,24 0,60	0,10 0,22 0,40	0,12 0,25 0,85	0,11 0,25 0,46	0,14 0,28 1,20	0,12 0,30 0,50

WSP Geometrie Insert geometry	RD.. 12T3		RD.. 1604	
	Schnitttiefe* Cutting depth* [mm] APMX max	Vorschub* Feed* [mm] f _z	Schnitttiefe* Cutting depth* [mm] APMX max	Vorschub* Feed* [mm] f _z
MP	0,30 1,80 3,00	0,16 0,29 0,70	0,30 2,40 4,00	0,18 0,30 0,75
MM	0,27 1,80 3,00	0,15 0,25 0,60	0,27 2,40 4,00	0,16 0,25 0,64
MK	0,30 1,80 3,00	0,18 0,32 0,75	0,30 2,40 4,00	0,18 0,33 0,80
MS	0,10 1,25 2,00	0,10 0,25 0,54	0,10 1,60 2,65	0,10 0,28 0,60
FH	0,12 0,25 1,10	0,13 0,28 0,50	0,12 0,28 1,60	0,14 0,28 0,50
MH	0,12 0,25 1,10	0,13 0,28 0,50	0,12 0,28 1,60	0,14 0,28 0,50
RH	0,14 0,30 1,50	0,13 0,30 0,56	0,15 0,35 2,00	0,14 0,30 0,56

Schnittwertempfehlungen siehe Seite 174

Cutting data recommendations page 174

* Angegebene Schnittdaten sind als Richtwert zu sehen, welche durch Versuche für jeden Anwendungsfall separat optimiert werden können.

* Recommended cutting data has to be seen as a reference which can be optimised for each application through trials separately.



ISO 00P

Systemgröße 05 System size 05

www.boehlerit.com

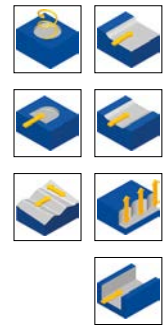
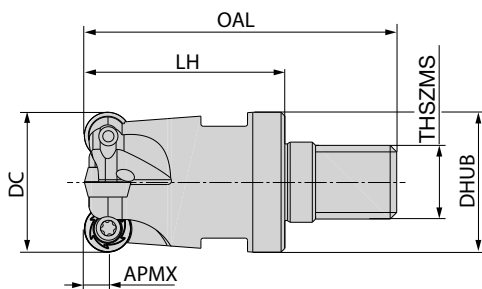
Einschraubfräser ISO 00P konisch Form A / RD.. 05 Screw on type ISO 00P conical form A / RD.. 05



Abmessungen [mm] Dimensions [mm]							Artikelbezeichnung Item code	Bestell-Nr. Ordering No.	Verfügbarkeit Availability		Ersatzteile Spare parts	
DC	DHUB	LH	OAL	THSZMS	APMX	ZEFF \odot						
10	13	23	40	M8	2,5	2	BSA00 RD05.010 Z02 M8	5116889	●	RD.. 05	AP13-18037 5118116 $M_A = 0,5Nm$	IP6 5126412
12	13	23	40	M8	2,5	3	BSA00 RD05.012 Z03 M8	5116890	●			

Einschraubfräser ISO 00P zylindrisch Form B / RD.. 05 Screw on type ISO 00P cylindrical form B / RD.. 05

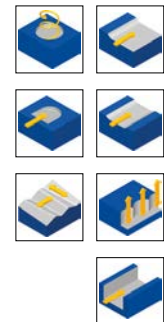
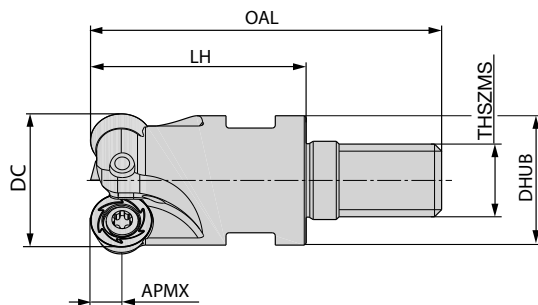

Abmessungen [mm] Dimensions [mm]							Artikelbezeichnung Item code	Bestell-Nr. Ordering No.	Verfügbarkeit Availability		Ersatzteile Spare parts	
DC	DHUB	LH	OAL	THSZMS	APMX	ZEFF \odot						
15	13	23	40	M8	2,5	4	BSB00 RD05.015 Z04 M8	5116891	●	RD.. 05	AP13-18037 5118116 $M_A = 0,5Nm$	IP6 5126412
16	13	23	40	M8	2,5	4	BSB00 RD05.016 Z04 M8	5116894	●			
20	18	30	49	M10	2,5	5	BSB00 RD05.020 Z05 M10	5116896	●			
25	21	35	57	M12	2,5	6	BSB00 RD05.025 Z06 M12	5116897	●			

Bestellbeispiel Order example: 1 Stück piece 5116889 oder or BSA00 RD05.010 Z02 M8

Die passenden Hartmetallverlängerungen finden Sie auf Seite 294
You will find the matching carbide extensions on page 294

N = Anzahl der Schneidkanten N = Number of cutting edges	Artikelbezeichnung Item code	Schneidstoffsorte Cutting materials	Bestell-Nr. Ordering No.	Verfügbarkeit Availability	Abmessungen [mm] Dimensions [mm]		
					IC	S	D ₁
	RDKW 0501 MOS-MP	BCP20M	5117486	●	5	1,5	2,2
	RDKW 0501 MOS-MP	BCP25M	5117495	●	5	1,5	2,2
	RDKW 0501 MOS-MM	BCM35M	5117482	●	5	1,5	2,2
	RDKW 0501 MOS-MM	BCM40M	5117483	●	5	1,5	2,2
	RDKW 0501 MOS-MK	BCK15M	5117479	●	5	1,5	2,2
	RDKW 0501 MOS-MK	BCK20M	5117481	●	5	1,5	2,2
	RDKW 0501 MOS-FH	BCH03M	5117408	●	5	1,5	2,2
	RDKW 0501 MOS-MH	BCH05M	5117414	●	5	1,5	2,2
	RDKW 0501 MOS-MH	BCH10M	5117477	●	5	1,5	2,2
	RDKW 0501 MOS-RH	BCH30M	5117537	●	5	1,5	2,2

Schafffräser ISO 00P konisch Form A / RD.. 07
End milling cutter ISO 00P conical form A / RD.. 07

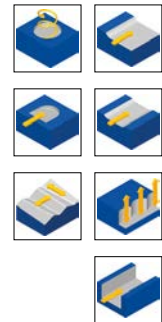
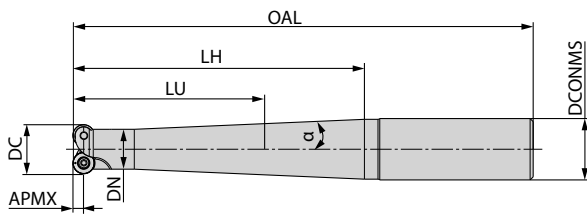

Abmessungen [mm] Dimensions [mm]									Artikelbezeichnung Item code	Schaft Shank	Bestell-Nr. Ordering-No	Verfügbarkeit Availability		Ersatzteile Spare parts	
DC	DCONMS	DN	LH	LU	α	OAL	APMX	ZEFF							
15	16	13	55	48	2,0°	108	3,5	2	BEA00 RD07.015 Z02 108	HA	5116865	●		AP13-25055 5118117 MA = 2Nm IP7 5118123	
15	20	13	75	36	3,4°	130	3,5	2	BEA00 RD07.015 Z02 130	HA	5116866	●			
15	20	13	95	43	2,5°	150	3,5	2	BEA00 RD07.015 Z02 150	HA	5116867	○			
15	25	13	115	36	3,5°	176	3,5	2	BEA00 RD07.015 Z02 176	HA	5116868	○			
16	16	13	55	60	2,0°	108	3,5	2	BEA00 RD07.016 Z02 108	HA	5116870	○			
16	20	13	75	45	3,4°	130	3,5	2	BEA00 RD07.016 Z02 130	HA	5116871	○			
16	20	13	95	54	2,5°	150	3,5	2	BEA00 RD07.016 Z02 150	HA	5116872	●			
16	25	13	115	44	3,5°	176	3,5	2	BEA00 RD07.016 Z02 176	HA	5116873	○			

- Verfügbar ab Lager Available from stock
- kurzfristig lieferbar available at short notice
- Lieferzeit auf Anfrage Delivery time on request

Bestellbeispiel Order example: 10 Stück pieces 5117486 oder or RDKW 0501 MOS-MP BCP20M



ISO 00P

Systemgröße 07 System size 07

www.boehlerit.com

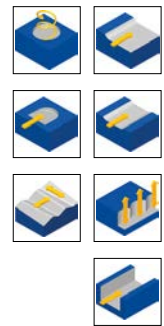
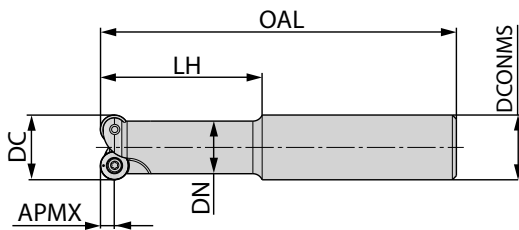
Schaftfräser ISO 00P zylindrisch Form B / RD.. 07 End milling cutter ISO 00P cylindrical form B / RD.. 07



Abmessungen [mm] Dimension [mm]							Artikelbezeichnung Item code	Schaft Shank	Bestell-Nr. Ordering-No	Verfügbarkeit Availability		Ersatzteile Spare parts	
DC	DCONMS	DN	LH	OAL	APMX	ZEFF \odot							
15	16	13	40	88	3,5	2	BEB00 RD07.015 Z02 088	HA	5116864	●	RD.. 07	AP13-25055 5118117 MA = 2Nm	IP7 5118123
16	16	13	40	88	3,5	2	BEB00 RD07.016 Z02 088	HA	5116869	●			

Einschraubfräser ISO 00P konisch Form A / RD.. 07 Screw on type ISO 00P conical form A / RD.. 07

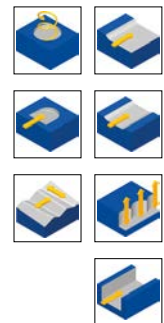
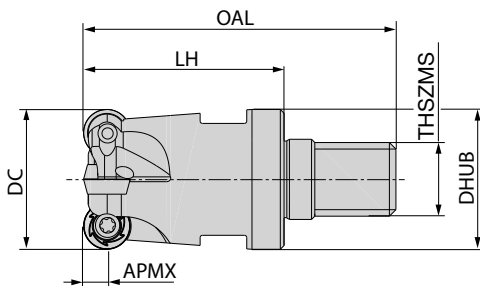

Abmessungen [mm] Dimension [mm]							Artikelbezeichnung Item code	Bestell-Nr. Ordering No.	Verfügbarkeit Availability		Ersatzteile Spare parts	
DC	DHUB	LH	OAL	THSZMS	APMX	ZEFF \odot						
30	29	43	67	M16	3,5	5	BSA00 RD07.030 Z05 M16	5116909	●	RD.. 07	AP13-25055 5118117 MA = 2Nm	IP7 5118123

Bestellbeispiel Order example: 1 Stück piece 5116864 oder or BEB00 RD07.015 Z02 088

Die passenden Hartmetallverlängerungen finden Sie auf Seite 294

You will find the matching carbide extensions on page 294

Einschraubfräser ISO 00P zylindrisch Form B / RD.. 07
Screw on type ISO 00P cylindrical form B / RD.. 07

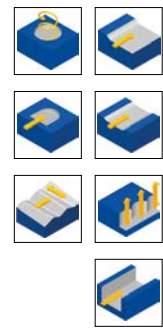
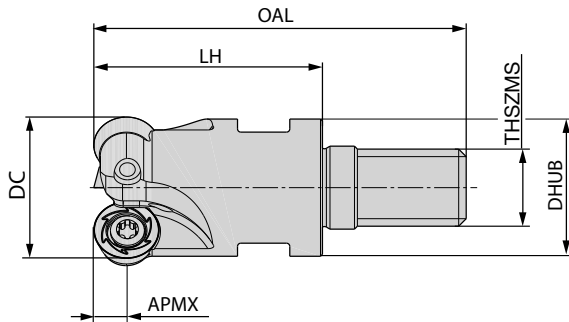

Abmessungen [mm] Dimension [mm]							Artikelbezeichnung Item code	Bestell-Nr. Ordering No.	Verfügbarkeit Availability		Ersatzteile Spare parts	
DC	DHUB	LH	OAL	THSZMS	APMX	ZEFF [⊙]						
15	13	23	40	M8	3,5	2	BSB00 RD07.015 Z02 M8	5116899	●	RD.. 07	Spannschraube Fixation screw AP13-25055 5118117 M _A = 2Nm	Torx-Schlüssel Torque wrench IP7 5118123
15	13	23	40	M8	3,5	3	BSB00 RD07.015 Z03 M8	5116901	●			
16	13	23	40	M8	3,5	2	BSB00 RD07.016 Z02 M8	5116902	●			
16	13	23	40	M8	3,5	3	BSB00 RD07.016 Z03 M8	5116904	●			
20	18	30	49	M10	3,5	4	BSB00 RD07.020 Z04 M10	5116905	●			
25	21	35	57	M12	3,5	5	BSB00 RD07.025 Z05 M12	5116906	●			
32	29	43	67	M16	3,5	6	BSB00 RD07.032 Z06 M16	5116910	●			
35	29	43	67	M16	3,5	6	BSB00 RD07.035 Z06 M16	5116911	●			

Bestellbeispiel Order example: 1 Stück piece 5116899 oder or BSB00 RD07.015 Z02 M8

N = Anzahl der Schneidkanten N = Number of cutting edges	Artikelbezeichnung Item code	Schneidstoffsorte Cutting materials	Bestell-Nr. Ordering No.	Verfügbarkeit Availability	Abmessungen [mm] Dimensions [mm]		
					IC	S	D ₁
 	RDKW 0702 MOS-MP	BCP20M	5117535	○	7	2,38	2,7
	RDKW 0702 MOS-MP	BCP25M	5117529	●	7	2,38	2,7
	RDKW 0702 MOS-MP	BCP30M	5117509	●	7	2,38	2,7
	RDKW 0702 MOS-MP	BCP35M	5117510	●	7	2,38	2,7
	RDKW 0702 MOS-MM	BCM35M	5117538	●	7	2,38	2,7
	RDKW 0702 MOS-MM	BCM40M	5117539	●	7	2,38	2,7
	RDKW 0702 MOS-MK	BCK15M	5117504	●	7	2,38	2,7
	RDKW 0702 MOS-MK	BCK20M	5117507	●	7	2,38	2,7
	RDHW 0702 MOS-FH	BCH03M	5117498	●	7	2,38	2,7
	RDHW 0702 MOS-MH	BCH05M	5147192	●	7	2,38	2,7
	RDHW 0702 MOS-MH	BCH10M	5147195	●	7	2,38	2,7
	RDHW 0702 MOS-RH	BCH30M	5147198	●	7	2,38	2,7
	RDKW 0702 MOS-MH	BCH05M	5117501	●	7	2,38	2,7
	RDKW 0702 MOS-MH	BCH10M	5117503	●	7	2,38	2,7
	RDKW 0702 MOS-RH	BCH30M	5117622	●	7	2,38	2,7

Bestellbeispiel Order example: 10 Stück pieces 5117535 oder or RDKW 0702 MOS-MP BCP20M
Die passenden Hartmetallverlängerungen finden Sie auf Seite 294
You will find the matching carbide extensions on page 294

- Verfügbar ab Lager Available from stock
- kurzfristig lieferbar available at short notice
- Lieferzeit auf Anfrage Delivery time on request



ISO 00P

Systemgröße 10 System size 10

www.boehlerit.com

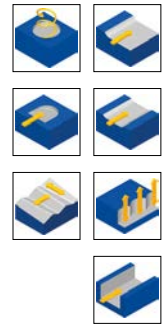
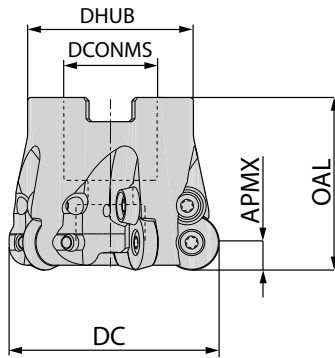
Aufsteckfräser ISO 00P / RD.. 10 Face milling cutter ISO 00P / RD.. 10



Abmessungen [INCH] Dimension [INCH]						Artikelbezeichnung Item code	Bestell-Nr. Ordering No.	Verfügbarkeit Availability		Ersatzteile Spare parts	
DC	DCONMS	DHUB	OAL	APMX	ZEFF \odot						
40	16	32	40	5	5	BF00 RD10.040 Z05	5116928	●	RD.. 10	AP13-35072 5118118 $M_A = 3,5Nm$	IP15 5088520
42	16	32	40	5	5	BF00 RD10.042 Z05	5116932	○			
52	22	40	50	5	5	BF00 RD10.052 Z05	5116934	●			
52	22	40	50	5	7	BF00 RD10.052 Z07	5116935	●			

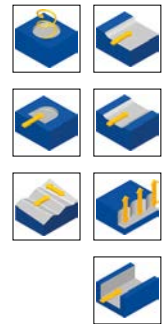
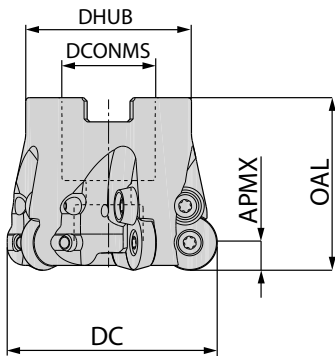

Abmessungen [INCH] Dimension [INCH]						Artikelbezeichnung Item code	Bestell-Nr. Ordering No.	Verfügbarkeit Availability		Ersatzteile Spare parts	
DC	DCONMS	DHUB	OAL	APMX	ZEFF \odot						
2.13	0.75	1.375	1.5	0.197	5	BFU00 RD10.1500 Z05	5133684	●	RD.. 10	AP13-35072 5118118 $M_A = 3,5Nm$	IP15 5088520
2.63	0.75	1.700	2.0	0.197	7	BFU00 RD10.2000 Z07	5133685	●			

Bestellbeispiel Order example: 1 Stück piece 5116928 oder or BF00 RD10.040 Z05

Schaftfräser ISO 00P konisch Form A / RD.. 10
End milling cutter ISO 00P conical form A / RD.. 10

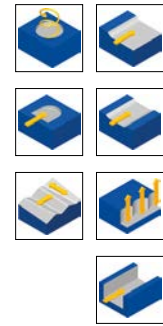
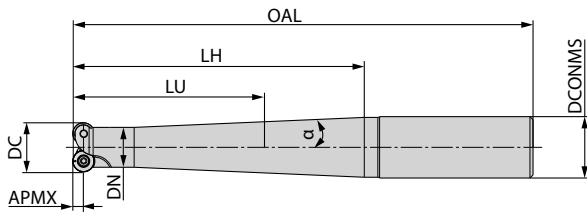

Abmessungen [mm] Dimension [mm]									Artikelbezeichnung Item code	Schaft Shank	Bestell-Nr. Ordering- No	Verfügbarkeit Availability	RD.. 10	Ersatzteile Spare parts	
DC	DCONMS	DN	LH	LU	α	OAL	APMX	ZEFF \odot							
20	20	18	35	40	2,9°	90	5	2	BEA00 RD10.020 Z02 090	HA	5116874	●	RD.. 10	AP13-35072 5118118 M _A = 3,5Nm IP15 5088520	
20	20	18	55	60	1,3°	110	5	2	BEA00 RD10.020 Z02 110	HA	5110337	○			
20	25	18	75	36	3,4°	136	5	2	BEA00 RD10.020 Z02 136	HA	5116875	○			
20	25	18	95	43	2,5°	156	5	2	BEA00 RD10.020 Z02 156	HA	5116876	○			
20	25	18	115	49	2,0°	176	5	2	BEA00 RD10.020 Z02 176	HA	5116877	○			

Einschraubfräser ISO 00P konisch Form A / RD.. 10
Screw on type ISO 00P conical form A / RD.. 10

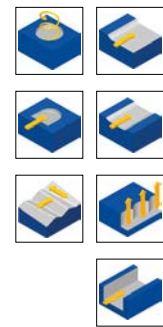
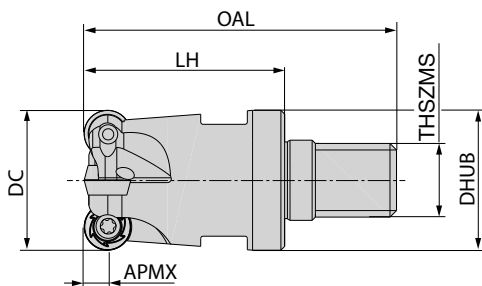

Abmessungen [mm] Dimension [mm]							Artikelbezeichnung Item code	Bestell-Nr. Ordering No.	Verfügbarkeit Availability	RD.. 10	Ersatzteile Spare parts	
DC	DHUB	LH	OAL	THSZMS	APMX	ZEFF \odot						
30	29	43	67	M16	5	4	BSA00 RD10.030 Z04 M16	5116913	○	RD.. 10	AP13-35072 5118118 M _A = 3,5Nm IP15 5088520	
32	29	43	67	M16	5	4	BSA00 RD10.032 Z04 M16	5116914	●			

Bestellbeispiel Order example: 1 Stück piece 5116874 oder or BEA00 RD10.020 Z02 090
Die passenden Hartmetallverlängerungen finden Sie auf Seite 294
You will find the matching carbide extensions on page 294

- Verfügbar ab Lager Available from stock
- kurzfristig lieferbar available at short notice
- Lieferzeit auf Anfrage Delivery time on request

ISO 00P

Systemgröße 10 System size 10

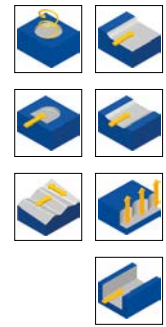
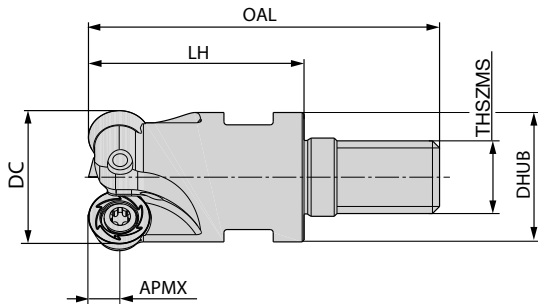

www.boehlerit.com

Einschraubfräser ISO 00P zylindrisch Form B / RD.. 10 Screw on type ISO 00P cylindrical form B / RD.. 10

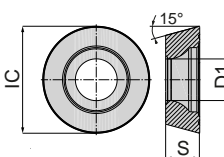

Abmessungen [mm] Dimension [mm]							Artikelbezeichnung Item code	Bestell-Nr. Ordering No.	Verfügbarkeit Availability		Ersatzteile Spare parts	
DC	DHUB	LH	OAL	THSZMS	APMX	ZEFF						
20	18	18	30	M10	5	2	BSB00 RD10.020 Z02 M10	5110310	●	RD.. 10	Spannschraube Fixation screw AP13-35072 5118118 M _A = 3,5Nm	Torx-Schlüssel Torque wrench IP15 5088520
25	21	21	35	M12	5	3	BSB00 RD10.025 Z03 M12	5116912	●			
35	29	29	43	M16	5	4	BSB00 RD10.035 Z04 M16	5111523	●			
35	29	29	43	M16	5	5	BSB00 RD10.035 Z05 M16	5111524	●			
40	29	29	43	M16	5	5	BSB00 RD10.040 Z05 M16	5116915	○			
42	29	29	43	M16	5	5	BSB00 RD10.042 Z05 M16	5116916	○			
42	29	29	43	M16	5	6	BSB00 RD10.042 Z06 M16	5116917	○			

Bestellbeispiel Order example: 1 Stück piece 5110310 oder or BSB00 RD10.020 Z02 M10

N = Anzahl der Schneidkanten N = Number of cutting edges	Artikelbezeichnung Item code	Schneidstoffsorte Cutting materials	Bestell-Nr. Ordering No.	Verfügbarkeit Availability	Abmessungen [mm] Dimensions [mm]		
					IC	S	D ₁
 	RDKW 1003 MOS-MP	BCP20M	5086933	●	10	3,18	3,9
	RDKW 1003 MOS-MP	BCP25M	5086932	●	10	3,18	3,9
	RDKW 1003 MOS-MP	BCP30M	5086935	●	10	3,18	3,9
	RDKW 1003 MOS-MP	BCP35M	5086934	●	10	3,18	3,9
	RDKW 1003 MOS-MM	BCM35M	5117626	●	10	3,18	3,9
	RDKW 1003 MOS-MM	BCM40M	5117628	●	10	3,18	3,9
	RDKW 1003 MOS-MK	BCK15M	5086814	●	10	3,18	3,9
	RDKW 1003 MOS-MK	BCK20M	5079553	●	10	3,18	3,9
	RDHW 1003 MOS-MH	BCH03M	5117540	●	10	3,18	3,9
	RDHW 1003 MOS-MH	BCH05M	5147200	○	10	3,18	3,9
	RDHW 1003 MOS-MH	BCH10M	5147201	○	10	3,18	3,9
	RDHW 1003 MOS-RH	BCH30M	5147202	●	10	3,18	3,9
	RDKW 1003 MOS-MH	BCH05M	5117541	●	10	3,18	3,9
	RDKW 1003 MOS-MH	BCH10M	5117542	●	10	3,18	3,9
	RDKW 1003 MOS-RH	BCH30M	5117630	●	10	3,18	3,9

Bestellbeispiel Order example: 10 Stück pieces 5086933 oder or RDKW 1003 MOS-MP BCP20M

Die passenden Hartmetallverlängerungen finden Sie auf Seite 294

You will find the matching carbide extensions on page 294

Aufsteckfräser ISO 00P / RD.. 12
Face milling cutter ISO 00P / RD.. 12

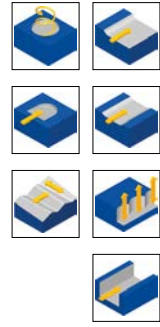
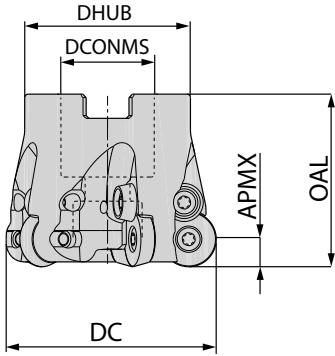

Abmessungen [mm] Dimension [mm]						Artikelbezeichnung Item code	Bestell-Nr. Ordering No.	Verfügbarkeit Availability		Ersatzteile Spare parts		
DC	DCONMS	DHUB	OAL	APMX	ZEFF \odot							
42	16	32	40	6	4	BF00 RD12.042 Z04	5116929	●	RD.. 12	Spannschraube Fixation screw AP13-35086 5118120 M _A = 3,5Nm	Torx-Schlüssel Torque wrench IP15 5088520	Spannschraube Clamping screw RD12 5125841
48	22	40	50	6	4	BF00 RD12.048 Z04	5116930	●				
50	22	40	50	6	5	BF00 RD12.050 Z05	5091167	●				
52	22	40	50	6	5	BF00 RD12.052 Z05	5100776	●				
63	27	48	50	6	6	BF00 RD12.063 Z06	5113559	●				
66	27	48	50	6	6	BF00 RD12.066 Z06	5116878	●				
80	27	60	52	6	7	BF00 RD12.080 Z07	5112570	●				

Aufsteckfräser ISO 00P / RD.. 12 / INCH
Face milling cutter ISO 00P / RD.. 12 / INCH

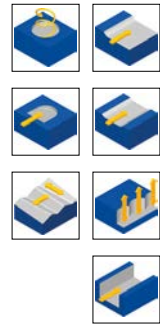
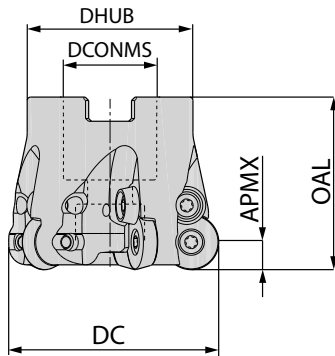

Abmessungen [INCH] Dimension [INCH]						Artikelbezeichnung Item code	Bestell-Nr. Ordering No.	Verfügbarkeit Availability		Ersatzteile Spare parts		
DC	DCONMS	DHUB	OAL	APMX	ZEFF \odot							
2.63	0.75	1.70	2.0	0.236	5	BFU00 RD12.2000 Z05	5133686	○	RD.. 12	Spannschraube Fixation screw AP13-35086 5118120 M _A = 3,5Nm	Torx-Schlüssel Torque wrench IP15 5088520	Spannschraube Clamping screw RD12 5125841
3.13	1.00	2.20	2.0	0.236	6	BFU00 RD12.2500 Z06	5133687	○				
3.63	1.00	2.30	2.0	0.236	7	BFU00 RD12.3000 Z07	5133688	○				

- Verfügbar ab Lager Available from stock
- ⦿ kurzfristig lieferbar available at short notice
- Lieferzeit auf Anfrage Delivery time on request

Bestellbeispiel Order example: 1 Stück piece 5116929 oder or BF00 RD12.042 Z04





ISO 00P

Systemgröße 12 System size 12

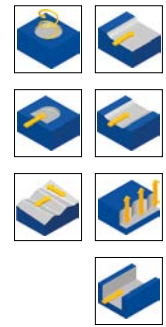
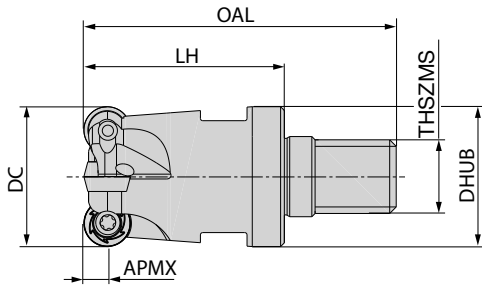
www.boehlerit.com





Einschraubfräser ISO 00P konisch Form A / RD.. 12 Screw on type ISO 00P conical form A / RD.. 12

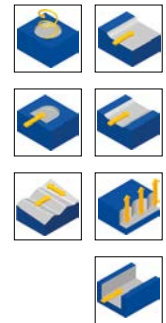
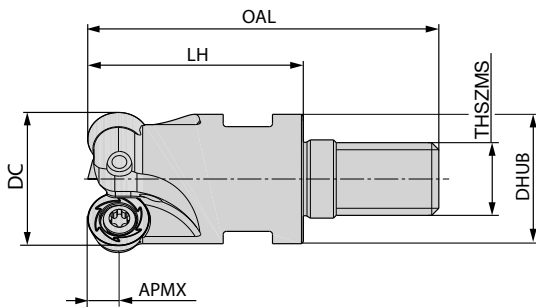

Abmessungen [mm] Dimensions [mm]							Artikelbezeichnung Item code	Bestell-Nr. Ordering No.	Verfügbarkeit Availability		Ersatzteile Spare parts		
DC	DHUB	LH	OAL	THSZMS	APMX	ZEFF [⊙]							
32	29	43	67	M16	6	3	BSA00 RD12.032 Z03 M16	5116925	●	RD.. 12	Spannschraube Fixation screw A13-35086 5118120 M _A = 3,5Nm	Torx-Schlüssel Torque wrench IP15 5088520	Spannschraube Clamping screw RD12 5125841

Einschraubfräser ISO 00P zylindrisch Form B / RD.. 12 Screw on type ISO 00P cylindrical form B / RD.. 12



Abmessungen [mm] Dimensions [mm]							Artikelbezeichnung Item code	Bestell-Nr. Ordering No.	Verfügbarkeit Availability		Ersatzteile Spare parts		
DC	DHUB	LU	OAL	THSZMS	APMX	ZEFF [⊙]							
24	21	33	55	M12	6	2	BSB00 RD12.024 Z02 M12	5151371	○	RD.. 12	Spannschraube Fixation screw AP13-35086 5118120 M _A = 3,5Nm	Torx-Schlüssel Torque wrench IP15 5088520	Spannschraube Clamping screw RD12 5125841
25	21	35	57	M12	6	2	BSB00 RD12.025 Z02 M12	5116924	●				
35	29	43	67	M16	6	3	BSB00 RD12.035 Z03 M16	5116926	●				
40	29	43	67	M16	6	2	BSB00 RD12.040 Z04 M16	5108612	●				
42	29	43	67	M16	6	4	BSB00 RD12.042 Z04 M16	5117020	●				

Bestellbeispiel Order example: 1 Stück piece 5116925 oder or BSA00 RD12.032 Z03 M16

Die passenden Hartmetallverlängerungen finden Sie auf Seite 294
You will find the matching carbide extensions on page 294

N = Anzahl der Schneidkanten N = Number of cutting edges	Artikelbezeichnung Item code	Schneidstoffsorte Cutting materials	Bestell-Nr. Ordering No.	Verfügbarkeit Availability	Abmessungen [mm] Dimensions [mm]		
					IC	S	D ₁
	RDKT 12T3 MOS-MP	BCP20M	5117644	●	12	3,97	3,9
	RDKT 12T3 MOS-MP	BCP25M	5117645	●	12	3,97	3,9
	RDKT 12T3 MOS-MP	BCP30M	5117648	●	12	3,97	3,9
	RDKT 12T3 MOS-MP	BCP35M	5117646	●	12	3,97	3,9
	RDHT 12T3 MO-MM	BCM35M	5107513	●	12	3,97	3,9
	RDHT 12T3 MO-MM	BCM40M	5107512	●	12	3,97	3,9
	RDKT 12T3 MOS-MM	BCM35M	5117650	●	12	3,97	3,9
	RDKT 12T3 MOS-MM	BCM40M	5117651	●	12	3,97	3,9
	RDHT 12T3 MO-MS	BCS35M	5171190	○	12	3,97	3,9
	RDKW 12T3 MOS-MP	BCP20M	5086939	●	12	3,97	3,9
	RDKW 12T3 MOS-MP	BCP25M	5086938	●	12	3,97	3,9
	RDKW 12T3 MOS-MP	BCP30M	5087036	●	12	3,97	3,9
	RDKW 12T3 MOS-MP	BCP35M	5086940	●	12	3,97	3,9
	RDKW 12T3 MOS-MK	BCK15M	5086937	○	12	3,97	3,9
	RDKW 12T3 MOS-MK	BCK20M	5079554	●	12	3,97	3,9
	RDHW 12T3 MOS-MH	BCH03M	5147203	●	12	3,97	3,9
	RDHW 12T3 MOS-MH	BCH05M	5147204	●	12	3,97	3,9
	RDHW 12T3 MOS-MH	BCH10M	5147205	○	12	3,97	3,9
	RDHW 12T3 MOS-RH	BCH30M	5147207	○	12	3,97	3,9
	RDKW 12T3 MOS-MH	BCH05M	5117633	●	12	3,97	3,9
	RDKW 12T3 MOS-MH	BCH10M	5117636	●	12	3,97	3,9
	RDKW 12T3 MOS-RH	BCH30M	5117641	●	12	3,97	3,9

- Verfügbar ab Lager Available from stock
- kurzfristig lieferbar available at short notice
- Lieferzeit auf Anfrage Delivery time on request

Bestellbeispiel Order example: 10 Stück pieces 5117644 oder or RDKT 12T3 MOS-MP BCP20M

Aufsteckfräser ISO 00P / RD.. 16 Face milling cutter ISO 00P / RD.. 16

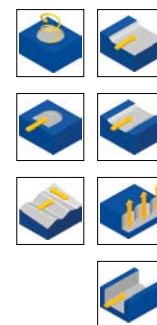
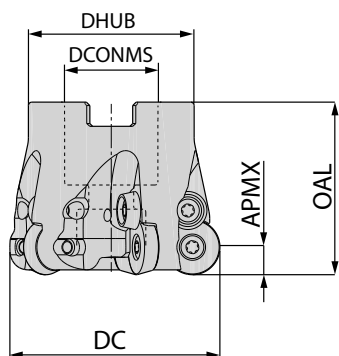

Abmessungen [mm] Dimension [mm]							Artikelbezeichnung Item code	Bestell-Nr. Ordering No.	Verfügbarkeit Availability		Ersatzteile Spare parts		
DC	DCX	DCONMS	DHUB	OAL	APMX	ZEFF							
34	50	22	40	50	8	4	BF00 RD16.050 Z04	5116881	●	RD.. 16	Spann- schraube Fixation screw AP13-45105 5118121 M _A = 5Nm	Torx- Schlüssel Torque wrench IP20 5088521	Spannsystem Clamping system: Klemm- platte Clamp 5125842 Spann- schraube Clamping screw 5118121
34	52	22	40	50	8	4	BF00 RD16.052 Z04	5116883	●				
47	63	27	48	50	8	5	BF00 RD16.063 Z05	5116884	●				
50	66	27	48	50	8	5	BF00 RD16.066 Z05	5098414	●				
50	66	27	48	50	8	6	BF00 RD16.066 Z06	5117184	○				
64	80	27	60	52	8	6	BF00 RD16.080 Z06	5095955	●				
64	80	27	60	52	8	7	BF00 RD16.080 Z07	5115222	○				
84	100	32	75	52	8	7	BF00 RD16.100 Z07	5116885	●				
109	125	40	90	63	8	8	BF00 RD16.125 Z08	5116886	●				
144	160	40	120	63	8	9	BF00 RD16.160 Z09	5116887	○				

Aufsteckfräser ISO 00P / RD.. 16 / INCH Face milling cutter ISO 00P / RD.. 16 / INCH

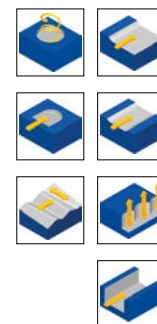
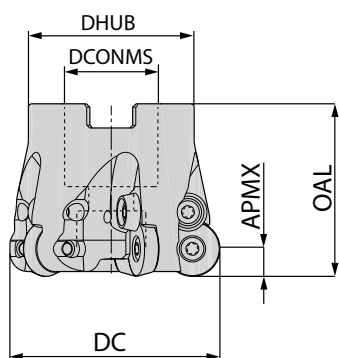

Abmessungen [mm] Dimension [mm]							Artikelbezeichnung Item code	Bestell-Nr. Ordering No.	Verfügbarkeit Availability		Ersatzteile Spare parts		
DC	DCX	DCONMS	DHUB	OAL	APMX	ZEFF							
2.0	2.63	0.75	1.70	2.0	0.315	4	BFU00 RD16.2000 Z04	5133689	○	RD.. 16	Spann- schraube Fixation screw AP13-45105 5118121 M _A = 5Nm	Torx- Schlüssel Torque wrench IP20 5088521	Spannsystem Clamping system: Klemm- platte Clamp 5125842 Spann- schraube Clamping screw 5118121
2.5	3.13	1.00	2.20	2.0	0.315	5	BFU00 RD16.2500 Z05	5133690	○				
3.0	3.63	1.00	2.30	2.0	0.315	6	BFU00 RD16.3000 Z06	5133691	○				
4.0	4.63	1.50	3.10	2.0	0.315	7	BFU00 RD16.4000 Z07	5133692	○				
5.0	5.63	1.50	3.50	2.5	0.315	8	BFU00 RD16.5000 Z08	5133693	○				

Bestellbeispiel Order example: 1 Stück piece 5116881 oder or BF00 RD16.050 Z04

Einschraubfräser ISO 00P konisch Form A / RD.. 16
Screw on type ISO 00P conical form A / RD.. 16

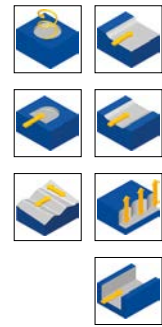
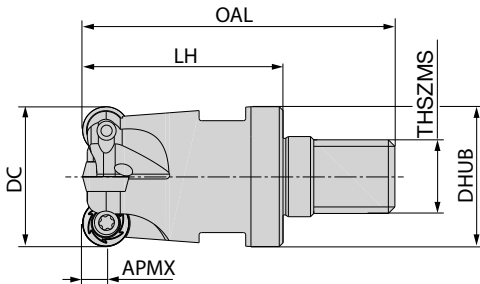

Abmessungen [mm] / Dimension [mm]							Artikelbezeichnung / Item code	Bestell-Nr. / Ordering No.	Verfügbarkeit / Availability		Ersatzteile Spare parts		
DC	DHUB	LH	OAL	THSZMS	APMX	ZEFF							
32	29	43	67	M16	8	2	BSA00 RD16.032 Z02 M16	5100845	●	RD.. 16	 Spannschraube / Fixation screw AP13-45105 5118121 M _A = 5Nm	 Torx-Schlüssel / Torque wrench IP20 5088521	 Spannsystem / Clamping system: Klemmplatte / Clamp 5125842 Spannschraube / Clamping screw 5118121

Einschraubfräser ISO 00P zylindrisch Form B / RD.. 16
Screw on type ISO 00P cylindrical form B / RD.. 16

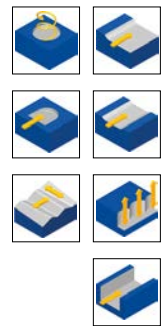
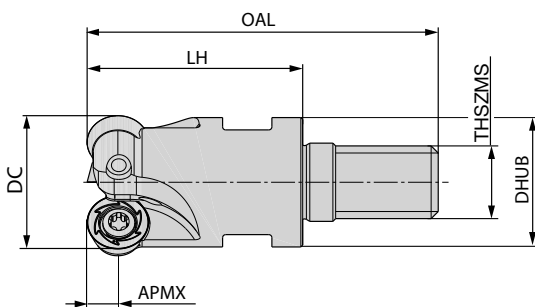

Abmessungen [mm] / Dimension [mm]							Artikelbezeichnung / Item code	Bestell-Nr. / Ordering No.	Verfügbarkeit / Availability		Ersatzteile Spare parts		
DC	DHUB	LH	OAL	THSZMS	APMX	ZEFF							
32	29	43	67	M16	8	2	BSB00 RD16.032 Z02 M16	5146580	○	RD.. 16	 Spannschraube / Fixation screw AP13-45105 5118121 M _A = 5Nm	 Torx-Schlüssel / Torque wrench IP20 5088521	 Spannsystem / Clamping system: Klemmplatte / Clamp 5125842 Spannschraube / Clamping screw 5118121
40	29	43	67	M16	8	2	BSB00 RD16.040 Z02 M16	5116927	●				

Bestellbeispiel Order example: 1 Stück piece 5100845 oder or BSA00 RD16.032 Z02 M16
Die passenden Hartmetallverlängerungen finden Sie auf Seite 294
You will find the matching carbide extensions on page 294

- Verfügbar ab Lager Available from stock
- kurzfristig lieferbar available at short notice
- Lieferzeit auf Anfrage Delivery time on request

ISO 00P

Systemgröße 16 System size 16

www.boehlerit.com

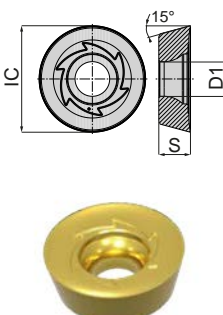
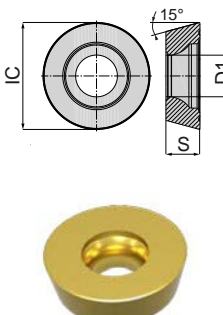
N = Anzahl der Schneidkanten N = Number of cutting edges	Artikelbezeichnung Item code	Schneidstoffsorte Cutting materials	Bestell-Nr. Ordering No.	Verfügbarkeit Availability	Abmessungen [mm] Dimensions [mm]		
					IC	S	D ₁
	RDKT 1604 MOS-MP	BCP20M	5117666	○	16	4,76	5,2
	RDKT 1604 MOS-MP	BCP25M	5117667	●	16	4,76	5,2
	RDKT 1604 MOS-MP	BCP30M	5117668	●	16	4,76	5,2
	RDKT 1604 MOS-MP	BCP35M	5117669	●	16	4,76	5,2
	RDKT 1604 MOS-MM	BCM35M	5117670	●	16	4,76	5,2
	RDKT 1604 MOS-MM	BCM40M	5117671	●	16	4,76	5,2
	RDHT 1604 MO-MS	BCS35M	5162343	●	16	4,76	5,2
	RDKW 1604 MOS-MP	BCP20M	5087042	●	16	4,76	5,2
	RDKW 1604 MOS-MP	BCP25M	5087040	●	16	4,76	5,2
	RDKW 1604 MOS-MP	BCP30M	5087050	●	16	4,76	5,2
	RDKW 1604 MOS-MP	BCP35M	5087044	●	16	4,76	5,2
	RDKW 1604 MOS-MK	BCK15M	5087039	●	16	4,76	5,2
	RDKW 1604 MOS-MK	BCK20M	5079555	●	16	4,76	5,2
	RDHW 1604 MOS-MH	BCH03M	5147208	●	16	4,76	5,2
	RDHW 1604 MOS-MH	BCH05M	5147209	●	16	4,76	5,2
	RDHW 1604 MOS-MH	BCH10M	5147210	●	16	4,76	5,2
	RDHW 1604 MOS-RH	BCH30M	5147211	●	16	4,76	5,2
	RDKW 1604 MOS-MH	BCH05M	5117662	●	16	4,76	5,2
	RDKW 1604 MOS-MH	BCH10M	5117663	●	16	4,76	5,2
	RDKW 1604 MOS-RH	BCH30M	5117665	●	16	4,76	5,2

Bestellbeispiel Order example: 10 Stück pieces 5117666 oder or RDKT 1604 MOS-MP BCP20M

- Verfügbar ab Lager Available from stock
- Lieferzeit auf Anfrage Delivery time on request

	Aufsteckfräser Face milling cutter	Schaftfräser End milling cutter	Einschraubfräser Screw on type
Ausführung Execution			
Durchmesserbereich metrisch Diameter range metric	Ø 40 - 80 mm	Ø 20 - 32 mm	Ø 25 - 40 mm
Plattengröße Insert size	RP.. 08, RP.. 12	RP.. 10	RP.. 08, RP.. 10

Besondere Merkmale:

- Speziell auf die Bearbeitung Kopierfräsen, abgestimmter Träger und Schneidstoffe
- Spezielles Design gegen Verdrehen der Wendeschneidplatten
- Zwei Grundgeometrien für optimale Performance, Ergebnisse
- Einfaches Handling dank spezieller Indexierung
- Ungleichteilung zur Schwingungsreduktion und für extreme Laufruhe
- Optimierte Spankammern für optimalen Späneabtransport
- Hohe Schnittdaten und hohe Zerspanungsvolumine realisierbar.
- Sehr gut geeignet für Turbinenschaufelbearbeitung!

Special features:

- Supports and cutting materials specially adapted to the machining of copy milling machines
- Special design against twisting of the insert
- Two basic geometries for optimal performance, results
- Simple handling due to special indexation
- Unequal division for reduction of vibration and for extreme smoothness
- Optimized chip chambers for optimal chip transport
- Big cutting data and cutting volume are possible
- Very well suited for turbine blade machining!

WSP Geometrie Insert geometry	RPMX 08		RPMX 10		RPMX 12	
	Schnitttiefe* Cutting depth* [mm] APMX max	Vorschub* Feed* [mm] fz	Schnitttiefe* Cutting depth* [mm] APMX max	Vorschub* Feed* [mm] fz	Schnitttiefe* Cutting depth* [mm] APMX max	Vorschub* Feed* [mm] fz
MS	0,25 1,0 2,0	0,15 0,22 0,5	0,3 0,75 1,25	0,14 0,23 0,55	0,5 1,25 2,0	0,18 0,25 0,6

Schnitttiefen variieren aufgrund Indexierung.
Depth of cut varies due to indexing.

Schnittwertempfehlungen siehe Seite 174
Cutting data recommendations page 174

* Angegebene Schnittdaten sind als Richtwert zu sehen, welche durch Versuche für jeden Anwendungsfall separat optimiert werden können.
* Recommended cutting data has to be seen as a reference which can be optimised for each application through trials separately.

VARIOfec 00P

Systemgröße 08 System size 08

www.boehlerit.com

Aufsteckfräser / RP.. 08 Face milling cutter / RP.. 08

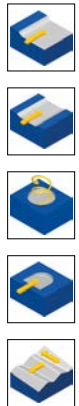
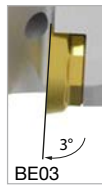
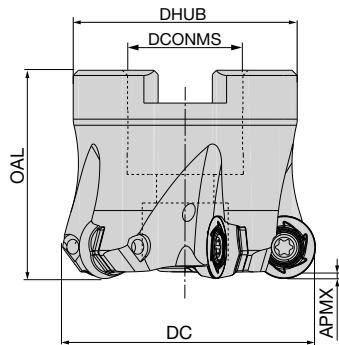

Abmessungen [mm] Dimensions [mm]						Artikelbezeichnung Item code	Bestell-Nr. Ordering No.	Verfügbarkeit Availability	Ersatzteile Spare parts	
DC	DCONMS	DHUB	OAL	APMX	ZEFF				Spann- schraube Fixation screw AP13-25055 5118117 M _A = 1,4Nm	Torx- Schlüssel Torque wrench IP9 5118124
40	16	35	40	2	6	BF03 RX08.040 Z06	5182672	○		

Einschraubfräser / RP.. 08 Screw on type / RP.. 08

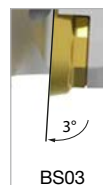
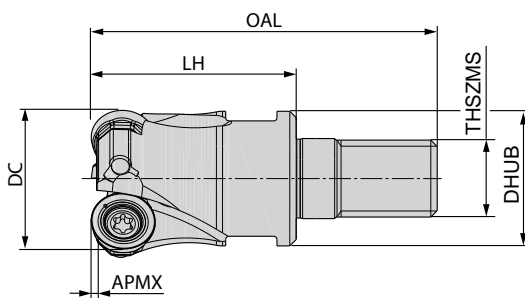



Abmessungen [mm] Dimensions [mm]								Artikelbezeichnung Item code	Bestell-Nr. Ordering No.	Verfügbarkeit Availability	Ersatzteile Spare parts	
DC	DCONMS	DHUB	LH	OAL	THSZMS	APMX	ZEFF				Spann- schraube Fixation screw AP13-25055 5118117 M _A = 1,4Nm	Torx- Schlüssel Torque wrench IP9 5118124
16	8	13,8	23	41	M8	2	2	BS03 RX08.016 Z02 M8	5224598	○		
20	10	18	30	49	M10	2	3	BS03 RX08.020 Z03 M10	5164867	○		
25	12	21	35	57	M12	2	4	BS03 RX08.025 Z04 M12	5224599	○		
32	16	29	43	66	M16	2	5	BS03 RX08.032 Z05 M16	5224600	○		

Bestellbeispiel Order example: 1 Stück piece 5182672 oder or BF03 RX08.040 Z06

VARIOTec 00P

Systemgröße 08 System size 08

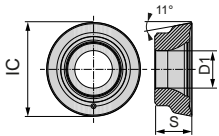

N = Anzahl der Schneidkanten N = Number of cutting edges	Artikelbezeichnung Item code	Schneidstoffsorte Cutting materials	Bestell-Nr. Ordering No.	Verfügbarkeit Availability	Abmessungen [mm] Dimensions [mm]		
					IC	S	D ₁
  CEDC = 4	RPMX 0802MO-MS	BCS35M	5169157	●	8	2,38	2,8
	RPMX 0802MO-MS	BCS40M	5169158	●	8	2,38	2,8

Bestellbeispiel Order example: 10 Stück pieces 5169157 oder or RPMX 0802MO-MS BCS35M

VARIOTec 00P

Systemgröße 10 System size 10

Aufsteckfräser / RP.. 10 Face milling cutter / RP.. 10						Artikelbezeichnung Item code	Bestell-Nr. Ordering No.	Verfügbarkeit Availability	Ersatzteile Spare parts	
DC	DCONMS	DHUB	OAL	APMX	ZEFF [☆]				Spannschraube Fixation screw AP13-35072 5118118 M _A = 3,5Nm	Torx-Schlüssel Torque wrench IP15 5088520
50	22	43	43	1,25	6	BF00 RX10.050 Z06	5176150	○		
42	16	35	40	1,25	6	BF03 RX10.042 Z06	5211759	●		

Bestellbeispiel Order example: 1 Stück piece 5176150 oder or BF00 RX10.050 Z06

- Verfügbar ab Lager Available from stock
- Lieferzeit auf Anfrage Delivery time on request

VARIOTec 00P

Systemgröße 10 System size 10

www.boehlerit.com

Schafffräser / RP.. 10 End milling cutter / RP.. 10

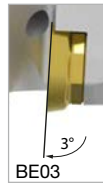
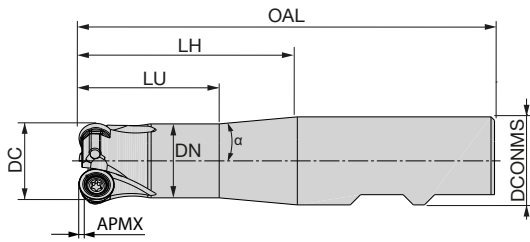

Abmessungen [mm] Dimensions [mm]									Artikelbezeichnung Item code	Schaft Shank	Bestell-Nr. Ordering-No	Verfügbarkeit Availability	Ersatzteile Spare parts	
DC	DCONMS	DN	LH	LU	α	OAL	APMX	ZEFF \odot						
20	20	18	50	50	0	100	1,25	2	BE03 RX10.020 Z02	HB	5175783	○	 	
25	25	21	60	39,8	10,2	118	1,25	3	BE03 RX10.025 Z03	HB	5165739	○		
25	25	21	60	39,8	10,2	225	1,25	3	BE03 RX10.025 Z03 225	HA	5176148	○		
32	32	27	62	36,3	10,2	124	1,25	4	BE03 RX10.032 Z04	HB	5176149	○		

Einschraubfräser / RP.. 10 Screw on type / RP.. 10

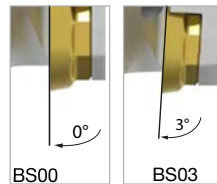
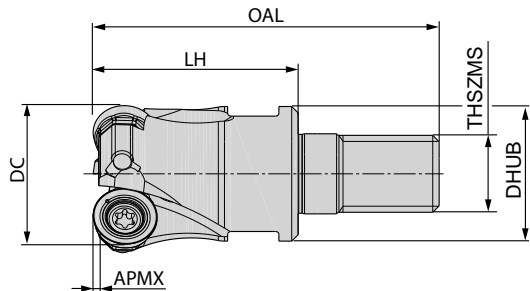

Abmessungen [mm] Dimensions [mm]						Artikelbezeichnung Item code	Bestell-Nr. Ordering No.	Verfügbarkeit Availability	Ersatzteile Spare parts	
DC	DHUB	OAL	THSZMS	APMX	ZEFF \odot					
32	29	40	M16	1,25	4	BS00 RX10.032 Z04 M16	5155234	○	 	
40	29	43	M16	1,25	5	BS00 RX10.040 Z05 M16	5165488	●		
25	21	32	M12	1,25	3	BS03 RX10.025 Z03 M12	5165742	●		
32	29	40	M16	1,25	4	BS03 RX10.032 Z04 M16	5157171	●		

Die passenden Hartmetallverlängerungen finden Sie auf Seite 294 You will find the matching carbide extensions on page 294

N = Anzahl der Schneidkanten N = Number of cutting edges	Artikelbezeichnung Item code	Schneidstoffsorte Cutting materials	Bestell-Nr. Ordering No.	Verfügbarkeit Availability	Abmessungen [mm] Dimensions [mm]		
					IC	S	D ₁
 CEDC = 8	RPMX 10T3M0-MS	BCS35M	5155839	●	10	3,97	3,9
	RPMX 10T3M0-MS	BCS40M	5167407	●	10	3,97	3,9

Bestellbeispiel Order example: 1 Stück piece 5155234 oder or BS00 RX10.032 Z04 M16

● Verfügbar ab Lager Available from stock
○ Lieferzeit auf Anfrage Delivery time on request

Aufsteckfräser / RP.. 12
Face milling cutter / RP.. 12

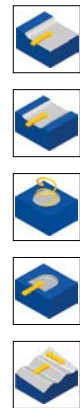
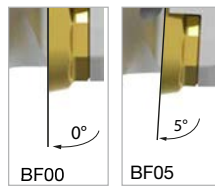
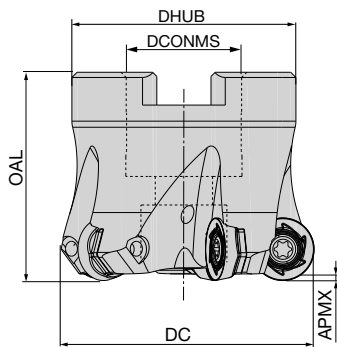

Abmessungen [mm] Dimensions [mm]						Artikelbezeichnung Item code	Bestell-Nr. Ordering No.	Verfügbarkeit Availability	Ersatzteile Spare parts	
DC	DCONMS	DHUB	OAL	APMX	ZEFF [☆]				Spannschraube Fixation screw AP13-35086 5118120 M _A = 3,5Nm	Torx-Schlüssel Torque wrench IP15 5088520
40	16	35	40	2	4	BF00 RX12.040 Z04	5171474	○		
42	16	35	40	2	4	BF00 RX12.042 Z04	5155233	○		
50	22	43	40	2	5	BF00 RX12.050 Z05	5154198	●		
52	22	43	40	2	5	BF00 RX12.052 Z05	5154191	●		
63	22	48	40	2	6	BF00 RX12.063 Z06	5160217	○		
80	27	60	50	2	8	BF00 RX12.080 Z08	5160219	○		
40	16	35	40	2	4	BF05 RX12.040 Z04	5157170	○		
50	22	43	40	2	5	BF05 RX12.050 Z05	5154202	○		
52	22	43	40	2	5	BF05 RX12.052 Z05	5154193	●		
63	22	48	40	2	6	BF05 RX12.063 Z06	5160218	●		
80	27	60	50	2	8	BF05 RX12.080 Z08	5160220	●		

Bestellbeispiel Order example: 1 Stück piece 5171474 oder or BF00 RX12.040 Z04

N = Anzahl der Schneidkanten N = Number of cutting edges	Artikelbezeichnung Item code	Schneidstoffsorte Cutting materials	Bestell-Nr. Ordering No.	Verfügbarkeit Availability	Abmessungen [mm] Dimensions [mm]		
					IC	S	D ₁
 CEDC = 6	RPMX 1204M0-MS	BCS35M	5154658	●	12	4,76	3,9
	RPMX 1204M0-MS	BCS40M	5167406	●	12	4,76	3,9

Bestellbeispiel Order example: 10 Stück pieces 5154658 oder or RPMX 1204M0-MS BCS35M

- Verfügbar ab Lager Available from stock
- Lieferzeit auf Anfrage Delivery time on request

ISO 513	BZG	Kühlung Cooling			Schnittdaten v _c [m/min] Cutting data v _c [m/min]				
		MMS/Luft MMS/Air	Trocken Dry	Nass Wet	BCP20M BCP25M	BCP30M BCP35M BCP40M	BCM35M	BCM40M	
		Vc = m/min							
P	P1	●	●	●	210 - 350	180 - 310	---	200 - 310	
	P2	●	●	●	170 - 300	160 - 240	---	160 - 265	
	P3	●	●	●	140 - 230	120 - 190	---	130 - 205	
	P4	●	●	●	120 - 190	110 - 180	---	120 - 180	
	P5	●	●	●	140 - 240	120 - 205	---	130 - 220	
M	M1	●	●	●	100 - 180	---	120 - 215	110 - 190	
	M2	●	●	●	70 - 130	---	80 - 155	70 - 145	
K	K1	●	●		200 - 340	---	---	---	
	K2	●	●		130 - 220	---	---	---	
	K3	●	●		160 - 255	---	---	---	
N	N1		●	●	---	---	---	---	
	N2		●	●	---	---	---	---	
	N3		●	●	---	---	---	---	
	N4		●	●	---	---	---	---	
S	S1		●	●	---	---	70 - 115	55 - 95	
	S2		●	●	---	---	35 - 55	25 - 50	
	S3		●	●	---	---	50 - 125	30 - 90	
	S4		●	●	---	---	30 - 100	25 - 65	
H	H1	45 - 54 HRC	●	●	---	---	100 - 150	---	
	H2	55 - 63 HRC	●	●	---	---	80 - 130	---	
	H3	64 - 66 HRC	●	●	---	---	---	---	
	H4	50 - 60 HRC	●	●	---	---	90 - 140	---	

- empfohlene Anwendung recommended application
- alternative Anwendung um 30 - 50 % reduzieren
alternative application reduced by 30 - 50 % reduced

Schnittdaten v_c [m/min] Cutting data v_c [m/min]							
	BCK15M BCK20M	BWN10M	BCN10M	BCS35M BCS40M	BCH13M BCH23M	BCH05M BCH10M	BCH30M
	220 - 335	---	---	---	280 - 500	260 - 440	230 - 380
	190 - 290	---	---	---	240 - 450	220 - 400	200 - 350
	150 - 230	---	---	---	200 - 400	180 - 360	170 - 320
	---	---	---	---	---	---	---
	140 - 240	---	---	---	190 - 410	170 - 370	160 - 330
	---	---	---	100 - 180	---	---	---
	---	---	---	70 - 130	---	---	---
	220 - 410	---	---	---	320 - 560	280 - 490	220 - 420
	150 - 230	---	---	---	180 - 380	160 - 310	140 - 240
	170 - 290	---	---	---	230 - 410	220 - 330	200 - 310
	---	1200 - 2400	1500 - 3000	---	---	---	---
	---	240 - 550	310 - 750	---	---	---	---
	---	120 - 380	160 - 480	---	---	---	---
	---	400 - 500	600 - 800	---	---	---	---
	---	---	---	65 - 100	---	---	---
	---	---	---	30 - 70	---	---	---
	---	---	---	40 - 115	---	---	---
	---	---	---	30 - 90	---	---	---
	100 - 150	---	---	---	120 - 240	110 - 190	100 - 165
	80 - 130	---	---	---	100 - 180	90 - 155	80 - 140
	---	---	---	---	80 - 155	70 - 130	---
	90 - 140	---	---	---	110 - 190	100 - 180	90 - 150

PREMIUMLINE

Thermische Werkzeugspannung trifft Industrie 4.0
 Thermal Tool clamping meets industry 4.0

Vortreffliche Werkzeugspannung innerhalb weniger Sekunden im digitalen Prozess mit maximaler Sicherheit für den Anwender und den Prozess – diese Lösung bietet Premiumline mit höchstem Bedienkomfort und exklusiven Features in exquisiter Ausführung:

- Längenvoreinstellung
- Touchdisplay
- TDSC Reader + Software
- QR & Barcode Scanner
- Pole Disc Sensor
- Wechselspulen
- Druckluft-Feinfilter
- Ablagetisch mit Corianplatte

Optionale:

- Luftreinigung
- Sicherheitsabschaltung

Excellent tool clamping within a few seconds in the digital process with maximum security for the users and the process - Premiumline offers this solution with maximum ease of use and exclusive features in exquisite execution:

- Length presetting
- Touch display
- TDSC Reader + Software
- QR & Barcode Scanner
- Pole Disc Sensor
- Interchangeable coils
- Compressed air fine filter
- Storage table with Corian Plate

Optional:

- Air pollution control
- Safety shutdown

Spannbereich Clamping range HM 3 - 50 mm
 Spannbereich Clamping range HSS 6 - 50 mm



**SICHER
 SCHNELL
 EFFIZIENT**

boehlerit

Vollhartmetall
Fräswerkzeuge
Solid carbide milling tools



Allgemeine Anwendungen General machining



Fräswerkzeuge für Vollnuten und den allgemeinen Anwendungsfall
End milling cutters for full slots and general machining application

Ø 1 - 25 mm Ø 1 - 25 mm
Standard und Professional Linie Standard and Professional line
Verschiedene Ausführungen erhältlich Many executions available

Hohe Standzeiten High tool life
Optimaler Späneabtransport Optimized chip transportation

Seite 182 Page 182

Eckfräsen - Schruppen Edge milling - Roughing



Fräswerkzeuge für hohe Zerspanungsvolumina beim Schruppen
End milling cutters for high removal rates on roughing

Ø 4 - 25 mm Ø 4 - 25 mm
Professional Linie Professional line
Kurze und lange Ausführungen erhältlich
Short and long executions available
Spezielle HPC- Schruppverzahnung Special HPC- geometry
Ungleichteilung gegen Vibrationen
Unequal division against vibrations

Seite 216 Page 216

Eckfräsen - Schlichten Edge milling - Finishing



Fräswerkzeuge für höchste Oberflächengüten
End milling cutters for excellent surface qualities

Ø 4 - 25 mm Ø 4 - 25 mm
Standard und Professional Linie Standard and professional line
Auch für harte Werkstoffe erhältlich Also for hardened materials
Optimierte Zähneanzahl Optimized teeth amount
Verschiedene Schneidkantenausführungen erhältlich
Different edge executions available

Seite 228 Page 228

Trochoidal Fräsen Trochoidal milling



Fräswerkzeuge für höchste Zerspanungsraten bei hohen Oberflächengüten
End milling cutters for highest removal rates paired with high surface qualities

Ø 4 - 25 mm Ø 4 - 25 mm
Professional Linie Professional line
Ungleichteilung Unequal division
Gewuchtet nach DIN ISO 1940-G2.5 Heaved acc. DIN ISO 1940-G2.5
Hohe Schnitttiefen möglich High depth of cuts possible

Seite 238 Page 238

3D Fräsen 3D Milling



Fräswerkzeuge für den Gesenk- und Formenbau
End milling cutters for mould and die

Ø 0,4 - 20 mm Ø 0,4 - 20 mm
Für weiche und harte Werkstoffe For soft and hardened materials
Professional Linie Professional line
Hohe Rundlaufgenauigkeiten High concentricity
Sehr hohe Laufruhe Excellent running behaviour
Hochvorschubfräser High feed cutters

Seite 249 Page 249

Fasbearbeitung, Entgraten Chamfering, deburring



Fräswerkzeuge für Fasbearbeitung
End milling cutters for chamfering

Ø 4 - 20 mm Ø 4 - 20 mm
Standard Linie Standard line
Entgraten und Senken 90° Chamfering and spotting 90°

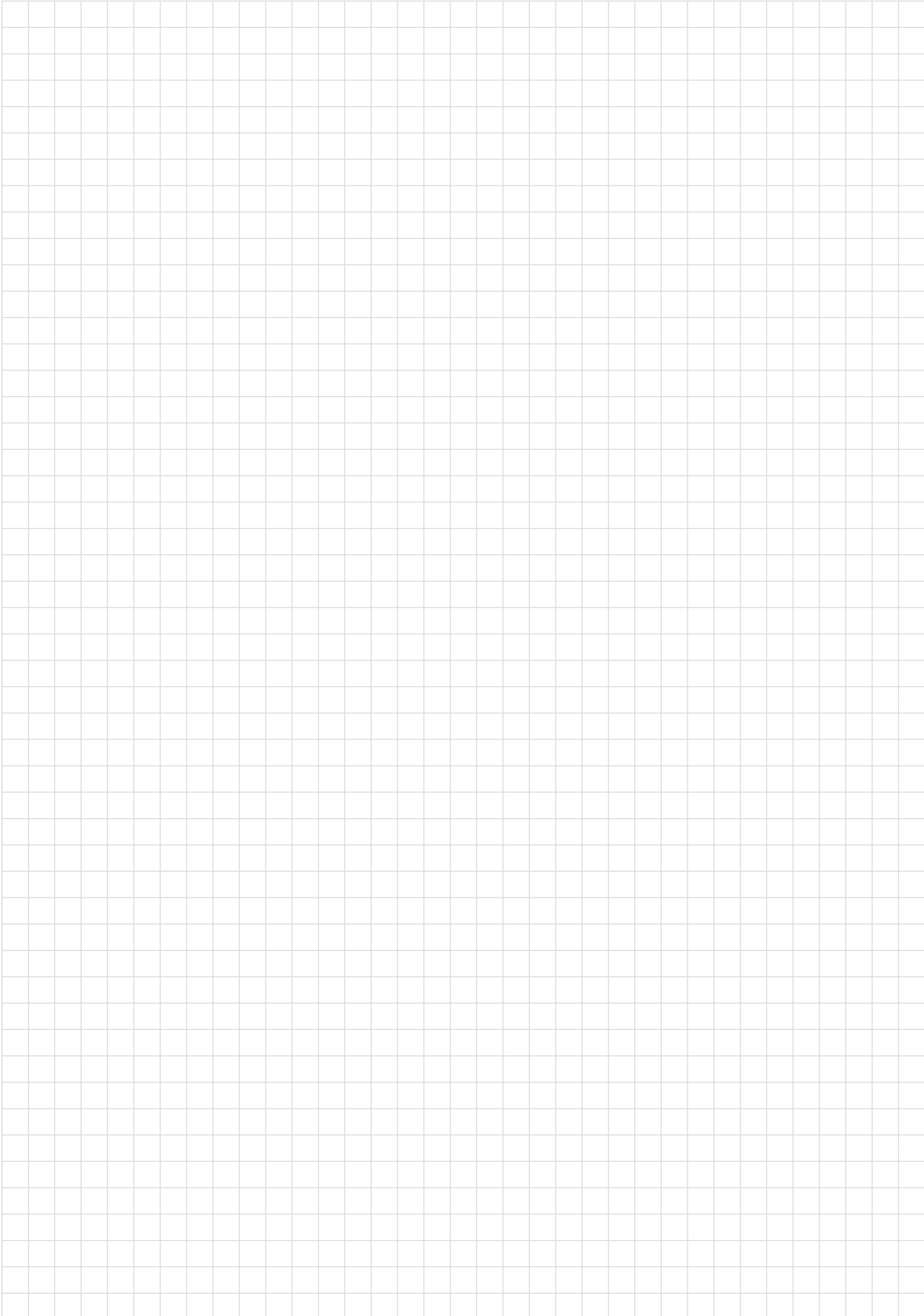

Seite 290 Page 290



boehlerit

Allgemeine Anwendungen
und Nutfräsen
General machining
and slot milling



Allgemeine Anwendungen General machining			
	UNIttec	UNIttec Pro	MULTIttec
			
Zähnezahl Amount teeth	Z2, Z3, Z4	Z3, Z4, Z5	Z3
P.1	■	■	■
P.2	■	■	■
P.3	■	■	■
P.4	■	■	■
P.5	■	■	■
P.6	■	■	■
M.1	■	■	■
M.2	■	■	■
K.1	■	■	■
K.2	■	■	■
K.3	□	■	■
N.1	■	■	■
N.2	■	■	■
N.3	■	■	■
N.4	□	□	□

UNIttec short

Kurze Ausführung Z3

Execution short Z3

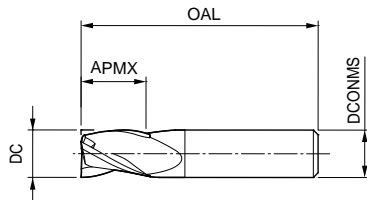

Hard Facts	
Fräserdurchmesser:	2,50 - 16,00 mm
Beschichtung:	TiAlN PVD
Schneidenzahl:	Z = 3
Drallwinkel:	30°
Diameter:	2.50 - 16.00 mm
Coating:	TiAlN PVD
Amount/Teeth:	Z = 3
Helix angle:	30°

UNIttec short		
ISO		
P	P.1	■
	P.2	■
	P.3	■
	P.4	■
	P.5	■
M	M.1	□
	M.2	□
K	K.1	■
	K.2	■
	K.3	□
N	N.1	■
	N.2	■
	N.3	□

Artikelbezeichnung Item Code	Bestell-Nr. Ordering No.	Verfügbarkeit Availability	Abmessungen [mm] Dimensions [mm]				ZEFF [☆]	Schaft Shank
			DC	DCONMS	OAL	APMX		
U02.5.004.040 SH Z3 HA	5162703	●	2,50	6,00	40,00	4,00	3	HA
U03.005.040 SH Z3 HA	5162728	●	3,00	6,00	40,00	5,00	3	HA
U03.5.005.040 SH Z3 HA	5162730	●	3,50	6,00	40,00	5,00	3	HA
U04.007.040 SH Z3 HA	5162731	●	4,00	6,00	40,00	7,00	3	HA
U04.5.007.040 SH Z3 HA	5162733	●	4,50	6,00	40,00	7,00	3	HA
U05.008.040 SH Z3 HA	5162736	●	5,00	6,00	40,00	8,00	3	HA
U05.5.008.040 SH Z3 HA	5162738	●	5,50	6,00	40,00	8,00	3	HA
U05.75.008.040 SH Z3 HA	5162740	○	*5,75	6,00	40,00	8,00	3	HA
U06.008.040 SH Z3 HA	5162742	●	6,00	6,00	40,00	8,00	3	HA
U06.75.011.043 SH Z3 HA	5162744	○	*6,75	8,00	43,00	11,00	3	HA
U07.011.043 SH Z3 HA	5162746	●	7,00	8,00	43,00	11,00	3	HA
U07.75.011.043 SH Z3 HA	5162747	●	*7,75	8,00	43,00	11,00	3	HA
U08.011.043 SH Z3 HA	5162748	●	8,00	8,00	43,00	11,00	3	HA
U08.7.013.050 SH Z3 HA	5162749	○	8,70	10,00	50,00	13,00	3	HA
U09.013.050 SH Z3 HA	5162750	○	9,00	10,00	50,00	13,00	3	HA
U09.7.013.050 SH Z3 HA	5162752	○	*9,70	10,00	50,00	13,00	3	HA
U10.013.050 SH Z3 HA	5162754	●	10,00	10,00	50,00	13,00	3	HA
U12.015.055 SH Z3 HA	5162755	●	12,00	12,00	55,00	15,00	3	HA
U14.015.058 SH Z3 HA	5162756	○	14,00	14,00	58,00	15,00	3	HA
U16.018.062 SH Z3 HA	5162758	●	16,00	16,00	62,00	18,00	3	HA

Bestellbeispiel Order example: 1 Stück piece 5162703 oder or U02.5.004.040 SH Z3 HA

Genaue Schnitzwertempfehlung siehe Seite 206

Detailed cutting recommendations, see page 206

* Untermaßgrößen speziell zum Passnutfräsen

* Undersize execution especially for keyway milling

● Verfügbar ab Lager Available from stock

● Kurzfristig lieferbar Available at short notice

○ Lieferzeit auf Anfrage Delivery time on request

UNitec short

Kurze Ausführung Z4

Execution short Z4

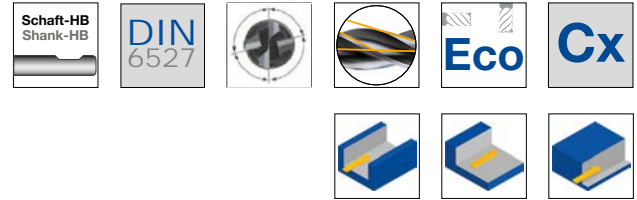
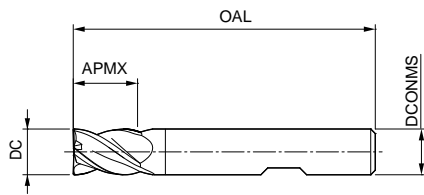

Hard Facts	
Fräserdurchmesser:	3,00 - 20,00 mm
Beschichtung:	AlTiN PVD
Schneidenzahl:	Z = 4
Drallwinkel:	36°/38,5°
Besonderheiten:	Ungleichteilung
Diameter:	3.00 - 20.00 mm
Coating:	AlTiN PVD
Amount/Teeth:	Z = 4
Helix angle:	36°/38,5°
Special feature:	Unequal division

UNitec short		
ISO		
P	P.1	■
	P.2	■
	P.3	■
	P.4	■
	P.5	■
M	M.1	■
	M.2	■
K	K.1	■
	K.2	■
	K.3	□

Artikelbezeichnung Item Code	Bestell-Nr. Ordering No.	Verfügbarkeit Availability	Abmessungen [mm] Dimensions [mm]					ZEFF [☆]	Schaft Shank
			DC	DCONMS	OAL	APMX	Cx 45°		
U03.006.050 Cx Z4 HB	5162762	●	3,00	6,00	50,00	6,00	0,06	4	HB
U04.008.054 Cx Z4 HB	5162763	●	4,00	6,00	54,00	8,00	0,08	4	HB
U05.009.054 Cx Z4 HB	5162765	●	5,00	6,00	54,00	9,00	0,10	4	HB
U06.010.054 Cx Z4 HB	5162766	●	6,00	6,00	54,00	10,00	0,12	4	HB
U08.012.058 Cx Z4 HB	5162769	●	8,00	8,00	58,00	12,00	0,16	4	HB
U10.014.066 Cx Z4 HB	5162770	●	10,00	10,00	66,00	14,00	0,20	4	HB
U12.016.073 Cx Z4 HB	5162771	●	12,00	12,00	73,00	16,00	0,24	4	HB
U14.016.073 Cx Z4 HB	5162772	●	14,00	14,00	73,00	16,00	0,28	4	HB
U16.022.082 Cx Z4 HB	5162777	●	16,00	16,00	82,00	22,00	0,32	4	HB
U18.022.082 Cx Z4 HB	5162780	●	18,00	18,00	82,00	22,00	0,36	4	HB
U20.026.092 Cx Z4 HB	5162784	●	20,00	20,00	92,00	26,00	0,40	4	HB

Bestellbeispiel Order example: 1 Stück piece 5162762 oder or U03.006.050 Cx Z4 HB

Genauere Schnittwertempfehlung siehe Seite 206

Detailed cutting recommendations, see page 206

UNItec Pro short

Kurze Ausführung Z4
Execution short Z4

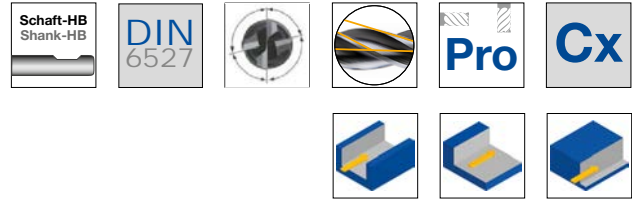
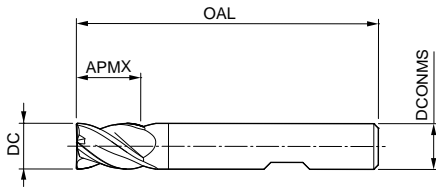

Hard Facts	
Fräserdurchmesser:	3,00 - 20,00 mm
Beschichtung:	AlCrN PVD
Schneidenzahl:	Z = 4
Drallwinkel:	36°/38°
Besonderheiten:	Ungleichteilung
Diameter:	3.00 - 20.00 mm
Coating:	AlCrN PVD
Amount/Teeth:	Z = 4
Helix angle:	36°/38°
Special feature:	Unequal division

UNItec Pro short		
ISO		
P	P.1	■
	P.2	■
	P.3	■
	P.4	■
	P.5	■
M	M.1	■
	M.2	■
K	K.1	■
	K.2	■
	K.3	■

Artikelbezeichnung Item Code	Bestell-Nr. Ordering No.	Verfügbarkeit Availability	Abmessungen [mm] Dimensions [mm]					ZEFF [⊙]	Schaft Shank
			DC	DCONMS	OAL	APMX	Cx 45°		
UP03.006.050 Cx Z4 HB	●	5162941	3,00	6,00	50,00	6,00	0,06	4	HB
UP04.008.054 Cx Z4 HB	●	5162944	4,00	6,00	54,00	8,00	0,08	4	HB
UP05.009.054 Cx Z4 HB	●	5162945	5,00	6,00	54,00	9,00	0,10	4	HB
UP06.010.054 Cx Z4 HB	●	5162947	6,00	6,00	54,00	10,00	0,12	4	HB
UP08.012.058 Cx Z4 HB	●	5162948	8,00	8,00	58,00	12,00	0,16	4	HB
UP10.014.066 Cx Z4 HB	●	5162949	10,00	10,00	66,00	14,00	0,20	4	HB
UP12.016.073 Cx Z4 HB	●	5162954	12,00	12,00	73,00	16,00	0,24	4	HB
UP14.016.073 Cx Z4 HB	⊙	5163145	14,00	14,00	73,00	16,00	0,28	4	HB
UP16.022.082 Cx Z4 HB	●	5162958	16,00	16,00	82,00	22,00	0,32	4	HB
UP18.022.082 Cx Z4 HB	⊙	5163146	18,00	18,00	82,00	22,00	0,36	4	HB
UP20.026.092 Cx Z4 HB	⊙	5163147	20,00	20,00	92,00	26,00	0,40	4	HB

Bestellbeispiel Order example: 1 Stück piece 5162941 oder or UP03.006.050 Cx Z4 HB
 Genaue Schnittwertempfehlung siehe Seite 208
 Detailed cutting recommendations, see page 208

- Verfügbar ab Lager Available from stock
- ⊙ Kurzfristig lieferbar Available at short notice
- Lieferzeit auf Anfrage Delivery time on request

UNItec long

Lange Ausführung Z2
Execution long Z2

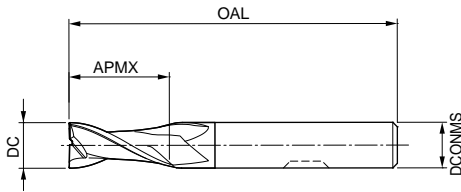

Hard Facts	
Fräserdurchmesser:	1,00 - 20,00 mm
Beschichtung:	TiAlN PVD
Schneidenzahl:	Z = 2
Drallwinkel:	30°
Diameter:	1.00 - 20.00 mm
Coating:	TiAlN PVD
Amount/Teeth:	Z = 2
Helix angle:	30°

UNItec long		
ISO		
P	P.1	■
	P.2	■
	P.3	■
	P.4	■
	P.5	■
M	M.1	□
	M.2	□
K	K.1	■
	K.2	■
	K.3	□
N	N.1	□
	N.2	□
	N.3	□

Artikelbezeichnung Item Code	Bestell-Nr. Ordering No.	Verfügbarkeit Availability	Abmessungen [mm] Dimensions [mm]					ZEFF [⊙]	Schaft Shank
			DC	DCONMS	OAL	APMX	Cx 45°		
U01.003.050 SH Z2 HA	5162785	●	1,00	3,00	50,00	3,00	-	2	HA
U01.5.004.050 SH Z2 HA	5162787	●	1,50	3,00	50,00	4,00	-	2	HA
U02.005.050 SH Z2 HA	5162788	●	2,00	3,00	50,00	5,00	-	2	HA
U02.5.006.050 SH Z2 HA	5162789	●	2,50	3,00	50,00	6,00	-	2	HA
U03.008.057 Cx Z2 HB	5162790	●	3,00	6,00	57,00	8,00	0,03	2	HB
U04.011.057 Cx Z2 HB	5162792	●	4,00	6,00	57,00	11,00	0,04	2	HB
U05.013.057 Cx Z2 HB	5162793	●	5,00	6,00	57,00	13,00	0,05	2	HB
U06.013.057 Cx Z2 HB	5162794	●	6,00	6,00	57,00	13,00	0,06	2	HB
U07.019.063 Cx Z2 HB	5162795	○	7,00	8,00	63,00	19,00	0,07	2	HB
U08.019.063 Cx Z2 HB	5162796	●	8,00	8,00	63,00	19,00	0,08	2	HB
U09.022.072 Cx Z2 HB	5162797	○	9,00	10,00	72,00	22,00	0,09	2	HB
U10.022.072 Cx Z2 HB	5162799	●	10,00	10,00	72,00	22,00	0,10	2	HB
U12.026.083 Cx Z2 HB	5162801	●	12,00	12,00	83,00	26,00	0,12	2	HB
U14.026.083 Cx Z2 HB	5162813	○	14,00	14,00	83,00	26,00	0,14	2	HB
U16.032.092 Cx Z2 HB	5162814	○	16,00	16,00	92,00	32,00	0,16	2	HB
U20.038.104 Cx Z2 HB	5162815	●	20,00	20,00	104,00	38,00	0,20	2	HB

Bestellbeispiel Order example: 1 Stück piece 5162785 oder or U01.003.050 SH Z2 HA

Genaue Schnittwertempfehlung siehe Seite 206

Detailed cutting recommendations, see page 206

UNItec long

Lange Ausführung Z3
Execution long Z3

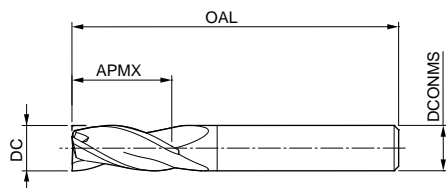

Hard Facts	
Fräserdurchmesser:	3,00 - 16,00 mm
Beschichtung:	TiAIN PVD
Schneidenzahl:	Z = 3
Drallwinkel:	30°
Diameter:	3.00 - 16.00 mm
Coating:	TiAIN PVD
Amount/Teeth:	Z = 3
Helix angle:	30°

UNItec long		
ISO		
P	P.1	■
	P.2	■
	P.3	■
	P.4	■
	P.5	■
M	M.1	□
	M.2	□
K	K.1	■
	K.2	■
	K.3	□
N	N.1	□
	N.2	□
	N.3	□

Artikelbezeichnung Item Code	Bestell-Nr. Ordering No.	Verfügbarkeit Availability	Abmessungen [mm] Dimensions [mm]				ZEFF [☆]	Schaft Shank
			DC	DCONMS	OAL	APMX		
U03.008.057 SH Z3 HA	5162816	●	3,00	6,00	57,00	8,00	3	HA
U03.8.011.057 SH Z3 HA	5162817	●	*3,80	6,00	57,00	11,00	3	HA
U04.011.057 SH Z3 HA	5162818	●	4,00	6,00	57,00	11,00	3	HA
U04.8.013.057 SH Z3 HA	5162819	●	*4,80	6,00	57,00	13,00	3	HA
U05.013.057 SH Z3 HA	5162820	●	5,00	6,00	57,00	13,00	3	HA
U05.8.013.057 SH Z3 HA	5162821	●	*5,80	6,00	57,00	13,00	3	HA
U06.013.057 SH Z3 HA	5162822	●	6,00	6,00	57,00	13,00	3	HA
U06.8.016.063 SH Z3 HA	5162823	●	*6,80	8,00	63,00	16,00	3	HA
U07.016.063 SH Z3 HA	5162824	●	7,00	8,00	63,00	16,00	3	HA
U07.8.019.063 SH Z3 HA	5162825	●	*7,80	8,00	63,00	19,00	3	HA
U08.019.063 SH Z3 HA	5162828	●	8,00	8,00	63,00	19,00	3	HA
U08.7.019.072 SH Z3 HA	5162830	○	*8,70	10,00	72,00	19,00	3	HA
U09.019.072 SH Z3 HA	5162831	○	9,00	10,00	72,00	19,00	3	HA
U09.7.022.072 SH Z3 HA	5162832	●	*9,70	10,00	72,00	22,00	3	HA
U10.022.072 SH Z3 HA	5162833	●	10,00	10,00	72,00	22,00	3	HA
U10.7.026.083 SH Z3 HA	5162834	○	*10,70	12,00	83,00	26,00	3	HA
U11.026.083 SH Z3 HA	5162835	●	11,00	12,00	83,00	26,00	3	HA
U11.7.026.083 SH Z3 HA	5162836	○	*11,70	12,00	83,00	26,00	3	HA
U12.026.083 SH Z3 HA	5162837	●	12,00	12,00	83,00	26,00	3	HA
U13.7.026.083 SH Z3 HA	5162838	○	*13,70	14,00	83,00	26,00	3	HA
U14.026.083 SH Z3 HA	5162839	●	14,00	14,00	83,00	26,00	3	HA
U15.7.032.092 SH Z3 HA	5162840	○	*15,70	16,00	92,00	32,00	3	HA
U16.032.092 SH Z3 HA	5162841	●	16,00	16,00	92,00	32,00	3	HA

Bestellbeispiel Order example: 1 Stück piece 5162816 oder or U03.008.057 SH Z3 HA

Genauere Schnittwertempfehlung siehe Seite 206

Detailed cutting recommendations, see page 206

* Untermaßgrößen speziell zum Passnutfräsen

* Undersize execution especially for keyway milling

● Verfügbar ab Lager Available from stock

● Kurzfristig lieferbar Available at short notice

○ Lieferzeit auf Anfrage Delivery time on request

UNIttec long neck

Lange Ausführung mit Hals Z3

Execution long neck Z3

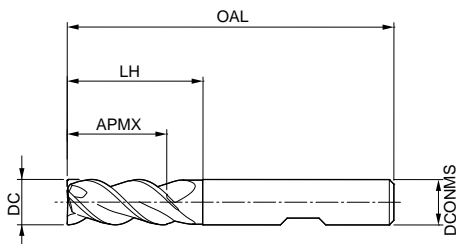

Hard Facts	
Fräserdurchmesser:	1,00 - 16,00 mm
Beschichtung:	TiAlN PVD
Schneidenzahl:	Z = 3
Drallwinkel:	45°
Diameter:	1.00 - 16.00 mm
Coating:	TiAlN PVD
Amount/Teeth:	Z = 3
Helix angle:	45°

UNIttec long neck		
ISO		
P	P.1	■
	P.2	■
	P.3	■
	P.4	■
	P.5	■
M	M.1	□
	M.2	□
K	K.1	■
	K.2	■
	K.3	□
N	N.1	□
	N.2	□
	N.3	□

Artikelbezeichnung Item Code	Bestell-Nr. Ordering No.	Verfügbarkeit Availability	Abmessungen [mm] Dimensions [mm]						ZEFF [☆]	Schaft Shank
			DC	DCONMS	OAL	APMX	LH	Cx 45°		
U01.002.038 SH Z3 HA	5162842	●	*1,00	3,00	38,00	2,00	-	-	3	HA
U01.5.003.038 SH Z3 HA	5162844	●	*1,50	3,00	38,00	3,00	-	-	3	HA
U02.004.054 SH Z3 HA	5162846	●	*2,00	3,00	54,00	4,00	-	-	3	HA
U02.5.006.054 SH Z3 HB	5162847	●	*2,50	6,00	54,00	6,00	-	-	3	HB
U03.008.057 Cx Z3 HB	5162849	●	*3,00	6,00	57,00	8,00	-	0,05	3	HB
U04.011.057 Cx Z3 HB	5162850	●	*4,00	6,00	57,00	11,00	-	0,06	3	HB
U05.013.057 Cx Z3 HB	5162851	●	*5,00	6,00	57,00	13,00	-	0,08	3	HB
U06.013.057 Cx Z3 HB	5162854	●	6,00	6,00	57,00	13,00	20,00	0,09	3	HB
U08.019.063 Cx Z3 HB	5162855	●	8,00	8,00	63,00	19,00	25,00	0,12	3	HB
U10.022.072 Cx Z3 HB	5162856	●	10,00	10,00	72,00	22,00	30,00	0,15	3	HB
U12.026.083 Cx Z3 HB	5162857	●	12,00	12,00	83,00	26,00	36,00	0,18	3	HB
U14.026.083 Cx Z3 HB	5162860	●	14,00	14,00	83,00	26,00	36,00	0,21	3	HB
U16.032.092 Cx Z3 HB	5162861	●	16,00	16,00	92,00	32,00	42,00	0,24	3	HB

Bestellbeispiel Order example: 1 Stück piece 5162842 oder or U01.002.038 SH Z3 HA

Genauere Schnittwertempfehlung siehe Seite 206

Detailed cutting recommendations, see page 206

* Ausführung ohne Hals

* Version without neck

UNIttec extra long
 Extra Lange Ausführung Z3
 Execution extra long Z3

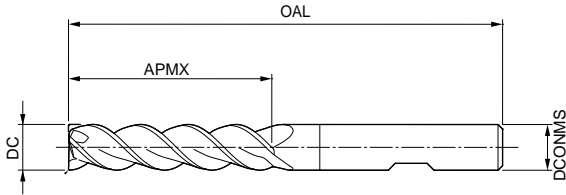

Hard Facts	
Fräserdurchmesser:	4,00 - 20,00 mm
Beschichtung:	TiAlN PVD
Schneidenzahl:	Z = 3
Drallwinkel:	45°
Diameter:	4.00 - 20.00 mm
Coating:	TiAlN PVD
Amount/Teeth:	Z = 3
Helix angle:	45°

UNIttec extra long		
ISO		
P	P.1	■
	P.2	■
	P.3	■
	P.4	■
	P.5	■
M	M.1	□
	M.2	□
K	K.1	■
	K.2	■
	K.3	□
N	N.1	□
	N.2	□
	N.3	□

Artikelbezeichnung Item Code	Bestell-Nr. Ordering No.	Verfügbarkeit Availability	Abmessungen [mm] Dimensions [mm]					ZEFF [☼]	Schaft Shank
			DC	DCONMS	OAL	APMX	Cx 45°		
UP04.019.063 Cx Z3 HB	5162864	●	4,00	6,00	63,00	19,00	0,06	3	HB
UP05.024.068 Cx Z3 HB	5162865	●	5,00	6,00	68,00	24,00	0,08	3	HB
UP06.024.068 Cx Z3 HB	5162866	●	6,00	6,00	68,00	24,00	0,09	3	HB
UP08.038.088 Cx Z3 HB	5162868	●	8,00	8,00	88,00	38,00	0,12	3	HB
UP10.045.095 Cx Z3 HB	5162869	●	10,00	10,00	95,00	45,00	0,15	3	HB
UP12.053.110 Cx Z3 HB	5162871	●	12,00	12,00	110,00	53,00	0,18	3	HB
UP16.063.123 Cx Z3 HB	5162872	●	16,00	16,00	123,00	63,00	0,24	3	HB
UP20.075.141 Cx Z3 HB	5162873	●	20,00	20,00	141,00	75,00	0,30	3	HB

Bestellbeispiel Order example: 1 Stück piece 5162864 oder or UP04.019.063 Cx Z3 HB
 Genaue Schnittwertempfehlung siehe Seite 206
 Detailed cutting recommendations, see page 206

- Verfügbar ab Lager Available from stock
- Kurzfristig lieferbar Available at short notice
- Lieferzeit auf Anfrage Delivery time on request

UNItec long

Lange Ausführung mit Hals Z4
Execution long neck Z4

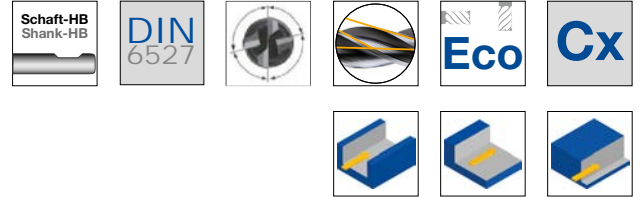
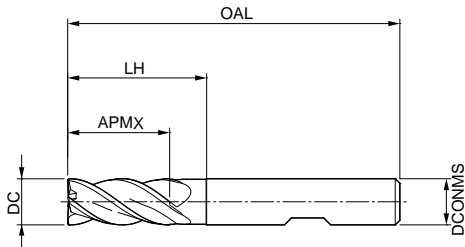

Hard Facts	
Fräserdurchmesser:	3,00 - 20,00 mm
Beschichtung:	AlCrN PVD
Schneidenzahl:	Z = 4
Drallwinkel:	36° - 38,5°
Besonderheiten:	Ungleichteilung
Diameter:	3.00 - 20.00 mm
Coating:	AlCrN PVD
Amount/Teeth:	Z = 4
Helix angle:	36° - 38,5°
Special feature:	Unequal division

UNItec long		
ISO		
P	P.1	■
	P.2	■
	P.3	■
	P.4	■
	P.5	■
M	M.1	■
	M.2	■
K	K.1	■
	K.2	■
	K.3	□

Artikelbezeichnung Item Code	Bestell-Nr. Ordering No.	Verfügbarkeit Availability	Abmessungen [mm] Dimensions [mm]						ZEFF [☆]	Schaft Shank
			DC	DCONMS	OAL	APMX	LH	Cx 45°		
U03.008.057 Cx Z4 HB	5162874	●	*3,00	6,00	57,00	8,00	-	0,06	4	HB
U04.011.057 Cx Z4 HB	5162878	●	*4,00	6,00	57,00	11,00	-	0,08	4	HB
U05.013.057 Cx Z4 HB	5162879	●	*5,00	6,00	57,00	13,00	-	0,10	4	HB
U06.013.057 Cx Z4 HB	5162880	●	6,00	6,00	57,00	13,00	20,00	0,12	4	HB
U08.021.063 Cx Z4 HB	5162881	●	8,00	8,00	63,00	21,00	25,00	0,16	4	HB
U10.022.072 Cx Z4 HB	5162882	●	10,00	10,00	72,00	22,00	30,00	0,20	4	HB
U12.026.083 Cx Z4 HB	5162883	●	12,00	12,00	83,00	26,00	36,00	0,24	4	HB
U14.026.083 Cx Z4 HB	5162884	●	14,00	14,00	83,00	26,00	36,00	0,28	4	HB
U16.036.092 Cx Z4 HB	5162886	●	16,00	16,00	92,00	36,00	42,00	0,32	4	HB
U18.036.092 Cx Z4 HB	5162890	●	18,00	18,00	92,00	36,00	42,00	0,36	4	HB
U20.041.104 Cx Z4 HB	5162893	●	20,00	20,00	104,00	41,00	53,00	0,40	4	HB

Bestellbeispiel Order example: 1 Stück piece 5162874 oder or U03.008.057 Cx Z4 HB
 Genaue Schnittwertempfehlung siehe Seite 206 * Ausführung ohne Hals
 Detailed cutting recommendations, see page 206 * Version without neck

UNItec Pro slot long neck

Lange Ausführung mit Hals Z3

Execution long neck Z3

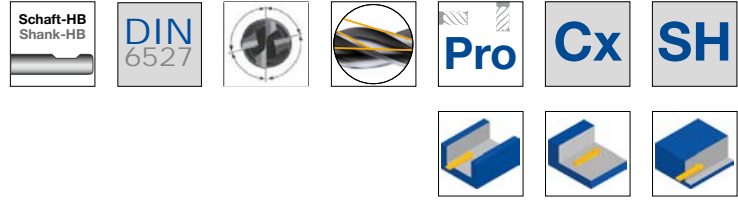
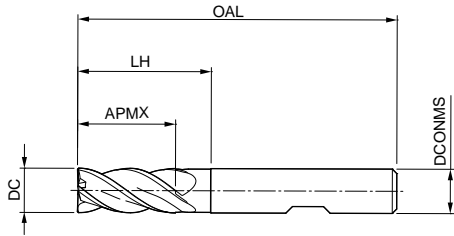

Hard Facts	
Fräserdurchmesser:	1,00 - 20,00 mm
Beschichtung:	AlCrN PVD
Schneidenzahl:	Z = 3
Drallwinkel:	42° - 43°
Besonderheiten:	Ungleichteilung
Diameter:	1.00 - 20.00 mm
Coating:	AlCrN PVD
Amount/Teeth:	Z = 3
Helix angle:	42° - 43°
Special feature:	Unequal division

UNItec Pro slot long neck		
ISO		
P	P.1	■
	P.2	■
	P.3	■
	P.4	■
	P.5	■
M	M.1	□
	M.2	□
K	K.1	■
	K.2	■
	K.3	■

Artikelbezeichnung Item Code	Bestell-Nr. Ordering No.	Verfügbarkeit Availability	Abmessungen [mm] Dimensions [mm]						ZEFF [⊙]	Schaft Shank
			DC	DCONMS	OAL	APMX	LH	Cx 45°		
UP01.003.054 SH Z3 HB	5163291	●	1,00	6,00	54,00	3,00	4,00	-	3	HB
UP01.5.004.054 SH Z3 HB	5163292	●	1,50	6,00	54,00	4,00	6,00	-	3	HB
UP02.005.054 SH Z3 HB	5163293	●	2,00	6,00	54,00	5,00	8,00	-	3	HB
UP02.5.007.054 SH Z3 HB	5163296	●	2,50	6,00	54,00	7,00	10,00	-	3	HB
UP03.008.057 Cx Z3 HB	5163299	●	3,00	6,00	57,00	8,00	12,50	0,06	3	HB
UP04.011.057 Cx Z3 HB	5163300	●	4,00	6,00	57,00	11,00	15,00	0,08	3	HB
UP05.013.057 Cx Z3 HB	5163301	●	5,00	6,00	57,00	13,00	16,00	0,10	3	HB
UP06.013.057 Cx Z3 HB	5163303	●	6,00	6,00	57,00	13,00	20,00	0,12	3	HB
UP08.021.063 Cx Z3 HB	5163304	●	8,00	8,00	63,00	21,00	27,00	0,16	3	HB
UP10.022.072 Cx Z3 HB	5163305	●	10,00	10,00	72,00	22,00	30,00	0,20	3	HB
UP12.026.083 Cx Z3 HB	5163306	●	12,00	12,00	83,00	26,00	36,00	0,24	3	HB
UP14.026.083 Cx Z3 HB	5163307	○	14,00	14,00	83,00	26,00	36,00	0,28	3	HB
UP16.036.092 Cx Z3 HB	5163308	●	16,00	16,00	92,00	36,00	44,00	0,32	3	HB
UP18.036.092 Cx Z3 HB	5163310	●	18,00	18,00	92,00	36,00	44,00	0,36	3	HB
UP20.041.104 Cx Z3 HB	5163311	●	20,00	20,00	104,00	41,00	55,00	0,40	3	HB

Bestellbeispiel Order example: 1 Stück piece 5163291 oder or UP01.003.054 SH Z3 HB
 Genaue Schnittwertempfehlung siehe Seite 208
 Detailed cutting recommendations, see page 208

- Verfügbar ab Lager Available from stock
- Kurzfristig lieferbar Available at short notice
- Lieferzeit auf Anfrage Delivery time on request

UNIttec Pro long neck

Lange Ausführung mit Hals Z4

Execution long neck Z4

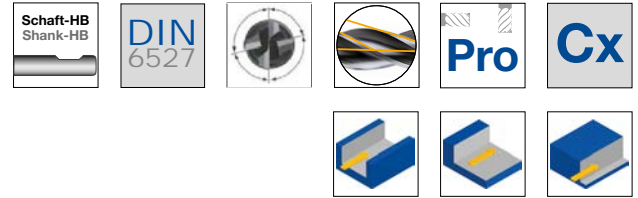
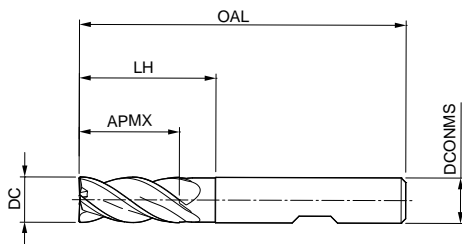

Hard Facts	
Fräserdurchmesser:	3,00 - 25,00 mm
Beschichtung:	AICrN PVD
Schneidenzahl:	Z = 4
Drallwinkel:	36°/38°
Besonderheiten:	Ungleichteilung
Diameter:	3.00 - 25.00 mm
Coating:	AICrN PVD
Amount/Teeth:	Z = 4
Helix angle:	36°/38°
Special feature:	Unequal division

UNIttec Pro long neck		
ISO		
P	P.1	■
	P.2	■
	P.3	■
	P.4	■
	P.5	■
M	M.1	■
	M.2	■
K	K.1	■
	K.2	■
	K.3	■

Artikelbezeichnung Item Code	Bestell-Nr. Ordering No.	Verfügbarkeit Availability	Abmessungen [mm] Dimensions [mm]						ZEFF [☆]	Schaft Shank
			DC	DCONMS	OAL	APMX	LH	Cx 45°		
UP03.008.057 Cx Z4 HB	5162959	●	3,00	6,00	57,00	8,00	9,50	0,06	4	HB
UP04.011.057 Cx Z4 HB	5162962	●	4,00	6,00	57,00	11,00	13,00	0,08	4	HB
UP05.013.057 Cx Z4 HB	5162964	●	5,00	6,00	57,00	13,00	15,50	0,10	4	HB
UP06.013.057 Cx Z4 HB	5162965	●	6,00	6,00	57,00	13,00	20,00	0,12	4	HB
UP07.016.063 Cx Z4 HB	5163148	○	7,00	8,00	63,00	16,00	25,00	0,14	4	HB
UP08.021.063 Cx Z4 HB	5162967	●	8,00	8,00	63,00	21,00	25,00	0,16	4	HB
UP09.022.072 Cx Z4 HB	5163150	○	9,00	10,00	72,00	22,00	30,00	0,18	4	HB
UP10.022.072 Cx Z4 HB	5162969	●	10,00	10,00	72,00	22,00	30,00	0,20	4	HB
UP12.026.083 Cx Z4 HB	5162971	●	12,00	12,00	83,00	26,00	36,00	0,24	4	HB
UP14.026.083 Cx Z4 HB	5163152	○	14,00	14,00	83,00	26,00	36,00	0,28	4	HB
UP16.036.092 Cx Z4 HB	5162972	●	16,00	16,00	92,00	36,00	42,00	0,32	4	HB
UP18.036.092 Cx Z4 HB	5163153	○	18,00	18,00	92,00	36,00	47,00	0,36	4	HB
UP20.041.104 Cx Z4 HB	5163154	○	20,00	20,00	104,00	41,00	55,00	0,40	4	HB
UP25.068.136 Cx Z4 HB	5163155	○	25,00	25,00	136,00	68,00	80,00	0,50	4	HB

Bestellbeispiel Order example: 1 Stück piece 5162959 oder or UP03.008.057 Cx Z4 HB

Genauere Schnittwertempfehlung siehe Seite 208
Detailed cutting recommendations, see page 208

* Untermaßgrößen speziell zum Passnutfräsen
* Undersize execution especially for keyway milling

UNItec Pro long neck FR

Lange Ausführung mit Hals und Eckenradius Z4

Execution long neck and full radius Z4

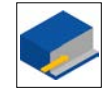
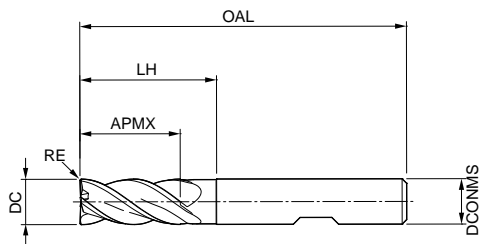

Hard Facts

Fräserdurchmesser: 4,00 - 20,00 mm
 Beschichtung: AlCrN PVD
 Schneidenzahl: Z = 4
 Drallwinkel: 36°/38°
 Besonderheiten: Ungleichteilung

Diameter: 4.00 - 20.00 mm
 Coating: AlCrN PVD
 Amount/Teeth: Z = 4
 Helix angle: 36°/38°
 Special feature: Unequal division

UNItec Pro long neck FR

ISO		
P	P.1	■
	P.2	■
	P.3	■
	P.4	■
	P.5	■
M	M.1	■
	M.2	■
K	K.1	■
	K.2	■
	K.3	■

Artikelbezeichnung Item Code	Bestell-Nr. Ordering No.	Verfügbarkeit Availability	Abmessungen [mm] Dimensions [mm]						ZEFF [☆]	Schaft Shank
			DC	DCONMS	OAL	APMX	LH	RE		
UP04.011.057 FR0.4 Z4 HB	5163157	●	4,00	6,00	57,00	11,00	13,00	0,40	4	HB
UP04.011.057 FR0.5 Z4 HB	5163159	●	4,00	6,00	57,00	11,00	13,00	0,50	4	HB
UP04.011.057 FR1.0 Z4 HB	5163161	●	4,00	6,00	57,00	11,00	13,00	1,00	4	HB
UP05.013.057 FR0.5 Z4 HB	5163162	●	5,00	6,00	57,00	13,00	15,50	0,50	4	HB
UP05.013.057 FR1.0 Z4 HB	5163167	●	5,00	6,00	57,00	13,00	15,50	1,00	4	HB
UP06.013.057 FR0.5 Z4 HB	5163170	●	6,00	6,00	57,00	13,00	20,00	0,50	4	HB
UP06.013.057 FR1.0 Z4 HB	5163172	●	6,00	6,00	57,00	13,00	20,00	1,00	4	HB
UP06.013.057 FR1.5 Z4 HB	5163174	●	6,00	6,00	57,00	13,00	20,00	1,50	4	HB
UP06.013.057 FR2.0 Z4 HB	5163175	●	6,00	6,00	57,00	13,00	20,00	2,00	4	HB
UP08.021.063 FR0.5 Z4 HB	5163176	●	8,00	8,00	63,00	21,00	25,00	0,50	4	HB
UP08.021.063 FR1.0 Z4 HB	5163179	●	8,00	8,00	63,00	21,00	25,00	1,00	4	HB
UP08.021.063 FR1.5 Z4 HB	5163185	●	8,00	8,00	63,00	21,00	25,00	1,50	4	HB
UP08.021.063 FR2.0 Z4 HB	5163196	●	8,00	8,00	63,00	21,00	25,00	2,00	4	HB
UP08.021.063 FR2.5 Z4 HB	5163198	●	8,00	8,00	63,00	21,00	25,00	2,50	4	HB
UP08.021.063 FR3.0 Z4 HB	5163199	●	8,00	8,00	63,00	21,00	25,00	3,00	4	HB

Bestellbeispiel Order example: 1 Stück piece 5163157 oder or UP04.011.057 FR0.4 Z4 HB

Genauere Schnittwertempfehlung siehe Seite 208

Detailed cutting recommendations, see page 208

- Verfügbar ab Lager Available from stock
- Kurzfristig lieferbar Available at short notice
- Lieferzeit auf Anfrage Delivery time on request

UNItec Pro long neck FR

Lange Ausführung mit Hals und Eckenradius Z4

Execution long neck and full radius Z4

Artikelbezeichnung Item Code	Bestell-Nr. Ordering No.	Verfügbarkeit Availability	Abmessungen [mm] Dimensions [mm]					ZEFF [☆]	Schaft Shank	
			DC	DCONMS	OAL	APMX	LH			RE
UP10.022.072 FR0.5 Z4 HB	5163201	○	10,00	10,00	72,00	22,00	30,00	0,50	4	HB
UP10.022.072 FR1.0 Z4 HB	5162767	○	10,00	10,00	72,00	22,00	30,00	1,00	4	HB
UP10.022.072 FR1.5 Z4 HB	5163204	○	10,00	10,00	72,00	22,00	30,00	1,50	4	HB
UP10.022.072 FR2.0 Z4 HB	5163207	○	10,00	10,00	72,00	22,00	30,00	2,00	4	HB
UP10.022.072 FR2.5 Z4 HB	5163208	○	10,00	10,00	72,00	22,00	30,00	2,50	4	HB
UP10.022.072 FR3.0 Z4 HB	5163211	○	10,00	10,00	72,00	22,00	30,00	3,00	4	HB
UP12.026.083 FR0.5 Z4 HB	5163212	○	12,00	12,00	83,00	26,00	36,00	0,50	4	HB
UP12.026.083 FR1.0 Z4 HB	5162768	○	12,00	12,00	83,00	26,00	36,00	1,00	4	HB
UP12.026.083 FR1.5 Z4 HB	5163214	○	12,00	12,00	83,00	26,00	36,00	1,50	4	HB
UP12.026.083 FR2.0 Z4 HB	5163227	○	12,00	12,00	83,00	26,00	36,00	2,00	4	HB
UP12.026.083 FR2.5 Z4 HB	5163228	○	12,00	12,00	83,00	26,00	36,00	2,50	4	HB
UP12.026.083 FR3.0 Z4 HB	5163229	○	12,00	12,00	83,00	26,00	36,00	3,00	4	HB
UP12.026.083 FR4.0 Z4 HB	5163230	○	12,00	12,00	83,00	26,00	36,00	4,00	4	HB
UP16.036.092 FR0.5 Z4 HB	5163231	○	16,00	16,00	92,00	36,00	42,00	0,50	4	HB
UP16.036.092 FR1.0 Z4 HB	5163232	○	16,00	16,00	92,00	36,00	42,00	1,00	4	HB
UP16.036.092 FR2.0 Z4 HB	5163233	○	16,00	16,00	92,00	36,00	42,00	2,00	4	HB
UP16.036.092 FR2.5 Z4 HB	5163234	○	16,00	16,00	92,00	36,00	42,00	2,50	4	HB
UP16.036.092 FR3.0 Z4 HB	5163236	○	16,00	16,00	92,00	36,00	42,00	3,00	4	HB
UP16.036.092 FR4.0 Z4 HB	5163237	○	16,00	16,00	92,00	36,00	42,00	4,00	4	HB
UP20.041.104 FR1.0 Z4 HB	5163240	○	20,00	20,00	104,00	41,00	52,00	1,00	4	HB
UP20.041.104 FR2.0 Z4 HB	5163243	○	20,00	20,00	104,00	41,00	52,00	2,00	4	HB
UP20.041.104 FR3.0 Z4 HB	5163245	○	20,00	20,00	104,00	41,00	52,00	3,00	4	HB
UP20.041.104 FR4.0 Z4 HB	5163247	○	20,00	20,00	104,00	41,00	52,00	4,00	4	HB

Bestellbeispiel Order example: 1 Stück piece 5163201 oder or UP10.022.072 FR0.5 Z4 HB

Genauere Schnittwertempfehlung siehe Seite 208

Detailed cutting recommendations, see page 208

UNItec Pro overlength neck

Überlange Ausführung mit Hals Z4

Execution overlength neck Z4

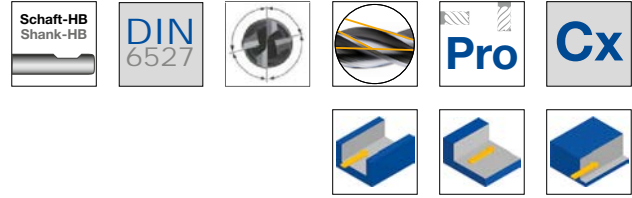
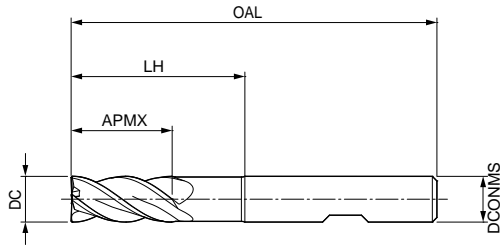

Hard Facts	
Fräserdurchmesser:	5,00 - 25,00 mm
Beschichtung:	AlCrN PVD
Schneidenzahl:	Z = 4
Achswinkel:	36°/38°
Besonderheiten:	Ungleichteilung
Diameter:	5.00 - 25.00 mm
Coating:	AlCrN PVD
Amount/Teeth:	Z = 4
Axis angle:	36°/38°
Special feature:	Unequal division

UNItec Pro overlength neck		
ISO		
P	P.1	■
	P.2	■
	P.3	■
	P.4	■
	P.5	■
M	M.1	■
	M.2	■
K	K.1	■
	K.2	■
	K.3	■

Artikelbezeichnung Item Code	Bestell-Nr. Ordering No.	Verfügbarkeit Availability	Abmessungen [mm] Dimensions [mm]						ZEFF [☆]	Schaft Shank
			DC	DCONMS	OAL	APMX	LH	Cx 45°		
UP05.013.062 Cx Z4 HB	5163248	●	5,00	6,00	62,00	13,00	24,00	0,10	4	HB
UP06.013.062 Cx Z4 HB	5163252	●	6,00	6,00	62,00	13,00	25,00	0,12	4	HB
UP08.021.068 Cx Z4 HB	5163256	●	8,00	8,00	68,00	21,00	30,00	0,16	4	HB
UP10.022.080 Cx Z4 HB	5163258	●	10,00	10,00	80,00	22,00	38,00	0,20	4	HB
UP12.026.093 Cx Z4 HB	5163259	●	12,00	12,00	93,00	26,00	46,00	0,24	4	HB
UP14.026.099 Cx Z4 HB	5163261	●	14,00	14,00	99,00	26,00	52,00	0,28	4	HB
UP16.036.108 Cx Z4 HB	5163263	●	16,00	16,00	108,00	36,00	58,00	0,32	4	HB
UP18.036.117 Cx Z4 HB	5163266	●	18,00	18,00	117,00	36,00	67,00	0,36	4	HB
UP20.041.126 Cx Z4 HB	5163268	●	20,00	20,00	126,00	41,00	74,00	0,40	4	HB
UP25.050.150 Cx Z4 HB	5163269	○	25,00	25,00	150,00	50,00	92,00	0,50	4	HB

Bestellbeispiel Order example: 1 Stück piece 5163248 oder or UP05.013.062 Cx Z4 HB

Genauere Schnittwertempfehlung siehe Seite 208

Detailed cutting recommendations, see page 208

- Verfügbar ab Lager Available from stock
- Kurzfristig lieferbar Available at short notice
- Lieferzeit auf Anfrage Delivery time on request

UNitec Pro extra long neck

Extra lange Ausführung mit Hals Z4

Execution extra long neck Z4

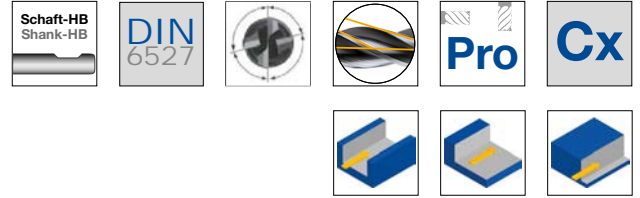
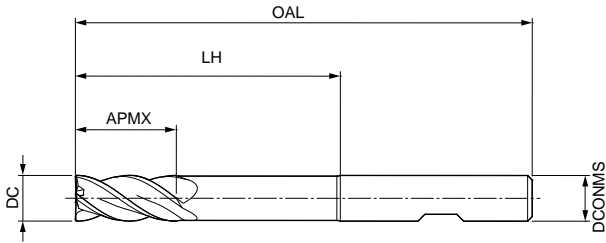

Hard Facts	
Fräserdurchmesser:	5,00 - 25,00 mm
Beschichtung:	AlCrN PVD
Schneidezahl:	Z = 4
Drallwinkel:	36°/38°
Besonderheiten:	Ungleichteilung
Diameter:	5.00 - 25.00 mm
Coating:	AlCrN PVD
Amount/Teeth:	Z = 4
Helix angle:	36°/38°
Special feature:	Unequal division

UNitec Pro extra long neck		
ISO		
P	P.1	■
	P.2	■
	P.3	■
	P.4	■
	P.5	■
M	M.1	■
	M.2	■
K	K.1	■
	K.2	■
	K.3	■

Artikelbezeichnung Item Code	Bestell-Nr. Ordering No.	Verfügbarkeit Availability	Abmessungen [mm] Dimensions [mm]						ZEFF [⊙]	Schaft Shank
			DC	DCONMS	OAL	APMX	LH	Cx 45°		
UP05.013.080 Cx Z4 HB	5163270	●	5,00	6,00	80,00	13,00	42,00	0,10	4	HB
UP06.013.080 Cx Z4 HB	5163272	●	6,00	6,00	80,00	13,00	42,00	0,12	4	HB
UP08.021.100 Cx Z4 HB	5163274	●	8,00	8,00	100,00	21,00	62,00	0,16	4	HB
UP10.022.100 Cx Z4 HB	5163276	●	10,00	10,00	100,00	22,00	58,00	0,20	4	HB
UP12.026.120 Cx Z4 HB	5163279	●	12,00	12,00	120,00	26,00	73,00	0,24	4	HB
UP14.026.120 Cx Z4 HB	5163280	●	14,00	14,00	120,00	26,00	73,00	0,28	4	HB
UP16.036.150 Cx Z4 HB	5163281	●	16,00	16,00	150,00	36,00	100,00	0,32	4	HB
UP18.036.150 Cx Z4 HB	5163282	○	18,00	18,00	150,00	36,00	100,00	0,36	4	HB
UP20.041.150 Cx Z4 HB	5163283	●	20,00	20,00	150,00	41,00	98,00	0,40	4	HB
UP25.050.175 Cx Z4 HB	5163286	○	25,00	25,00	175,00	50,00	117,00	0,50	4	HB

Bestellbeispiel Order example: 1 Stück piece 5163270 oder or UP05.013.080 Cx Z4 HB

Genauere Schnittwertempfehlung siehe Seite 208

Detailed cutting recommendations, see page 208

INotec Pro long neck

Lange Ausführung mit Hals Z4
Execution long neck Z4

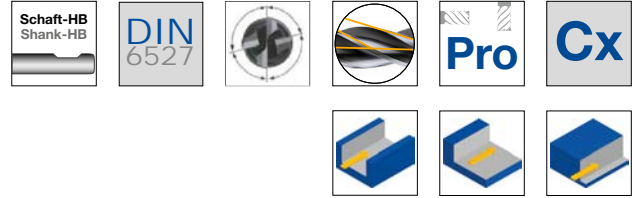
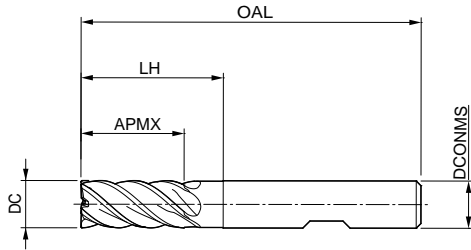

Hard Facts	
Fräserdurchmesser:	3,00 - 20,00 mm
Beschichtung:	TiAlN PVD
Schneidenzahl:	Z = 4
Drallwinkel:	38°
Besonderheiten:	Ungleichteilung
Diameter:	3.00 - 20.00 mm
Coating:	TiAlN PVD
Amount/Teeth:	Z = 4
Helix angle:	38°
Special feature:	Unequal division

UNiftec Pro long neck		
ISO		
M	M.1	■
	M.2	■

NEU

Artikelbezeichnung Item Code	Bestell-Nr. Ordering No.	Verfügbarkeit Availability	Abmessungen [mm] Dimensions [mm]					ZEFF [⊙]	Schaft Shank
			DC	DCONMS	OAL	APMX	Cx45°		
IP03.008.057 Cx Z4 HB	5206151	⊙	3,00	6,00	57,00	8,00	0,06	4	HB
IP04.011.057 Cx Z4 HB	5206152	⊙	4,00	6,00	57,00	11,00	0,08	4	HB
IP05.013.057 Cx Z4 HB	5206153	⊙	5,00	6,00	57,00	13,00	0,10	4	HB
IP06.013.057 Cx Z4 HB	5206154	⊙	6,00	6,00	57,00	13,00	0,12	4	HB
IP08.019.063 Cx Z4 HB	5206155	⊙	8,00	8,00	63,00	19,00	0,16	4	HB
IP10.022.072 Cx Z4 HB	5206158	⊙	10,00	10,00	72,00	22,00	0,20	4	HB
IP12.026.083 Cx Z4 HB	5206159	⊙	12,00	12,00	83,00	26,00	0,24	4	HB
IP14.026.083 Cx Z4 HB	5206161	○	14,00	14,00	83,00	26,00	0,28	4	HB
IP16.032.092 Cx Z4 HB	5206162	⊙	16,00	16,00	92,00	32,00	0,32	4	HB
IP18.032.092 Cx Z4 HB	5206163	○	18,00	18,00	92,00	32,00	0,36	4	HB
IP20.038.104 Cx Z4 HB	5206164	⊙	20,00	20,00	104,00	38,00	0,40	4	HB

Bestellbeispiel Order example: 1 Stück piece 5206151 oder or IP03.008.057 Cx Z4 HB
Genaue Schnittwertempfehlung siehe Seite 210
Detailed cutting recommendations, see page 210

- Verfügbar ab Lager Available from stock
- ⊙ Kurzfristig lieferbar Available at short notice
- Lieferzeit auf Anfrage Delivery time on request

Tltec Pro long neck

Lange Ausführung mit Hals Z4

Execution long neck Z4

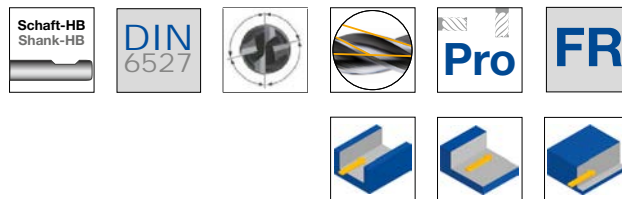
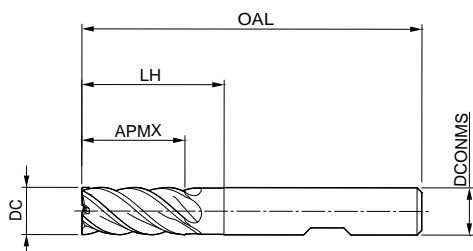

Hard Facts

Fräserdurchmesser: 6,00 - 25,00 mm
 Beschichtung: AlCrN PVD
 Schneidenzahl: Z = 4
 Drallwinkel: 43°
 Besonderheiten: Ungleichteilung

Diameter: 6.00 - 25.00 mm
 Coating: AlCrN PVD
 Amount/Teeth: Z = 4
 Helix angle: 43°
 Special feature: Unequal division

UNltec Pro long neck

ISO		
P	S.1	■
	S.2	■

NEU

Artikelbezeichnung Item Code	Bestell-Nr. Ordering No.	Verfügbarkeit Availability	Abmessungen [mm] Dimensions [mm]						ZEFF [☆]	Schaft Shank
			DC	DCONMS	OAL	APMX	LH	Cx 45°		
TIP06.013.057 FR0.5 Z4 HB	5206166	●	6,00	6,00	57,00	13,00	20,00	0,50	4	HB
TIP06.013.057 FR1.0 Z4 HB	5206169	●	6,00	6,00	57,00	13,00	20,00	1,00	4	HB
TIP08.021.063 FR0.5 Z4 HB	5206170	●	8,00	6,00	63,00	21,00	25,00	0,50	4	HB
TIP08.021.063 FR1.0 Z4 HB	5206171	●	8,00	6,00	63,00	21,00	25,00	1,00	4	HB
TIP08.021.063 FR2.0 Z4 HB	5206173	○	8,00	8,00	63,00	21,00	25,00	2,00	4	HB
TIP10.022.072 FR0.5 Z4 HB	5206174	●	10,00	10,00	72,00	22,00	30,00	0,50	4	HB
TIP10.022.072 FR1.0 Z4 HB	5206175	●	10,00	10,00	72,00	22,00	30,00	1,00	4	HB
TIP10.022.072 FR2.0 Z4 HB	5206176	○	10,00	10,00	72,00	22,00	30,00	2,00	4	HB
TIP12.026.083 FR0.5 Z4 HB	5206177	●	12,00	12,00	83,00	26,00	36,00	0,50	4	HB
TIP12.026.083 FR1.0 Z4 HB	5206178	●	12,00	12,00	83,00	26,00	36,00	1,00	4	HB
TIP12.026.083 FR2.0 Z4 HB	5206180	○	12,00	12,00	83,00	26,00	36,00	2,00	4	HB
TIP12.026.083 FR3.0 Z4 HB	5206183	○	12,00	12,00	83,00	26,00	36,00	3,00	4	HB
TIP16.036.092 FR1.0 Z4 HB	5206188	●	16,00	16,00	92,00	36,00	42,00	1,00	4	HB
TIP16.036.092 FR2.0 Z4 HB	5206190	●	16,00	16,00	92,00	36,00	42,00	2,00	4	HB
TIP16.036.092 FR3.0 Z4 HB	5206223	○	16,00	16,00	92,00	36,00	42,00	3,00	4	HB
TIP16.036.092 FR4.0 Z4 HB	5206224	○	16,00	16,00	92,00	36,00	42,00	4,00	4	HB
TIP20.041.104 FR1.0 Z4 HB	5206225	●	20,00	20,00	104,00	41,00	55,00	1,00	4	HB
TIP20.041.104 FR2.0 Z4 HB	5206226	●	20,00	20,00	104,00	41,00	55,00	2,00	4	HB
TIP20.041.104 FR3.0 Z4 HB	5206227	○	20,00	20,00	104,00	41,00	55,00	3,00	4	HB
TIP20.041.104 FR4.0 Z4 HB	5206228	○	20,00	20,00	104,00	41,00	55,00	4,00	4	HB
TIP25.050.136 FR2.0 Z4 HB	5206229	●	25,00	25,00	136,00	50,00	65,00	2,00	4	HB
TIP25.050.136 FR3.0 Z4 HB	5206230	○	25,00	25,00	136,00	50,00	65,00	3,00	4	HB
TIP25.050.136 FR4.0 Z4 HB	5206231	○	25,00	25,00	136,00	50,00	65,00	4,00	4	HB

Bestellbeispiel Order example: 1 Stück piece 5206166 oder or TIP06.013.057 FR0.5 Z4 HB

Genauere Schnittwertempfehlung siehe Seite 210

Detailed cutting recommendations, see page 210

UNItec Pro Silence long neck

Lange Ausführung mit Hals Z5

Execution long neck Z5

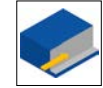
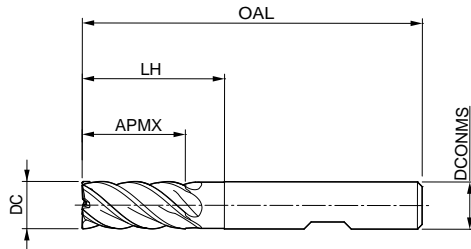

Hard Facts	
Fräserdurchmesser:	4,00 - 25,00 mm
Beschichtung:	AlCrN PVD
Schneidenzahl:	Z = 5
Drallwinkel:	41° - 42°
Besonderheiten:	Ungleichteilung
Diameter:	4.00 - 25.00 mm
Coating:	AlCrN PVD
Amount/Teeth:	Z = 5
Helix angle:	41° - 42°
Special feature:	Unequal division

UNItec Pro Silence long neck		
ISO		
P	P.1	■
	P.2	■
	P.3	■
	P.4	■
	P.5	■
M	M.1	■
	M.2	■
K	K.1	■
	K.2	■
	K.3	■

Artikelbezeichnung Item Code	Bestell-Nr. Ordering No.	Verfügbarkeit Availability	Abmessungen [mm] Dimensions [mm]						ZEFF [☆]	Schaft Shank
			DC	DCONMS	OAL	APMX	LH	Cx 45°		
UP04.011.057 Cx Z5 HB	5163312	●	4,00	6,00	57,00	11,00	13,00	0,08	5	HB
UP05.013.057 Cx Z5 HB	5163314	●	5,00	6,00	57,00	13,00	15,50	0,10	5	HB
UP06.013.057 Cx Z5 HB	5163317	●	6,00	6,00	57,00	13,00	19,00	0,12	5	HB
UP08.019.063 Cx Z5 HB	5163318	●	8,00	8,00	63,00	19,00	25,00	0,16	5	HB
UP10.022.072 Cx Z5 HB	5163320	●	10,00	10,00	72,00	22,00	30,00	0,20	5	HB
UP12.026.083 Cx Z5 HB	5163323	●	12,00	12,00	83,00	26,00	36,00	0,24	5	HB
UP14.026.083 Cx Z5 HB	5163325	○	14,00	14,00	83,00	26,00	36,00	0,28	5	HB
UP16.032.092 Cx Z5 HB	5163327	●	16,00	16,00	92,00	32,00	42,00	0,32	5	HB
UP18.032.092 Cx Z5 HB	5163329	●	18,00	18,00	92,00	32,00	42,00	0,36	5	HB
UP20.041.104 Cx Z5 HB	5163331	●	20,00	20,00	104,00	41,00	52,00	0,40	5	HB
UP25.050.125 Cx Z5 HB	5163332	●	25,00	25,00	125,00	50,00	65,00	0,50	5	HB

Bestellbeispiel Order example: 1 Stück piece 5163312 oder or UP04.011.057 Cx Z5 HB

Genaue Schnitwertempfehlung siehe Seite 210

Detailed cutting recommendations, see page 210

● Verfügbar ab Lager Available from stock

○ Kurzfristig lieferbar Available at short notice

○ Lieferzeit auf Anfrage Delivery time on request

MULTitec Universal short

Kurze Ausführung Z3

Execution short Z3

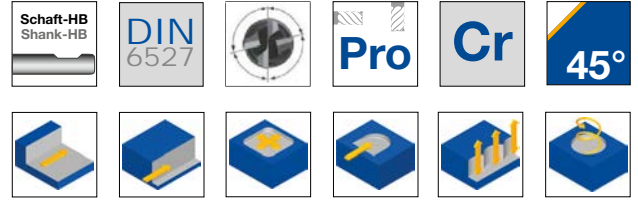
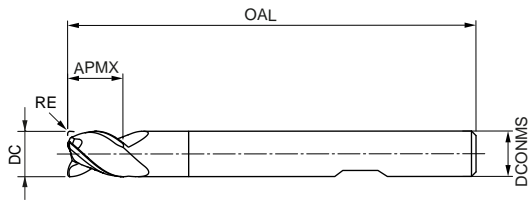

Hard Facts	
Fräserdurchmesser:	3,80 - 20,00 mm
Beschichtung:	AlCrN PVD
Schneidenzahl:	Z = 3
Drallwinkel:	42°
Besonderheiten:	Ungleichteilung, spezielle Stirngeometrie zum Schrägen eintauchen bis max. 45°, Ideal für helikales Eintauchen und Tauchfräsen
Diameter:	3.80 - 20.00 mm
Coating:	AlCrN PVD
Amount/Teeth:	Z = 3
Helix angle:	42°
Special feature:	Unequal division, special geometrical design for ramping in up to max. ramping angled 45°, excellent for helical ramping in and ramp milling

MULTitec Universal short		
ISO		
P	P.1	■
	P.2	■
	P.3	■
	P.4	■
	P.5	■
M	M.1	■
	M.2	■
K	K.1	■
	K.2	■
	K.3	■

Artikelbezeichnung Item Code	Bestell-Nr. Ordering No.	Verfügbarkeit Availability	Abmessungen [mm] Dimensions [mm]					ZEFF [⊙]	Schaft Shank
			DC	DCONMS	OAL	APMX	RE		
MU03.8.005.054 Cr Z3 HB	5163555	●	3,80	6,00	54,00	5,00	0,12	3	HB
MU04.005.054 Cr Z3 HB	5163556	●	4,00	6,00	54,00	5,00	0,12	3	HB
MU04.8.006.054 Cr Z3 HB	5163557	●	4,80	6,00	54,00	6,00	0,20	3	HB
MU05.006.054 Cr Z3 HB	5163558	●	5,00	6,00	54,00	6,00	0,20	3	HB
MU05.7.007.054 Cr Z3 HB	5163559	●	5,70	6,00	54,00	7,00	0,20	3	HB
MU06.007.054 Cr Z3 HB	5163560	●	6,00	6,00	54,00	7,00	0,20	3	HB
MU06.7.008.058 Cr Z3 HB	5163562	○	6,70	8,00	58,00	8,00	0,20	3	HB
MU07.008.058 Cr Z3 HB	5163563	●	7,00	8,00	58,00	8,00	0,20	3	HB
MU07.7.009.058 Cr Z3 HB	5163564	●	7,70	8,00	58,00	9,00	0,20	3	HB
MU08.009.058 Cr Z3 HB	5163566	●	8,00	8,00	58,00	9,00	0,20	3	HB
MU08.7.010.066 Cr Z3 HB	5163567	●	8,70	10,00	66,00	10,00	0,32	3	HB
MU09.010.066 Cr Z3 HB	5163571	●	9,00	10,00	66,00	10,00	0,32	3	HB
MU09.7.011.066 Cr Z3 HB	5163575	●	9,70	10,00	66,00	11,00	0,32	3	HB
MU10.011.066 Cr Z3 HB	5163576	●	10,00	10,00	66,00	11,00	0,32	3	HB
MU11.7.012.073 Cr Z3 HB	5163577	●	11,70	12,00	73,00	12,00	0,32	3	HB
MU12.012.073 Cr Z3 HB	5163578	●	12,00	12,00	73,00	12,00	0,32	3	HB
MU13.7.014.075 Cr Z3 HB	5163579	○	13,70	14,00	75,00	14,00	0,32	3	HB
MU14.014.075 Cr Z3 HB	5163580	●	14,00	14,00	75,00	14,00	0,32	3	HB
MU15.5.016.082 Cr Z3 HB	5163582	●	15,50	16,00	82,00	16,00	0,32	3	HB
MU16.016.082 Cr Z3 HB	5163583	●	16,00	16,00	82,00	16,00	0,32	3	HB
MU17.5.018.084 Cr Z3 HB	5163585	○	17,50	18,00	84,00	18,00	0,32	3	HB
MU18.018.084 Cr Z3 HB	5163586	○	18,00	18,00	84,00	18,00	0,32	3	HB
MU19.5.020.092 Cr Z3 HB	5163588	○	19,50	20,00	92,00	20,00	0,50	3	HB
MU20.020.092 Cr Z3 HB	5163589	●	20,00	20,00	92,00	20,00	0,50	3	HB

Bestellbeispiel Order example: 1 Stück piece 5163555 oder or MU03.8.005.054 Cr Z3 HB

Genauere Schnittwertempfehlung siehe Seite 210

Detailed cutting recommendations, see page 210

MULTitec Universal long neck

Lange Ausführung mit Hals Z3

Execution long neck Z3

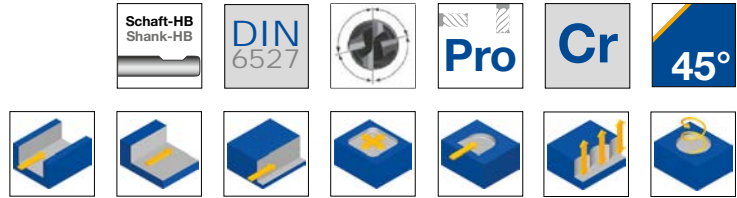
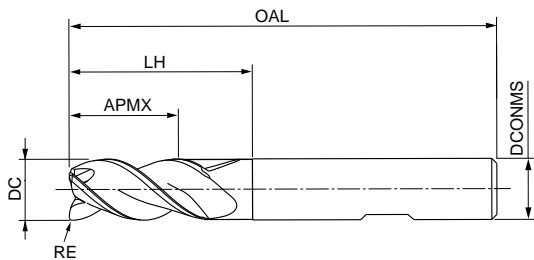

Hard Facts	
Fräserdurchmesser:	4,00 - 20,00 mm
Beschichtung:	AlCrN PVD
Schneidenzahl:	Z = 3
Drallwinkel:	42°
Besonderheiten:	Ungleichteilung, spezielle Stirngeometrie zum Schrägen eintauchen bis max. 45°, Ideal für helikales Eintauchen und Tauchfräsen
Diameter:	3.80 - 20.00 mm
Coating:	AlCrN PVD
Amount/Teeth:	Z = 3
Helix angle:	42°
Special feature:	Unequal division, special geometrical design for ramping in up to max. ramping angled 45°, excellent for helical ramping in and ramp milling

MULTitec Universal long neck		
ISO		
P	P.1	■
	P.2	■
	P.3	■
	P.4	■
	P.5	■
M	M.1	■
	M.2	■
K	K.1	■
	K.2	■
	K.3	■

Artikelbezeichnung Item Code	Bestell-Nr. Ordering No.	Verfügbarkeit Availability	Abmessungen [mm] Dimensions [mm]						ZEFF ^o	Schaft Shank
			DC	DCONMS	OAL	APMX	LH	RE		
MU04.011.057 Cr Z3 HB	5163032	●	4,00	6,00	57,00	11,00	13,00	0,20	3	HB
MU04.8.011.057 Cr Z3 HB	5163592	○	4,80	6,00	57,00	11,00	15,50	0,24	3	HB
MU05.013.057 Cr Z3 HB	5163033	●	5,00	6,00	57,00	13,00	15,50	0,25	3	HB
MU05.7.013.057 Cr Z3 HB	5163595	○	5,70	6,00	57,00	13,00	19,00	0,29	3	HB
MU06.013.057 Cr Z3 HB	5163034	●	6,00	6,00	57,00	13,00	19,00	0,30	3	HB
MU06.7.016.063 Cr Z3 HB	5163596	○	6,70	8,00	63,00	16,00	25,00	0,34	3	HB
MU07.016.063 Cr Z3 HB	5163597	○	7,00	8,00	63,00	16,00	25,00	0,35	3	HB
MU07.7.019.063 Cr Z3 HB	5163599	○	7,70	8,00	63,00	19,00	25,00	0,39	3	HB
MU08.019.063 Cr Z3 HB	5163035	●	8,00	8,00	63,00	19,00	25,00	0,40	3	HB
MU08.7.022.072 Cr Z3 HB	5163603	○	8,70	10,00	72,00	22,00	30,00	0,44	3	HB
MU09.022.072 Cr Z3 HB	5163604	○	9,00	10,00	72,00	22,00	30,00	0,45	3	HB
MU09.7.022.072 Cr Z3 HB	5163605	○	9,70	10,00	72,00	22,00	30,00	0,49	3	HB
MU10.022.072 Cr Z3 HB	5163036	●	10,00	10,00	72,00	22,00	30,00	0,50	3	HB
MU11.7.026.083 Cr Z3 HB	5163609	○	11,70	12,00	83,00	26,00	36,00	0,59	3	HB
MU12.026.083 Cr Z3 HB	5163037	●	12,00	12,00	83,00	26,00	36,00	0,60	3	HB
MU13.7.026.083 Cr Z3 HB	5163610	○	13,70	14,00	83,00	26,00	36,00	0,69	3	HB
MU14.026.083 Cr Z3 HB	5163611	○	14,00	14,00	83,00	26,00	36,00	0,70	3	HB
MU15.5.031.092 Cr Z3 HB	5163612	○	15,50	16,00	92,00	31,00	42,00	0,78	3	HB
MU16.031.092 Cr Z3 HB	5163039	●	16,00	16,00	92,00	31,00	42,00	0,80	3	HB
MU17.5.031.092 Cr Z3 HB	5163613	○	17,50	18,00	92,00	31,00	42,00	0,88	3	HB
MU18.031.092 Cr Z3 HB	5163614	○	18,00	18,00	92,00	31,00	42,00	0,90	3	HB
MU19.5.041.104 Cr Z3 HB	5163615	○	19,50	20,00	104,00	41,00	52,00	0,98	3	HB
MU20.041.104 Cr Z3 HB	5163618	○	20,00	20,00	104,00	41,00	52,00	1,00	3	HB

Bestellbeispiel Order example: 1 Stück piece 5163032 oder or MU04.011.057 Cr Z3 HB

Genauere Schnittwertempfehlung siehe Seite 210

Detailed cutting recommendations, see page 210

● Verfügbar ab Lager Available from stock

○ Kurzfristig lieferbar Available at short notice

○ Lieferzeit auf Anfrage Delivery time on request

MULTItec Universal overlength neck

Überlange Ausführung mit Hals Z3

Execution overlength neck Z3

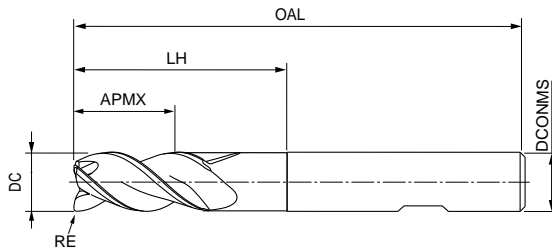

Hard Facts	
Fräserdurchmesser:	5,00 - 20,00 mm
Beschichtung:	AlCrN PVD
Schneidezah:	Z = 3
Drallwinkel:	42°
Besonderheiten:	Ungleichteilung, spezielle Stirngeometrie zum Schrägen eintauchen bis max. 45°, Ideal für helikales Eintauchen und Tauchfräsen
Diameter:	5.00 - 20.00 mm
Coating:	AlCrN PVD
Amount/Teeth:	Z = 3
Helix angle:	42°
Special feature:	Unequal division, special geometrical design for ramping in up to max. ramping angled 45°, excellent for helical ramping in and ramp milling

MULTItec Universal overlength neck		
ISO		
P	P.1	■
	P.2	■
	P.3	■
	P.4	■
	P.5	■
M	M.1	■
	M.2	■
K	K.1	■
	K.2	■
	K.3	■

Artikelbezeichnung Item Code	Bestell-Nr. Ordering No.	Verfügbarkeit Availability	Abmessungen [mm] Dimensions [mm]						ZEFF [◇]	Schaft Shank
			DC	DCONMS	OAL	APMX	LH	RE		
MU05.013.062 Cr Z3 HB	5163621	○	5,00	6,00	62,00	13,00	24,00	0,25	3	HB
MU05.7.013.062 Cr Z3 HB	5163634	●	5,70	6,00	62,00	13,00	24,00	0,29	3	HB
MU06.013.062 Cr Z3 HB	5163636	●	6,00	6,00	62,00	13,00	24,00	0,30	3	HB
MU06.7.016.068 Cr Z3 HB	5163637	●	6,70	8,00	68,00	16,00	30,00	0,34	3	HB
MU07.016.068 Cr Z3 HB	5163638	●	7,00	8,00	68,00	16,00	30,00	0,35	3	HB
MU07.7.021.068 Cr Z3 HB	5163639	●	7,70	8,00	68,00	21,00	30,00	0,39	3	HB
MU08.021.068 Cr Z3 HB	5163641	●	8,00	8,00	68,00	21,00	30,00	0,40	3	HB
MU08.7.022.080 Cr Z3 HB	5163642	●	8,70	10,00	80,00	22,00	38,00	0,44	3	HB
MU09.022.080 Cr Z3 HB	5163643	●	9,00	10,00	80,00	22,00	38,00	0,45	3	HB
MU09.7.022.080 Cr Z3 HB	5163644	●	9,70	10,00	80,00	22,00	38,00	0,49	3	HB
MU10.022.080 Cr Z3 HB	5163646	●	10,00	10,00	80,00	22,00	38,00	0,50	3	HB
MU11.7.026.093 Cr Z3 HB	5163648	●	11,70	12,00	93,00	26,00	46,00	0,59	3	HB
MU12.026.093 Cr Z3 HB	5163655	●	12,00	12,00	93,00	26,00	46,00	0,60	3	HB
MU13.7.026.099 Cr Z3 HB	5163658	●	13,70	14,00	99,00	26,00	52,00	0,69	3	HB
MU14.026.099 Cr Z3 HB	5163659	●	14,00	14,00	99,00	26,00	52,00	0,70	3	HB
MU15.5.036.108 Cr Z3 HB	5163660	●	15,50	16,00	108,00	36,00	58,00	0,78	3	HB
MU16.036.108 Cr Z3 HB	5163661	●	16,00	16,00	108,00	36,00	58,00	0,80	3	HB
MU17.5.036.117 Cr Z3 HB	5163662	●	17,50	18,00	117,00	36,00	67,00	0,88	3	HB
MU18.036.117 Cr Z3 HB	5163663	●	18,00	18,00	117,00	36,00	67,00	0,90	3	HB
MU19.5.041.126 Cr Z3 HB	5163664	●	19,50	20,00	126,00	41,00	74,00	0,98	3	HB
MU20.041.126 Cr Z3 HB	5163665	●	20,00	20,00	126,00	41,00	74,00	1,00	3	HB

Bestellbeispiel Order example: 1 Stück piece 5163621 oder or MU05.013.062 Cr Z3 HB

Genauere Schnittwertempfehlung siehe Seite 210

Detailed cutting recommendations, see page 210

MULTitec N long neck

Lange Ausführung mit Hals Z3
Execution long neck Z3

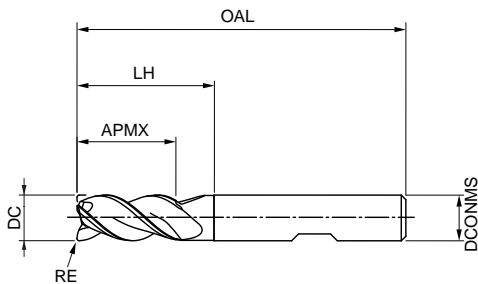

Hard Facts	
Fräserdurchmesser:	5,00 - 20,00 mm
Beschichtung:	Ti+C PVD
Schneidenzahl:	Z = 3
Drallwinkel:	42°
Besonderheiten:	Ungleichteilung, spezielle Stirngeometrie zum Schrägen eintauchen bis max. 45°, Ideal für helikales Eintauchen und Tauchfräsen
Diameter:	5.00 - 20.00 mm
Coating:	Ti+C PVD
Amount/Teeth:	Z = 3
Helix angle:	42°
Special feature:	Unequal division, special geometrical design for ramping in up to max. ramping angled 45°, excellent for helical ramping in and ramp milling

MULTitec N long neck		
ISO		
N	N.1	■
	N.2	■
	N.3	■
	N.4	□

Artikelbezeichnung Item Code	Bestell-Nr. Ordering No.	Verfügbarkeit Availability	Abmessungen [mm] Dimensions [mm]						ZEFF [☆]	Schaft Shank
			DC	DCONMS	OAL	APMX	LH	RE		
MUN05.013.057 Cr Z3 HB	5163044	●	5,00	6,00	57,00	13,00	15,50	0,20	3	HB
MUN05.7.013.057 Cr Z3 HB	5163672	○	5,70	6,00	57,00	13,00	19,00	0,20	3	HB
MUN06.013.057 Cr Z3 HB	5163047	●	6,00	6,00	57,00	13,00	19,00	0,20	3	HB
MUN06.7.016.063 Cr Z3 HB	5163674	○	6,70	8,00	63,00	16,00	25,00	0,20	3	HB
MUN07.016.063 Cr Z3 HB	5163675	○	7,00	8,00	63,00	16,00	25,00	0,20	3	HB
MUN07.7.016.063 Cr Z3 HB	5163676	○	7,70	8,00	63,00	16,00	25,00	0,20	3	HB
MUN08.019.063 Cr Z3 HB	5163048	●	8,00	8,00	63,00	19,00	25,00	0,20	3	HB
MUN08.7.022.072 Cr Z3 HB	5163677	○	8,70	10,00	72,00	22,00	30,00	0,32	3	HB
MUN09.022.072 Cr Z3 HB	5163678	○	9,00	10,00	72,00	22,00	30,00	0,32	3	HB
MUN09.7.022.072 Cr Z3 HB	5163681	○	9,70	10,00	72,00	22,00	30,00	0,32	3	HB
MUN10.022.072 Cr Z3 HB	5163053	●	10,00	10,00	72,00	22,00	30,00	0,32	3	HB
MUN11.7.026.083 Cr Z3 HB	5163683	○	11,70	12,00	83,00	26,00	36,00	0,32	3	HB
MUN12.026.083 Cr Z3 HB	5163054	●	12,00	12,00	83,00	26,00	36,00	0,32	3	HB
MUN13.7.026.083 Cr Z3 HB	5163684	○	13,70	14,00	83,00	26,00	36,00	0,32	3	HB
MUN14.026.083 Cr Z3 HB	5163685	○	14,00	14,00	83,00	26,00	36,00	0,32	3	HB
MUN15.5.031.092 Cr Z3 HB	5163686	○	15,50	16,00	92,00	31,00	42,00	0,32	3	HB
MUN16.031.092 Cr Z3 HB	5163061	●	16,00	16,00	92,00	31,00	42,00	0,32	3	HB
MUN17.5.031.092 Cr Z3 HB	5163687	○	17,50	18,00	92,00	31,00	42,00	0,32	3	HB
MUN18.031.092 Cr Z3 HB	5163688	○	18,00	18,00	92,00	31,00	42,00	0,32	3	HB
MUN19.5.041.104 Cr Z3 HB	5163689	○	19,50	20,00	104,00	41,00	52,00	0,50	3	HB
MUN20.041.104 Cr Z3 HB	5163692	●	20,00	20,00	104,00	41,00	52,00	0,50	3	HB

Bestellbeispiel Order example: 1 Stück piece 5163044 oder or MUN05.013.057 Cr Z3 HB
 Genaue Schnittwertempfehlung siehe Seite 212
 Detailed cutting recommendations, see page 212

- Verfügbar ab Lager Available from stock
- Kurzfristig lieferbar Available at short notice
- Lieferzeit auf Anfrage Delivery time on request

UNitec N long

Lange Ausführung Z2

Execution long Z2

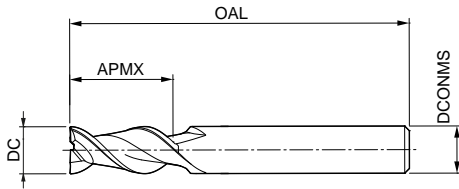

Hard Facts	
Fräserdurchmesser:	2,00 - 20,00 mm
Beschichtung:	unbeschichtet
Schneidenzahl:	Z = 2
Drallwinkel:	45°
Diameter:	2.00 - 20.00 mm
Coating:	uncoated
Amount/Teeth:	Z = 2
Helix angle:	45°

UNitec N long		
ISO		
N	N.1	■
	N.2	■
	N.3	■
	N.4	□

Artikelbezeichnung Item Code	Bestell-Nr. Ordering No.	Verfügbarkeit Availability	Abmessungen [mm] Dimensions [mm]					ZEFF	Schaft Shank
			DC	DCONMS	OAL	APMX	Cx 45°		
UN02.006.057 Cx Z2 HA	5162916	🕒	2,00	6,00	57,00	6,00	0,03	2	HA
UN03.007.057 Cx Z2 HA	5162918	🕒	3,00	6,00	57,00	7,00	0,05	2	HA
UN04.008.057 Cx Z2 HA	5162919	🕒	4,00	6,00	57,00	8,00	0,06	2	HA
UN05.010.057 Cx Z2 HA	5162925	🕒	5,00	6,00	57,00	10,00	0,08	2	HA
UN06.010.057 Cx Z2 HA	5162926	🕒	6,00	6,00	57,00	10,00	0,09	2	HA
UN08.016.063 Cx Z2 HA	5162928	🕒	8,00	8,00	63,00	16,00	0,12	2	HA
UN10.019.072 Cx Z2 HA	5162929	🕒	10,00	10,00	72,00	19,00	0,15	2	HA
UN12.022.083 Cx Z2 HA	5162930	🕒	12,00	12,00	83,00	22,00	0,18	2	HA
UN16.026.092 Cx Z2 HA	5162933	🕒	16,00	16,00	92,00	26,00	0,24	2	HA
UN20.032.104 Cx Z2 HA	5162934	🕒	20,00	20,00	104,00	32,00	0,30	2	HA

Bestellbeispiel Order example: 1 Stück piece 5162916 oder or UN02.006.057 Cx Z2 HA
 Genaue Schnittwertempfehlung siehe Seite 212
 Detailed cutting recommendations, see page 212

UNItec Pro N long neck

Lange Ausführung mit Hals Z3

Execution long neck Z3

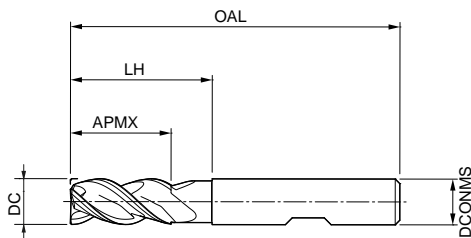

Hard Facts	
Fräserdurchmesser:	3,00 - 20,00 mm
Beschichtung:	unbeschichtet
Schneidenzahl:	Z = 3
Drallwinkel:	42° - 43°
Besonderheiten:	Ungleichteilung, Nuten poliert
Diameter:	3.00 - 20.00 mm
Coating:	uncoated
Amount/Teeth:	Z = 3
Helix angle:	42° - 43°
Special feature:	unequal devison, polished

UNItec Pro N long neck		
ISO		
N	N.1	■
	N.2	■
	N.3	■
	N.4	□

Artikelbezeichnung Item Code	Bestell-Nr. Ordering No.	Verfügbarkeit Availability	Abmessungen [mm] Dimensions [mm]						ZEFF [⊙]	Schaft Shank
			DC	DCONMS	OAL	APMX	LH	Cx 45°		
UPN03.007.057 Cx Z3 HB	5163004	●	*3,00	6,00	57,00	7,00	-	0,06	3	HB
UPN04.008.057 Cx Z3 HB	5163005	●	*4,00	6,00	57,00	8,00	-	0,08	3	HB
UPN05.010.057 Cx Z3 HB	5163009	●	*5,00	6,00	57,00	10,00	-	0,10	3	HB
UPN06.010.057 Cx Z3 HB	5163011	●	6,00	6,00	57,00	10,00	18,00	0,12	3	HB
UPN08.016.063 Cx Z3 HB	5163014	●	8,00	8,00	63,00	16,00	25,00	0,16	3	HB
UPN10.019.072 Cx Z3 HB	5163024	●	10,00	10,00	72,00	19,00	30,00	0,20	3	HB
UPN12.022.083 Cx Z3 HB	5163029	●	12,00	12,00	83,00	22,00	36,00	0,24	3	HB
UPN14.022.083 Cx Z3 HB	5163222	○	14,00	14,00	83,00	22,00	36,00	0,28	3	HB
UPN16.026.092 Cx Z3 HB	5163030	●	16,00	16,00	92,00	26,00	42,00	0,32	3	HB
UPN18.026.092 Cx Z3 HB	5163224	○	18,00	18,00	92,00	26,00	42,00	0,36	3	HB
UPN20.032.104 Cx Z3 HB	5163225	⊙	20,00	20,00	104,00	32,00	52,00	0,40	3	HB

Bestellbeispiel Order example: 1 Stück piece 5163004 oder or UPN03.007.057 Cx Z3 HB

Genaue Schnittwertempfehlung siehe Seite 212

Detailed cutting recommendations, see page 212

* Ausführung ohne Hals

* Version without neck

● Verfügbar ab Lager Available from stock

⊙ Kurzfristig lieferbar Available at short notice

○ Lieferzeit auf Anfrage Delivery time on request

Schnittwertempfehlung für Eckfräser, Vorschub und Schnittgeschwindigkeit
Recommended cutting values for corner milling cutters, feed and cutting speed

**UNitec short Z2/Z3, long Z2/Z3,
 long neck Z3, extra long Z3**

Werkzeuglänge/ Korrekturfaktor: Tool length/Correction factor:	
Länge Length	f_z & v_c
kurz short	1
lang long	0,9
überlang extra long	0,8
extra lang ultra long	0,6

Nutfräsen
 Groove milling

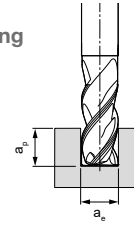

$$a_p = 1 \times D$$

$$a_e = 1 \times D$$

BZG	Kühlung Cooling			v_c [m/min]	f_z [mm/Zahn] f_z [mm/tooth]								
	MMS/Luft MMS/Air	Trocken Dry	Nass Wet		Fräserdurchmesser [mm] Cutter diameter [mm]								
					2	4	6	8	10	12	16	20	
P	P1	●	●	●	115 - 140	0,010	0,018	0,026	0,034	0,041	0,048	0,060	0,069
	P2	●	●	●	90 - 125	0,010	0,018	0,026	0,034	0,041	0,048	0,060	0,069
	P3	●	●	●	70 - 80	0,010	0,018	0,025	0,032	0,039	0,045	0,057	0,066
	P4	●		●	55	0,007	0,012	0,018	0,023	0,027	0,032	0,040	0,046
	P5			●	55 - 85	0,010	0,018	0,025	0,033	0,040	0,046	0,058	0,067
M	M1	●		●	40	0,006	0,011	0,015	0,020	0,024	0,028	0,035	0,040
	M2			●	35 - 40	0,005	0,009	0,013	0,016	0,020	0,023	0,029	0,033
K	K1	●	●	●	150	0,017	0,031	0,044	0,056	0,068	0,080	0,100	0,115
	K2	●	●	●	65 - 140	0,015	0,026	0,037	0,048	0,058	0,068	0,085	0,098
	K3	●	●	●	95 - 100	0,012	0,022	0,031	0,039	0,048	0,056	0,070	0,081
N	N1	●	●	●	525	0,017	0,031	0,044	0,056	0,068	0,080	0,100	0,115
	N3	●	●	●	200 - 350	0,018	0,032	0,046	0,059	0,072	0,084	0,105	0,121
	N2	●	●	●	150 - 250	0,014	0,025	0,035	0,045	0,055	0,064	0,080	0,092

UNitec short Z4, Unitec long Z4

Werkzeuglänge/ Korrekturfaktor: Tool length/Correction factor:	
Länge Length	f_z & v_c
kurz short	1
lang long	0,9
überlang extra long	0,8
extra lang ultra long	0,6

Nutfräsen
 Groove milling

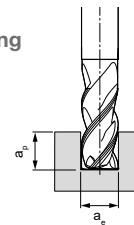

$$a_p = 1 \times D$$

$$a_e = 1 \times D$$

BZG	Kühlung Cooling			v_c [m/min]	f_z [mm/Zahn] f_z [mm/tooth]								
	MMS/Luft MMS/Air	Trocken Dry	Nass Wet		Fräserdurchmesser [mm] Cutter diameter [mm]								
					2	4	6	8	10	12	16	20	
P	P1	●	●	●	140 - 170	0,012	0,021	0,030	0,038	0,046	0,054	0,067	0,078
	P2	●	●	●	105 - 155	0,012	0,021	0,030	0,038	0,046	0,054	0,067	0,078
	P3	●	●	●	85 - 100	0,011	0,020	0,028	0,036	0,044	0,051	0,064	0,074
	P4	●		●	70	0,008	0,014	0,020	0,025	0,031	0,036	0,045	0,052
	P5			●	70 - 105	0,011	0,020	0,029	0,037	0,045	0,052	0,065	0,075
M	M1	●		●	45 - 50	0,007	0,012	0,017	0,022	0,027	0,031	0,039	0,045
	M2			●	45	0,006	0,010	0,014	0,018	0,022	0,026	0,033	0,038
K	K1	●	●	●	185	0,020	0,035	0,049	0,063	0,077	0,090	0,112	0,130
	K2	●	●	●	75 - 170	0,017	0,029	0,042	0,054	0,065	0,076	0,095	0,110
	K3	●	●	●	115 - 120	0,014	0,024	0,034	0,044	0,054	0,063	0,078	0,091

Schruppen
Roughing

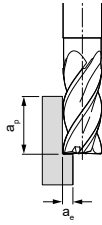

$$a_p = 1,5 \times D$$

$$a_e = 0,25 \times D$$

Schlichten
Finishing

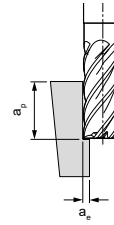

$$a_p = 1,5 \times D$$

$$a_e = 0,1 \times D$$

	v_c [m/min]	f_z [mm/Zahn] f_z [mm/tooth]								v_c [m/min]	f_z [mm/Zahn] f_z [mm/tooth]							
		Fräserdurchmesser [mm] Cutter diameter [mm]									Fräserdurchmesser [mm] Cutter diameter [mm]							
		2	4	6	8	10	12	16	20		2	4	6	8	10	12	16	20
	230 - 285	0,018	0,031	0,045	0,057	0,070	0,081	0,101	0,118	340 - 415	0,028	0,050	0,070	0,091	0,110	0,128	0,160	0,186
	180 - 260	0,018	0,031	0,045	0,057	0,070	0,081	0,101	0,118	265 - 380	0,028	0,050	0,070	0,091	0,110	0,128	0,160	0,186
	140 - 165	0,017	0,030	0,042	0,054	0,066	0,077	0,096	0,112	210 - 245	0,027	0,047	0,067	0,086	0,104	0,122	0,152	0,177
	115	0,012	0,021	0,030	0,038	0,046	0,054	0,068	0,078	170	0,019	0,033	0,047	0,060	0,073	0,085	0,107	0,124
	115 - 175	0,017	0,030	0,043	0,055	0,067	0,078	0,098	0,114	170 - 255	0,027	0,048	0,068	0,088	0,106	0,124	0,155	0,180
	75 - 85	0,010	0,018	0,026	0,033	0,041	0,047	0,059	0,069	115 - 125	0,016	0,029	0,041	0,053	0,064	0,075	0,094	0,108
	70 - 75	0,009	0,015	0,022	0,028	0,034	0,039	0,049	0,057	105 - 115	0,014	0,024	0,034	0,044	0,053	0,062	0,077	0,090
	310	0,030	0,052	0,074	0,096	0,116	0,135	0,169	0,196	455	0,047	0,083	0,117	0,151	0,183	0,214	0,267	0,310
	130 - 285	0,025	0,044	0,063	0,081	0,099	0,115	0,144	0,166	190 - 415	0,040	0,070	0,100	0,128	0,156	0,182	0,227	0,263
	195 - 205	0,021	0,037	0,052	0,067	0,081	0,095	0,118	0,137	285 - 300	0,033	0,058	0,082	0,106	0,128	0,149	0,187	0,217
	1075	0,030	0,052	0,074	0,096	0,116	0,135	0,169	0,196	1580	0,047	0,083	0,117	0,151	0,183	0,214	0,267	0,310
	410 - 715	0,031	0,055	0,078	0,100	0,122	0,142	0,177	0,206	605 - 1050	0,049	0,087	0,123	0,159	0,192	0,224	0,281	0,325
	310 - 515	0,024	0,042	0,059	0,076	0,093	0,108	0,135	0,157	455 - 755	0,037	0,066	0,094	0,121	0,147	0,171	0,214	0,248

Schruppen
Roughing

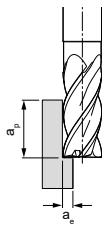

$$a_p = 1,5 \times D$$

$$a_e = 0,25 \times D$$

Schlichten
Finishing

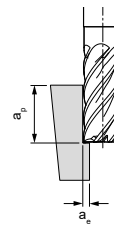

$$a_p = 1,5 \times D$$

$$a_e = 0,1 \times D$$

	v_c [m/min]	f_z [mm/Zahn] f_z [mm/tooth]								v_c [m/min]	f_z [mm/Zahn] f_z [mm/tooth]							
		Fräserdurchmesser [mm] Cutter diameter [mm]									Fräserdurchmesser [mm] Cutter diameter [mm]							
		2	4	6	8	10	12	16	20		2	4	6	8	10	12	16	20
	280 - 345	0,020	0,035	0,050	0,065	0,078	0,091	0,114	0,132	415 - 505	0,031	0,056	0,079	0,102	0,124	0,144	0,180	0,209
	220 - 315	0,020	0,035	0,050	0,065	0,078	0,091	0,114	0,132	320 - 460	0,031	0,056	0,079	0,102	0,124	0,144	0,180	0,209
	170 - 205	0,019	0,033	0,048	0,061	0,074	0,087	0,108	0,126	250 - 300	0,030	0,053	0,075	0,097	0,118	0,137	0,171	0,199
	140	0,013	0,023	0,033	0,043	0,052	0,061	0,076	0,088	205	0,021	0,037	0,053	0,068	0,082	0,096	0,120	0,139
	140 - 210	0,019	0,034	0,048	0,062	0,076	0,088	0,110	0,128	205 - 310	0,030	0,054	0,077	0,099	0,120	0,139	0,174	0,202
	95 - 105	0,012	0,021	0,029	0,038	0,046	0,053	0,067	0,077	140 - 150	0,018	0,032	0,046	0,060	0,072	0,084	0,105	0,122
	90 - 95	0,010	0,017	0,024	0,031	0,038	0,044	0,055	0,064	130 - 140	0,015	0,027	0,038	0,049	0,060	0,070	0,087	0,101
	375	0,033	0,059	0,084	0,108	0,130	0,152	0,190	0,220	550	0,052	0,093	0,132	0,170	0,206	0,24	0,301	0,348
	155 - 345	0,028	0,050	0,071	0,091	0,111	0,129	0,162	0,187	230 - 505	0,045	0,079	0,112	0,145	0,175	0,204	0,256	0,296
	235 - 250	0,023	0,041	0,059	0,075	0,091	0,106	0,133	0,154	345 - 365	0,037	0,065	0,092	0,119	0,144	0,168	0,210	0,244

* Angegebene Schnittdaten sind als Richtwert zu sehen, welche durch Versuche für jeden Anwendungsfall separat optimiert werden können.
 * Recommended cutting data has to be seen as a reference which can be optimised for each application through trials separately.

Schnittwertempfehlung für Eckfräser, Vorschub und Schnittgeschwindigkeit
Recommended cutting values for corner milling cutters, feed and cutting speed

UNItéc Pro slot long neck Z3

Werkzeuglänge/ Korrekturfaktor: Tool length/Correction factor:	
Länge Length	f_z & v_c
kurz short	1
lang long	0,9
überlang extra long	0,8
extra lang ultra long	0,6

Nutfräsen
 Groove milling

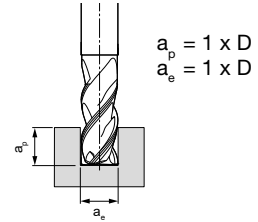

BZG	Kühlung Cooling			v_c [m/min]	f_z [mm/Zahn] f_z [mm/tooth]							
	MMS/Luft MMS/Air	Trocken Dry	Nass Wet		Fräserdurchmesser [mm] Cutter diameter [mm]							
					2	4	6	8	10	12	16	20
P1	●	●	●	160 - 200	0,013	0,023	0,033	0,042	0,051	0,060	0,075	0,087
P2	●	●	●	125 - 180	0,013	0,023	0,033	0,042	0,051	0,060	0,075	0,087
P3	●	●	●	100 - 115	0,012	0,022	0,031	0,040	0,049	0,057	0,071	0,082
P4	●		●	80	0,009	0,015	0,022	0,028	0,034	0,040	0,050	0,058
P5			●	80 - 120	0,013	0,022	0,032	0,041	0,050	0,058	0,072	0,084
M1	●		●	55 - 60	0,008	0,013	0,019	0,025	0,030	0,035	0,044	0,051
M2			●	50 - 55	0,006	0,011	0,016	0,020	0,025	0,029	0,036	0,042
K1	●	●	●	215	0,022	0,038	0,055	0,070	0,085	0,100	0,125	0,144
K2	●	●	●	90 - 200	0,018	0,033	0,047	0,060	0,073	0,085	0,106	0,123
K3	●	●	●	135 - 145	0,015	0,027	0,038	0,049	0,060	0,070	0,087	0,101

UNItéc Pro
 short Z4, long neck Z4, long neck FR Z4,
 overlength neck Z4, extra long neck Z4

Werkzeuglänge/ Korrekturfaktor: Tool length/Correction factor:	
Länge Length	f_z & v_c
kurz short	1
lang long	0,9
überlang extra long	0,8
extra lang ultra long	0,6

Nutfräsen
 Groove milling

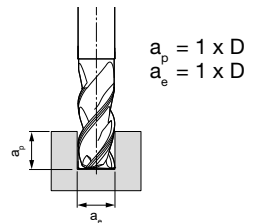

BZG	Kühlung Cooling			v_c [m/min]	f_z [mm/Zahn] f_z [mm/tooth]							
	MMS/Luft MMS/Air	Trocken Dry	Nass Wet		Fräserdurchmesser [mm] Cutter diameter [mm]							
					2	4	6	8	10	12	16	20
P1	●	●	●	180 - 220	0,016	0,029	0,041	0,053	0,064	0,075	0,093	0,108
P2	●	●	●	140 - 200	0,016	0,029	0,041	0,053	0,064	0,075	0,093	0,108
P3	●	●	●	110 - 130	0,015	0,027	0,039	0,050	0,061	0,071	0,089	0,103
P4	●		●	90	0,011	0,019	0,027	0,035	0,043	0,050	0,062	0,072
P5			●	90 - 135	0,016	0,028	0,040	0,051	0,062	0,072	0,090	0,105
M1	●		●	60 - 65	0,010	0,017	0,024	0,031	0,037	0,044	0,054	0,063
M2			●	55 - 60	0,008	0,014	0,020	0,026	0,031	0,036	0,045	0,052
K1	●	●	●	240	0,027	0,048	0,068	0,088	0,107	0,124	0,156	0,180
K2	●	●	●	100 - 220	0,023	0,041	0,058	0,075	0,091	0,106	0,132	0,153
K3	●	●	●	150 - 160	0,019	0,034	0,048	0,062	0,075	0,087	0,109	0,126

Schruppen
Roughing

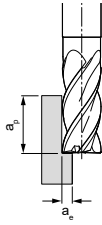

$$a_p = 1,5 \times D$$

$$a_e = 0,25 \times D$$

Schlichten
Finishing

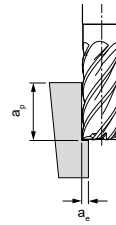

$$a_p = 1,5 \times D$$

$$a_e = 0,1 \times D$$

	v_c [m/min]	f_z [mm/Zahn] f_z [mm/tooth]								v_c [m/min]	f_z [mm/Zahn] f_z [mm/tooth]							
		Fräserdurchmesser [mm] Cutter diameter [mm]									Fräserdurchmesser [mm] Cutter diameter [mm]							
		2	4	6	8	10	12	16	20		2	4	6	8	10	12	16	20
330 - 405	0,022	0,039	0,056	0,072	0,087	0,101	0,127	0,147	485 - 595	0,035	0,062	0,088	0,113	0,137	0,160	0,200	0,232	
260 - 370	0,022	0,039	0,056	0,072	0,087	0,101	0,127	0,147	380 - 540	0,035	0,062	0,088	0,113	0,137	0,160	0,200	0,232	
200 - 240	0,021	0,037	0,053	0,068	0,083	0,096	0,120	0,140	295 - 350	0,033	0,059	0,084	0,108	0,131	0,152	0,190	0,221	
165	0,015	0,026	0,037	0,048	0,058	0,068	0,085	0,098	245	0,023	0,041	0,059	0,076	0,092	0,107	0,134	0,155	
165 - 245	0,021	0,038	0,054	0,069	0,084	0,098	0,123	0,142	245 - 360	0,034	0,060	0,085	0,110	0,133	0,155	0,194	0,225	
110 - 120	0,013	0,023	0,033	0,042	0,051	0,059	0,074	0,086	160 - 180	0,020	0,036	0,051	0,066	0,080	0,093	0,117	0,135	
105 - 110	0,011	0,019	0,027	0,035	0,042	0,049	0,061	0,071	150 - 160	0,017	0,030	0,043	0,055	0,066	0,077	0,097	0,112	
440	0,037	0,065	0,093	0,119	0,145	0,169	0,211	0,245	650	0,058	0,103	0,147	0,189	0,229	0,267	0,334	0,387	
185 - 405	0,031	0,055	0,079	0,102	0,123	0,144	0,180	0,208	270 - 595	0,050	0,088	0,125	0,161	0,195	0,227	0,284	0,329	
275 - 295	0,026	0,046	0,065	0,084	0,101	0,118	0,148	0,171	405 - 430	0,041	0,072	0,103	0,132	0,160	0,187	0,234	0,271	

Schruppen
Roughing

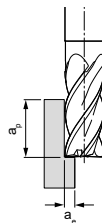

$$a_p = 1,5 \times D$$

$$a_e = 0,25 \times D$$

Schlichten
Finishing

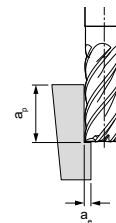

$$a_p = 1,5 \times D$$

$$a_e = 0,1 \times D$$

	v_c [m/min]	f_z [mm/Zahn] f_z [mm/tooth]								v_c [m/min]	f_z [mm/Zahn] f_z [mm/tooth]							
		Fräserdurchmesser [mm] Cutter diameter [mm]									Fräserdurchmesser [mm] Cutter diameter [mm]							
		2	4	6	8	10	12	16	20		2	4	6	8	10	12	16	20
365 - 445	0,028	0,049	0,070	0,090	0,109	0,127	0,158	0,184	535 - 655	0,044	0,077	0,110	0,142	0,172	0,200	0,251	0,290	
285 - 405	0,028	0,049	0,070	0,090	0,109	0,127	0,158	0,184	415 - 595	0,044	0,077	0,110	0,142	0,172	0,200	0,251	0,290	
225 - 265	0,026	0,046	0,066	0,085	0,103	0,120	0,151	0,174	325 - 385	0,042	0,073	0,105	0,135	0,163	0,190	0,238	0,276	
180	0,018	0,033	0,046	0,060	0,072	0,084	0,106	0,122	265	0,029	0,052	0,073	0,094	0,115	0,133	0,167	0,194	
180 - 270	0,027	0,047	0,067	0,087	0,105	0,122	0,153	0,177	265 - 400	0,042	0,075	0,106	0,137	0,166	0,194	0,242	0,281	
120 - 135	0,016	0,029	0,041	0,052	0,063	0,074	0,092	0,107	180 - 195	0,026	0,045	0,064	0,083	0,100	0,117	0,146	0,169	
115 - 120	0,013	0,024	0,034	0,043	0,053	0,061	0,077	0,089	165 - 180	0,021	0,037	0,053	0,068	0,083	0,097	0,121	0,140	
485	0,046	0,082	0,116	0,149	0,181	0,211	0,264	0,306	715	0,073	0,129	0,184	0,236	0,286	0,334	0,418	0,484	
200 - 445	0,039	0,069	0,099	0,127	0,154	0,179	0,224	0,260	295 - 655	0,062	0,110	0,156	0,201	0,243	0,284	0,355	0,411	
305 - 325	0,032	0,057	0,081	0,105	0,127	0,148	0,185	0,214	445 - 475	0,051	0,090	0,128	0,165	0,200	0,234	0,292	0,339	

* Angegebene Schnittdaten sind als Richtwert zu sehen, welche durch Versuche für jeden Anwendungsfall separat optimiert werden können.
 * Recommended cutting data has to be seen as a reference which can be optimised for each application through trials separately.

Schnittwertempfehlung für Eckfräser, Vorschub und Schnittgeschwindigkeit
Recommended cutting values for corner milling cutters, feed and cutting speed

MULTItec Universal
 short Z3, long neck Z3, overlength neck Z3

Werkzeuflänge/ Korrekturfaktor: Tool length/Correction factor:	
Länge Length	f_z & v_c
kurz short	1
lang long	1
überlang extra long	0,8
extra lang ultra long	-

Teilschnitt
 Partial cut

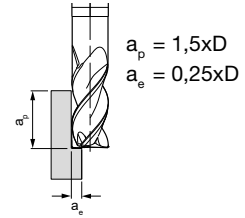

BZG		Kühlung Cooling			v_c [m/min]	f_z [mm/Zahn] f_z [mm/tooth]					
		MMS/Luft MMS/Air	Trocken Dry	Nass Wet		Fräserdurchmesser [mm] Cutter diameter [mm]					
						6	8	10	12	16	20
P	P1	●	●	●	365 - 445	0,070	0,090	0,109	0,127	0,158	0,184
	P2	●	●	●	285 - 405	0,070	0,090	0,109	0,127	0,158	0,184
	P3	●	●	●	225 - 265	0,066	0,085	0,103	0,120	0,151	0,174
	P4	●		●	180	0,046	0,060	0,072	0,084	0,106	0,122
	P5			●	180 - 270	0,067	0,087	0,105	0,122	0,153	0,177
M	M1	●		●	120 - 135	0,041	0,052	0,063	0,074	0,092	0,107
	M2			●	115 - 120	0,034	0,043	0,053	0,061	0,077	0,089
K	K1	●	●	●	485	0,116	0,149	0,181	0,211	0,264	0,306
	K2	●	●	●	200 - 445	0,099	0,127	0,154	0,179	0,224	0,260
	K3	●	●	●	305 - 325	0,081	0,105	0,127	0,148	0,185	0,214

UNItec Pro Silence long neck Z5

Werkzeuflänge/ Korrekturfaktor: Tool length/Correction factor:	
Länge Length	f_z & v_c
kurz short	1
lang long	0,9
überlang extra long	0,8
extra lang ultra long	0,6

Nutfräsen – Teilnut
 Groove milling -
 Partial groove

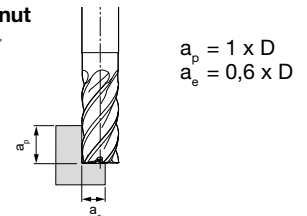

BZG		Kühlung Cooling			v_c [m/min]	f_z [mm/Zahn] f_z [mm/tooth]								
		MMS/Luft MMS/Air	Trocken Dry	Nass Wet		Fräserdurchmesser [mm] Cutter diameter [mm]								
						2	4	6	8	10	12	16	20	25
P	P1	●	●	●	190 - 230	-	-	0,042	0,055	0,066	0,077	0,096	0,112	0,124
	P2	●	●	●	145 - 210	-	-	0,042	0,055	0,066	0,077	0,096	0,112	0,124
	P3	●	●	●	115 - 135	-	-	0,040	0,052	0,063	0,073	0,092	0,106	0,118
	P4	●		●	95	-	-	0,028	0,036	0,044	0,051	0,064	0,075	0,083
	P5			●	95 - 140	-	-	0,041	0,053	0,064	0,075	0,093	0,108	0,120
M	M1	●		●	65 - 70	-	-	0,025	0,032	0,039	0,045	0,056	0,065	0,072
	M2			●	60 - 65	-	-	0,020	0,026	0,032	0,037	0,047	0,054	0,06
K	K1	●	●	●	250	-	-	0,071	0,091	0,110	0,128	0,161	0,186	0,206
	K2	●	●	●	105 - 230	-	-	0,060	0,077	0,094	0,109	0,137	0,158	0,175
	K3	●	●	●	160 - 170	-	-	0,049	0,064	0,077	0,090	0,113	0,130	0,144

**Vollschnitt
Full cut**

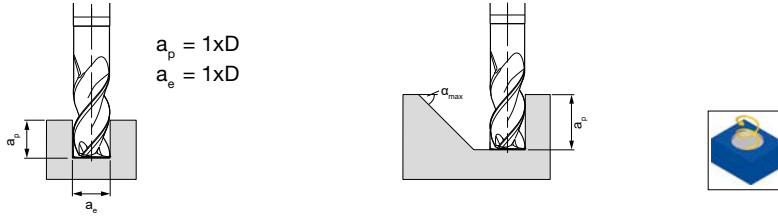

$$a_p = 1 \times D$$

$$a_e = 1 \times D$$

v_c [m/min]	f_z [mm/Zahn] f_z [mm/tooth]							Rampen Ramping	Helikales Eintauchen Helikal ramping in	Bohren Drilling
	Fräserdurchmesser [mm] Cutter diameter [mm]							α_{max} [°]	APMX max helix [mm]	f_z Faktor
	6	8	10	12	16	20				
180 - 220	0,041	0,053	0,064	0,075	0,093	0,108	45°	0,75xD	0,90	
140 - 200	0,041	0,053	0,064	0,075	0,093	0,108	45°	0,75xD	0,80	
110 - 130	0,039	0,050	0,061	0,071	0,089	0,103	30°	0,5xD	0,80	
90	0,027	0,035	0,043	0,050	0,062	0,072	15°	0,5xD		
90 - 135	0,040	0,051	0,062	0,072	0,090	0,105	30°	0,5xD		
60 - 65	0,024	0,031	0,037	0,044	0,054	0,063	15°	0,5xD		
55 - 60	0,020	0,026	0,031	0,036	0,045	0,052	15°	0,5xD		
240	0,068	0,088	0,107	0,124	0,156	0,180	45°	0,75xD	0,80	
100 - 220	0,058	0,075	0,091	0,106	0,132	0,153	45°	0,75xD	0,80	
150 - 160	0,048	0,062	0,075	0,087	0,109	0,126	45°	0,75xD	0,80	

**Schruppen
Roughing**

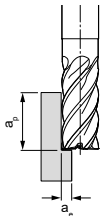

$$a_p = 1,5 \times D$$

$$a_e = 0,25 \times D$$

**Schlichten
Finishing**

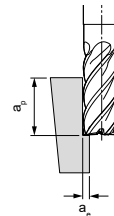

$$a_p = 1,5 \times D$$

$$a_e = 0,1 \times D$$

v_c [m/min]	f_z [mm/Zahn] f_z [mm/tooth]										v_c [m/min]	f_z [mm/Zahn] f_z [mm/tooth]								
	Fräserdurchmesser [mm] Cutter diameter [mm]											Fräserdurchmesser [mm] Cutter diameter [mm]								
	2	4	6	8	10	12	16	20	25	2		4	6	8	10	12	16	20	25	
330 - 405	-	-	0,056	0,072	0,087	0,101	0,127	0,147	0,163	485 - 595	-	-	0,088	0,113	0,137	0,160	0,200	0,232	0,257	
260 - 370	-	-	0,056	0,072	0,087	0,101	0,127	0,147	0,163	380 - 540	-	-	0,088	0,113	0,137	0,160	0,200	0,232	0,257	
200 - 240	-	-	0,053	0,068	0,083	0,096	0,120	0,140	0,155	295 - 350	-	-	0,084	0,108	0,131	0,152	0,190	0,221	0,244	
165	-	-	0,037	0,048	0,058	0,068	0,085	0,098	0,108	245	-	-	0,059	0,076	0,092	0,107	0,134	0,155	0,172	
165 - 245	-	-	0,054	0,069	0,084	0,098	0,123	0,142	0,157	245 - 360	-	-	0,085	0,110	0,133	0,155	0,194	0,225	0,249	
110 - 120	-	-	0,033	0,042	0,051	0,059	0,074	0,086	0,095	160 - 180	-	-	0,051	0,066	0,080	0,093	0,117	0,135	0,150	
105 - 110	-	-	0,027	0,035	0,042	0,049	0,061	0,071	0,079	150 - 160	-	-	0,043	0,055	0,066	0,077	0,097	0,112	0,124	
440	-	-	0,093	0,119	0,145	0,169	0,211	0,245	0,271	650	-	-	0,147	0,189	0,229	0,267	0,334	0,387	0,429	
185 - 405	-	-	0,079	0,102	0,123	0,144	0,180	0,208	0,231	270 - 595	-	-	0,125	0,161	0,195	0,227	0,284	0,329	0,365	
275 - 295	-	-	0,065	0,084	0,101	0,118	0,148	0,171	0,190	405 - 430	-	-	0,103	0,132	0,160	0,187	0,234	0,271	0,300	

* Angegebene Schnittdaten sind als Richtwert zu sehen, welche durch Versuche für jeden Anwendungsfall separat optimiert werden können.
 * Recommended cutting data has to be seen as a reference which can be optimised for each application through trials separately.

Schnittwertempfehlung für Eckfräser, Vorschub und Schnittgeschwindigkeit
Recommended cutting values for corner milling cutters, feed and cutting speed

Teilschnitt
 Partial cut

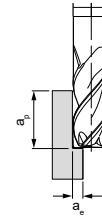

$a_p = 1,5xD$
 $a_e = 0,25xD$

MULTItec N long neck Z3

BZG	Kühlung Cooling			v_c [m/min]	f_z [mm/Zahn] f_z [mm/tooth]					
	MMS/Luft MMS/Air	Trocken Dry	Nass Wet		Fräserdurchmesser [mm] Cutter diameter [mm]					
					5	8	10	12	16	20
N1	●	●	●	945	0,080	0,120	0,145	0,169	0,210	0,243
N2	●	●	●	360 - 625	0,084	0,126	0,152	0,177	0,221	0,256
N3	●	●	●	270 - 450	0,064	0,096	0,116	0,135	0,168	0,195

Nutfräsen
 Groove milling

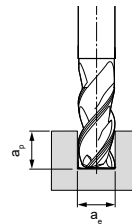

$a_p = 1 \times D$
 $a_e = 1 \times D$

UNItec N long Z2

BZG	Kühlung Cooling			v_c [m/min]	f_z [mm/Zahn] f_z [mm/tooth]							
	MMS/Luft MMS/Air	Trocken Dry	Nass Wet		Fräserdurchmesser [mm] Cutter diameter [mm]							
					2	4	6	8	10	12	16	20
N1	●	●	●	600	0,017	0,031	0,044	0,056	0,068	0,080	0,100	0,115
N2	●	●	●	230 - 400	0,018	0,032	0,046	0,059	0,072	0,084	0,105	0,121
N3	●	●	●	175 - 290	0,014	0,025	0,035	0,045	0,055	0,064	0,080	0,092

Werkzeuglänge/ Korrekturfaktor: Tool length/Correction factor:	
Länge Length	f_z & v_c
kurz short	1
lang long	0,9
überlang extra long	0,8
extra lang ultra long	0,6

Nutfräsen
 Groove milling

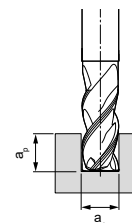

$a_p = 1 \times D$
 $a_e = 1 \times D$

UNItec Pro N long neck Z3

BZG	Kühlung Cooling			v_c [m/min]	f_z [mm/Zahn] f_z [mm/tooth]							
	MMS/Luft MMS/Air	Trocken Dry	Nass Wet		Fräserdurchmesser [mm] Cutter diameter [mm]							
					2	4	6	8	10	12	16	20
N1	●	●	●	755	0,022	0,038	0,055	0,070	0,085	0,100	0,125	0,144
N2	●	●	●	290 - 500	0,023	0,040	0,057	0,074	0,090	0,105	0,131	0,152
N3	●	●	●	215 - 360	0,017	0,031	0,044	0,056	0,068	0,080	0,100	0,115

Vollschnitt
Full cut

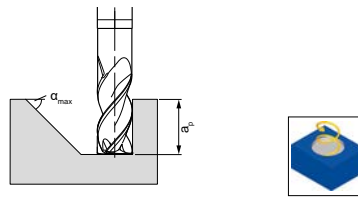
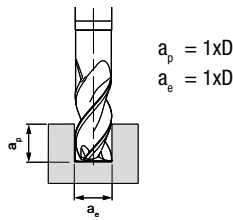

v_c [m/min]	f_z [mm/Zahn] f_z [mm/tooth]							Rampen Ramping	Helikales Eintauchen helikal ramping in	Bohren Drilling
	Fräserdurchmesser [mm] Cutter diameter [mm]							α_{max} [°]	APMX max helix [mm]	f_z Faktor
	5	8	10	12	16	20				
610	0,047	0,071	0,086	0,099	0,124	0,144	45°	0,75xD	0,8	
235 - 405	0,049	0,074	0,090	0,104	0,130	0,151	45°	0,75xD	0,8	
175 - 295	0,038	0,057	0,068	0,080	0,099	0,115	45°	0,75xD	0,8	

Schruppen
Roughing

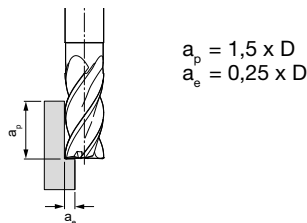

Schlichten
Finishing

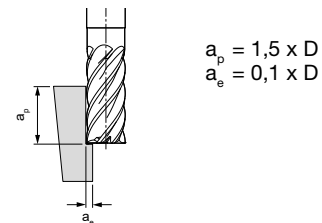

v_c [m/min]	f_z [mm/Zahn] f_z [mm/tooth]								v_c [m/min]	f_z [mm/Zahn] f_z [mm/tooth]							
	Fräserdurchmesser [mm] Cutter diameter [mm]									Fräserdurchmesser [mm] Cutter diameter [mm]							
	2	4	6	8	10	12	16	20		2	4	6	8	10	12	16	20
1230	0,030	0,052	0,074	0,096	0,116	0,135	0,169	0,196	1805	0,047	0,083	0,117	0,151	0,183	0,214	0,267	0,310
470 - 820	0,031	0,055	0,078	0,100	0,122	0,142	0,177	0,206	690 - 1200	0,049	0,087	0,123	0,159	0,192	0,224	0,281	0,325
355 - 590	0,024	0,042	0,059	0,076	0,093	0,108	0,135	0,157	520 - 865	0,037	0,066	0,094	0,121	0,147	0,171	0,214	0,248

Schruppen
Roughing

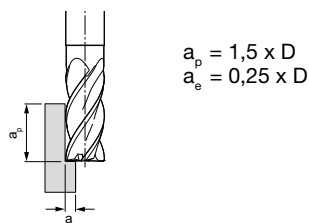

Schlichten
Finishing

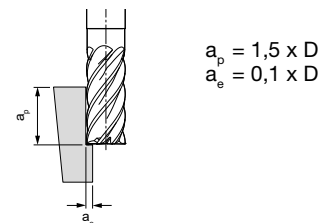

v_c [m/min]	f_z [mm/Zahn] f_z [mm/tooth]									v_c [m/min]	f_z [mm/Zahn] f_z [mm/tooth]								
	Fräserdurchmesser [mm] Cutter diameter [mm]										Fräserdurchmesser [mm] Cutter diameter [mm]								
	2	4	6	8	10	12	16	20	2		4	6	8	10	12	16	20		
1540	0,037	0,065	0,093	0,119	0,145	0,169	0,211	0,245	2255	0,058	0,103	0,147	0,189	0,229	0,267	0,334	0,387		
590 - 1025	0,039	0,069	0,098	0,125	0,152	0,177	0,222	0,257	865 - 1500	0,061	0,108	0,154	0,198	0,241	0,280	0,351	0,406		
440 - 735	0,030	0,052	0,074	0,096	0,116	0,135	0,169	0,196	650 - 1080	0,047	0,083	0,117	0,151	0,183	0,214	0,267	0,310		

* Angegebene Schnittdaten sind als Richtwert zu sehen, welche durch Versuche für jeden Anwendungsfall separat optimiert werden können.
* Recommended cutting data has to be seen as a reference which can be optimised for each application through trials separately.



Eckfräsen - Schruppen
Edge milling - Roughing



Eckfräsen - Schruppen Edge milling roughing	
UNItec Pro	
	
Zähnezahl Amount teeth	Z3, Z4
P.1	■
P.2	■
P.3	■
P.4	■
P.5	■
M.1	■
M.2	■
K.1	■
K.2	■
K.3	■

UNItec Pro rough short neck

Kurze Ausführung mit Hals Z3/Z4

Execution short neck Z3/Z4

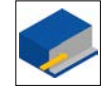
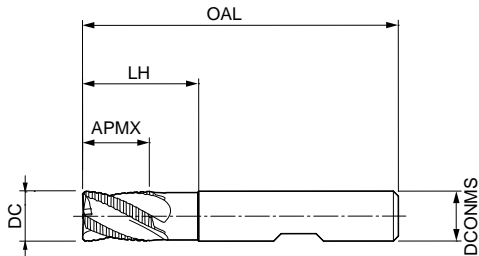

Hard Facts	
Fräserdurchmesser:	5,00 - 20,00 mm
Beschichtung:	AlCrN PVD
Schneidenzahl:	Z = 3 ≤ ø 8 mm Z = 4 ≥ ø 9 mm
Drallwinkel:	30°
Besonderheiten:	Ungleichteilung, Profilhinterschliffene HPC-Schruppverzahnung
Diameter:	5.00 - 20.00 mm
Coating:	AlCrN PVD
Amount/Teeth:	Z = 3 ≤ ø 8 mm Z = 4 ≥ ø 9 mm
Helix angle:	30°
Special feature:	Unequal division, special HPC roughing geometry

UNItec Pro rough short neck		
ISO		
P	P.1	■
	P.2	■
	P.3	■
	P.4	■
	P.5	■
M	M.1	■
	M.2	■
K	K.1	■
	K.2	■
	K.3	■

Artikelbezeichnung Item Code	Bestell-Nr. Ordering No.	Verfügbarkeit Availability	Abmessungen [mm] Dimensions [mm]						ZEFF [⊙]	Schaft Shank
			DC	DCONMS	OAL	APMX	LH	Cx 45°		
UPR05.008.054 Cx Z3 HB	5163341	⊙	*5,00	6,00	54,00	8,00	-	0,30	3	HB
UPR06.008.054 Cx Z3 HB	5163342	⊙	6,00	6,00	54,00	8,00	18,00	0,30	3	HB
UPR07.011.058 Cx Z3 HB	5163343	⊙	*7,00	8,00	58,00	11,00	-	0,30	3	HB
UPR08.011.058 Cx Z3 HB	5163344	⊙	8,00	8,00	58,00	11,00	22,00	0,30	3	HB
UPR09.013.066 Cx Z4 HB	5163345	⊙	*9,00	10,00	66,00	13,00	-	0,50	4	HB
UPR10.013.066 Cx Z4 HB	5163346	⊙	10,00	10,00	66,00	13,00	26,00	0,50	4	HB
UPR12.016.073 Cx Z4 HB	5163347	⊙	12,00	12,00	73,00	16,00	28,00	0,50	4	HB
UPR14.016.076 Cx Z4 HB	5163348	⊙	14,00	14,00	76,00	16,00	31,00	0,50	4	HB
UPR16.019.082 Cx Z4 HB	5163349	⊙	16,00	16,00	82,00	19,00	34,00	0,50	4	HB
UPR18.019.084 Cx Z4 HB	5163350	⊙	18,00	18,00	84,00	19,00	36,00	0,50	4	HB
UPR20.020.092 Cx Z4 HB	5163351	⊙	20,00	20,00	92,00	20,00	42,00	0,50	4	HB

Bestellbeispiel Order example: 1 Stück piece 5163341 oder or UP05.008.054 Cx Z3 HB

Genauere Schnittwertempfehlung siehe Seite 225

Detailed cutting recommendations, see page 225

* Ausführung ohne Hals

* Version without neck

● Verfügbar ab Lager Available from stock

⊙ Kurzfristig lieferbar Available at short notice

○ Lieferzeit auf Anfrage Delivery time on request

UNIttec Pro rough short neck

Kurze Ausführung mit Hals Z5

Execution short neck Z5

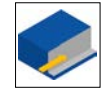
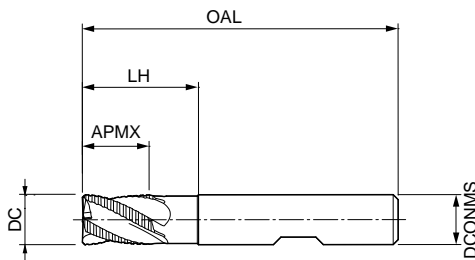

Hard Facts	
Fräserdurchmesser:	4,00 - 25,00 mm
Beschichtung:	AlCrN PVD
Schneidenzahl:	Z = 5
Drallwinkel:	41,5°
Besonderheiten:	Ungleichteilung, Profilhinterschliffene HPC-Schrappverzahnung
Diameter:	5.00 - 20.00 mm
Coating:	AlCrN PVD
Amount/Teeth:	Z = 5
Helix angle:	41,5°
Special feature:	Unequal division, special HPC roughing geometry

UNIttec Pro rough short neck		
ISO		
P	P.1	■
	P.2	■
	P.3	■
	P.4	■
	P.5	■
K	K.1	■
	K.2	■
	K.3	■

NEU

Artikelbezeichnung Item Code	Bestell-Nr. Ordering No.	Verfügbarkeit Availability	Abmessungen [mm] Dimensions [mm]					ZEFF☆	Schaft Shank
			DC	DCONMS	OAL	APMX	Cx 45°		
UPR04.008.054 Cx Z5 HB	5205937	●	4,00	6,00	54,00	8,00	0,20	5	HB
UPR05.009.054 Cx Z5 HB	5205938	●	5,00	6,00	54,00	9,00	0,25	5	HB
UPR06.010.054 Cx Z5 HB	5205939	●	6,00	6,00	54,00	10,00	0,30	5	HB
UPR07.011.058 Cx Z5 HB	5205940	●	7,00	8,00	58,00	11,00	0,35	5	HB
UPR08.012.058 Cx Z5 HB	5205941	●	8,00	8,00	58,00	12,00	0,40	5	HB
UPR09.013.066 Cx Z5 HB	5205944	●	9,00	10,00	66,00	13,00	0,45	5	HB
UPR10.014.066 Cx Z5 HB	5205945	●	10,00	10,00	66,00	14,00	0,50	5	HB
UPR12.016.073 Cx Z5 HB	5205961	●	12,00	12,00	73,00	16,00	0,60	5	HB
UPR14.018.075 Cx Z5 HB	5205962	●	14,00	14,00	75,00	18,00	0,00	5	HB
UPR16.022.082 Cx Z5 HB	5205963	●	16,00	16,00	82,00	22,00	0,80	5	HB
UPR18.024.084 Cx Z5 HB	5205964	○	18,00	18,00	84,00	24,00	0,90	5	HB
UPR20.026.092 Cx Z5 HB	5205966	●	20,00	20,00	92,00	26,00	1,00	5	HB
UPR25.032.105 Cx Z5 HB	5205967	●	25,00	25,00	105,00	32,00	1,25	5	HB

Bestellbeispiel Order example: 1 Stück piece 5205937 oder or UPR04.008.054 Cx Z5 HB

Genauere Schnittwertempfehlung siehe Seite 225
Detailed cutting recommendations, see page 225

* Ausführung ohne Hals
* Version without neck

UNItec Pro rough long neck

Lange Ausführung mit Hals Z3/Z4/Z5

Execution long neck Z3/Z4/Z5

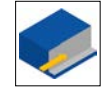
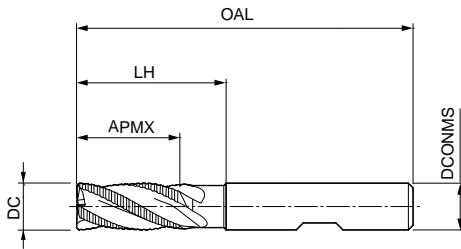

Hard Facts	
Fräserdurchmesser:	4,00 - 25,00 mm
Beschichtung:	AlCrN PVD
Schneidenzahl:	Z = 3 ≤ ø 8 mm Z = 4 ø 9 - 24,9 mm Z = 5 ≥ ø 25 mm
Drallwinkel:	30°
Besonderheiten:	Ungleichteilung, Profilhinterschliffene HPC-Schruppverzahnung
Diameter:	4.00 - 25.00 mm
Coating:	AlCrN PVD
Amount/Teeth:	Z = 3 ≤ ø 8 mm Z = 4 ø 9 - 24,9 mm Z = 5 ≥ ø 25 mm
Helix angle:	30°
Special feature:	Unequal division, special HPC roughing geometry

UNItec Pro rough long neck		
ISO		
P	P.1	■
	P.2	■
	P.3	■
	P.4	■
	P.5	■
M	M.1	■
	M.2	■
K	K.1	■
	K.2	■
	K.3	■

Artikelbezeichnung Item Code	Bestell-Nr. Ordering No.	Verfügbarkeit Availability	Abmessungen [mm] Dimensions [mm]						ZEFF [☆]	Schaft Shank
			DC	DCONMS	OAL	APMX	LH	Cx 45°		
UPR04.008.057 Cx Z3 HB	5162990	●	*4,00	6,00	57,00	8,00	-	0,30	3	HB
UPR05.013.057 Cx Z3 HB	5162992	●	*5,00	6,00	57,00	13,00	-	0,30	3	HB
UPR06.013.057 Cx Z3 HB	5162993	●	6,00	6,00	57,00	13,00	21,00	0,30	3	HB
UPR07.016.063 Cx Z3 HB	5162994	●	*7,00	8,00	63,00	16,00	-	0,30	3	HB
UPR08.016.063 Cx Z3 HB	5162995	●	8,00	8,00	63,00	16,00	26,00	0,30	3	HB
UPR09.019.072 Cx Z4 HB	5163000	●	*9,00	10,00	72,00	19,00	-	0,50	4	HB
UPR10.022.072 Cx Z4 HB	5163001	●	10,00	10,00	72,00	22,00	32,00	0,50	4	HB
UPR11.026.083 Cx Z4 HB	5163216	○	*11,00	12,00	83,00	26,00	-	0,50	4	HB
UPR12.026.083 Cx Z4 HB	5162979	●	12,00	12,00	83,00	26,00	38,00	0,50	4	HB
UPR13.026.083 Cx Z4 HB	5163217	○	*13,00	14,00	83,00	26,00	-	0,50	4	HB
UPR14.026.083 Cx Z4 HB	5163219	○	14,00	14,00	83,00	26,00	42,00	0,50	4	HB
UPR16.032.092 Cx Z4 HB	5162986	●	16,00	16,00	92,00	32,00	44,00	0,50	4	HB
UPR18.032.092 Cx Z4 HB	5163220	○	18,00	18,00	92,00	32,00	48,00	0,50	4	HB
UPR20.038.104 Cx Z4 HB	5162987	●	20,00	20,00	104,00	38,00	54,00	0,50	4	HB
UPR25.045.121 Cx Z5 HB	5163221	○	25,00	25,00	121,00	45,00	65,00	0,50	5	HB

Bestellbeispiel Order example: 1 Stück piece 5162990 oder or UPR04.008.057 Cx Z3 HB
 Genaue Schnittwertempfehlung siehe Seite 225 * Ausführung ohne Hals

Detailed cutting recommendations, see page 225

* Version without neck

● Verfügbar ab Lager Available from stock

○ Kurzfristig lieferbar Available at short notice

○ Lieferzeit auf Anfrage Delivery time on request

UNItec Pro rough long neck

Lange Ausführung mit Hals Z5

Execution long neck Z5

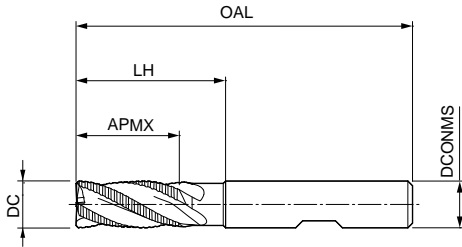

Hard Facts	
Fräserdurchmesser:	4,00 - 25,00 mm
Beschichtung:	AlCrN PVD
Schneidenzahl:	Z = 5 ≥ ø 25 mm
Drallwinkel:	41,5°
Besonderheiten:	Ungleichteilung, Profilhinterschliffene HPC-Schruppverzahnung
Diameter:	4.00 - 25.00 mm
Coating:	AlCrN PVD
Amount/Teeth:	Z = 5 ≥ ø 25 mm
Helix angle:	41,5°
Special feature:	Unequal division, special HPC roughing geometry

UNItec Pro rough long neck		
ISO		
P	P.1	■
	P.2	■
	P.3	■
	P.4	■
	P.5	■
K	K.1	■
	K.2	■
	K.3	■

NEU

Artikelbezeichnung Item Code	Bestell-Nr. Ordering No.	Verfügbarkeit Availability	Abmessungen [mm] Dimensions [mm]						ZEFF [☆]	Schaft Shank
			DC	DCONMS	OAL	APMX	LH	Cx 45°		
UPR04.011.057 Cx Z5 HB	5205968	●	4,00	6,00	57,00	11,00	19,00	0,20	5	HB
UPR05.013.057 Cx Z5 HB	5205969	●	5,00	6,00	57,00	13,00	19,00	0,25	5	HB
UPR06.013.057 Cx Z5 HB	5205970	●	6,00	6,00	57,00	13,00	19,00	0,30	5	HB
UPR07.016.063 Cx Z5 HB	5205971	●	7,00	8,00	63,00	16,00	25,00	0,35	5	HB
UPR08.019.063 Cx Z5 HB	5205972	●	8,00	8,00	63,00	19,00	25,00	0,40	5	HB
UPR09.019.072 Cx Z5 HB	5205973	●	9,00	10,00	72,00	19,00	30,00	0,45	5	HB
UPR10.022.072 Cx Z5 HB	5205975	●	10,00	10,00	72,00	22,00	30,00	0,50	5	HB
UPR12.026.083 Cx Z5 HB	5205976	●	12,00	12,00	83,00	26,00	36,00	0,60	5	HB
UPR14.026.083 Cx Z5 HB	5205978	●	14,00	14,00	83,00	26,00	36,00	0,00	5	HB
UPR16.032.092 Cx Z5 HB	5205979	●	16,00	16,00	92,00	32,00	42,00	0,80	5	HB
UPR18.032.092 Cx Z5 HB	5205980	○	18,00	18,00	92,00	32,00	42,00	0,90	5	HB
UPR20.038.104 Cx Z5 HB	5205981	●	20,00	20,00	104,00	38,00	52,00	1,00	5	HB
UPR25.050.125 Cx Z5 HB	5205982	●	25,00	25,00	125,00	50,00	65,00	1,25	5	HB

Bestellbeispiel Order example: 1 Stück piece 5205968 oder or UPR04.011.057 Cx Z5 HB

Genauere Schnittwertempfehlung siehe Seite 225

Detailed cutting recommendations, see page 225

* Ausführung ohne Hals

* Version without neck

UNItec Pro rough long neck IC (IC = mit Innenkühlung / with internal cooling)

Lange Ausführung mit Hals Z5

Execution long neck Z5

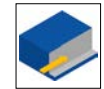
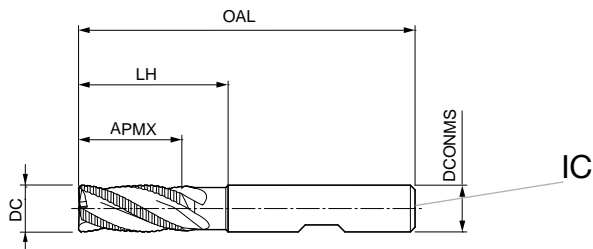

Hard Facts	
Fräserdurchmesser:	4,00 - 20,00 mm
Beschichtung:	AlCrN PVD
Schneidenzahl:	Z = 5 ≥ ø 25 mm
Drallwinkel:	41,5°
Besonderheiten:	Ungleichteilung, Profilhinterschliffene HPC-Schrappverzahnung
Diameter:	4.00 - 20.00 mm
Coating:	AlCrN PVD
Amount/Teeth:	Z = 5 ≥ ø 25 mm
Helix angle:	41,5°
Special feature:	Unequal division, special HPC roughing geometry

UNItec Pro rough long neck IC		
ISO		
P	P.1	■
	P.2	■
	P.3	■
	P.4	■
	P.5	■
K	K.1	■
	K.2	■
	K.3	■

NEU

Artikelbezeichnung Item Code	Bestell-Nr. Ordering No.	Verfügbarkeit Availability	Abmessungen [mm] Dimensions [mm]						ZEFF [☆]	Schaft Shank
			DC	DCONMS	OAL	APMX	LH	Cx 45°		
UPR04.011.057 Cx Z5 HB IC	5205985	●	4,00	6,00	57,00	11,00	19,00	0,20	5	HB
UPR05.013.057 Cx Z5 HB IC	5205987	●	5,00	6,00	57,00	13,00	19,00	0,25	5	HB
UPR06.013.057 Cx Z5 HB IC	5206006	●	6,00	6,00	57,00	13,00	19,00	0,30	5	HB
UPR08.019.063 Cx Z5 HB IC	5206007	●	8,00	8,00	63,00	19,00	25,00	0,40	5	HB
UPR10.022.072 Cx Z5 HB IC	5206008	●	10,00	10,00	72,00	22,00	30,00	0,50	5	HB
UPR12.026.083 Cx Z5 HB IC	5206009	●	12,00	12,00	83,00	26,00	36,00	0,60	5	HB
UPR14.026.083 Cx Z5 HB IC	5206010	○	14,00	14,00	83,00	26,00	36,00	0,00	5	HB
UPR16.032.092 Cx Z5 HB IC	5206011	●	16,00	16,00	92,00	32,00	42,00	0,80	5	HB
UPR20.038.104 Cx Z5 HB IC	5206012	●	20,00	20,00	104,00	38,00	52,00	1,00	5	HB

Bestellbeispiel Order example: 1 Stück piece 5205985 oder or UPR04.011.057 Cx Z5 HB IC

Genauere Schnittwertempfehlung siehe Seite 225

Detailed cutting recommendations, see page 225

* Ausführung ohne Hals

* Version without neck

● Verfügbar ab Lager Available from stock

● Kurzfristig lieferbar Available at short notice

○ Lieferzeit auf Anfrage Delivery time on request

UNIttec Pro rough neck 3xD

Ausführung 3xD mit Hals Z5

Execution 3xD neck Z5

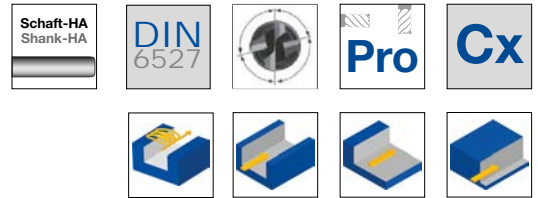
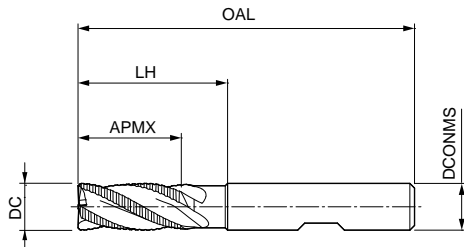

Hard Facts	
Fräserdurchmesser:	5,00 - 25,00 mm
Beschichtung:	AICrN PVD
Schneidenzahl:	Z = 5 ≥ ø 25 mm
Drallwinkel:	41,5°
Besonderheiten:	Ungleichteilung, Profilhinterschliffene HPC-Schrappverzahnung
Diameter:	5.00 - 25.00 mm
Coating:	AICrN PVD
Amount/Teeth:	Z = 5 ≥ ø 25 mm
Helix angle:	41,5°
Special feature:	Unequal division, special HPC roughing geometry

UNIttec Pro rough neck 3xD		
ISO		
P	P.1	■
	P.2	■
	P.3	■
	P.4	■
	P.5	■
K	K.1	■
	K.2	■
	K.3	■

NEU

Artikelbezeichnung Item Code	Bestell-Nr. Ordering No.	Verfügbarkeit Availability	Abmessungen [mm] Dimensions [mm]							ZEFF [⊙]	Schaft Shank
			DC	DCONMS	OAL	APMX	LH	Cx 45°			
UPR05.017.062 Cx Z5 HB	5206013	●	5,00	6,00	62,00	17,00	24,00	0,25	5	HB	
UPR06.018.062 Cx Z5 HB	5206014	●	6,00	6,00	62,00	18,00	25,00	0,30	5	HB	
UPR08.024.068 Cx Z5 HB	5206016	●	8,00	8,00	68,00	24,00	30,00	0,40	5	HB	
UPR10.030.080 Cx Z5 HB	5206017	●	10,00	10,00	80,00	30,00	35,00	0,50	5	HB	
UPR12.036.093 Cx Z5 HB	5206018	●	12,00	12,00	93,00	36,00	45,00	0,60	5	HB	
UPR14.042.099 Cx Z5 HB	5206019	●	14,00	14,00	99,00	42,00	50,00	0,70	5	HB	
UPR16.048.108 Cx Z5 HB	5206020	●	16,00	16,00	108,00	48,00	55,00	0,80	5	HB	
UPR18.054.117 Cx Z5 HB	5206026	○	18,00	18,00	117,00	54,00	67,00	0,90	5	HB	
UPR20.060.126 Cx Z5 HB	5206027	●	20,00	20,00	126,00	60,00	70,00	1,00	5	HB	
UPR25.075.150 Cx Z5 HB	5206028	○	25,00	25,00	150,00	75,00	92,00	1,25	5	HB	

Bestellbeispiel Order example: 1 Stück piece 5206013 oder or UPR05.017.062 Cx Z5 HB

Genauere Schnittwertempfehlung siehe Seite 225
Detailed cutting recommendations, see page 225

* Ausführung ohne Hals
* Version without neck

UNItec Pro rough overlength neck

Überlange Ausführung mit Hals Z5

Execution extra long neck Z5

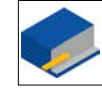
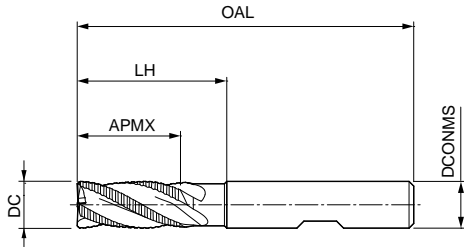

Hard Facts	
Fräserdurchmesser:	5,00 - 25,00 mm
Beschichtung:	AlCrN PVD
Schneidenzahl:	Z = 5 ≥ ø 25 mm
Drallwinkel:	41,5°
Besonderheiten:	Ungleichteilung, Profilhinterschliffene HPC-Schrappverzahnung
Diameter:	5.00 - 25.00 mm
Coating:	AlCrN PVD
Amount/Teeth:	Z = 5 ≥ ø 25 mm
Helix angle:	41,5°
Special feature:	Unequal division, special HPC roughing geometry

UNItec Pro rough overlength neck		
ISO		
P	P.1	■
	P.2	■
	P.3	■
	P.4	■
	P.5	■
K	K.1	■
	K.2	■
	K.3	■

NEU

Artikelbezeichnung Item Code	Bestell-Nr. Ordering No.	Verfügbarkeit Availability	Abmessungen [mm] Dimensions [mm]							ZEFF [☆]	Schafft Shank
			DC	DCONMS	OAL	APMX	LH	Cx 45°			
UPR05.013.062 Cx Z5 HB	5206037	●	5,00	6,00	62,00	13,00	24,00	0,25	5	HB	
UPR06.013.062 Cx Z5 HB	5206038	●	6,00	6,00	62,00	13,00	25,00	0,30	5	HB	
UPR08.021.068 Cx Z5 HB	5206039	●	8,00	8,00	68,00	21,00	30,00	0,40	5	HB	
UPR10.022.080 Cx Z5 HB	5206040	●	10,00	10,00	80,00	22,00	35,00	0,50	5	HB	
UPR12.026.093 Cx Z5 HB	5206042	●	12,00	12,00	93,00	26,00	45,00	0,60	5	HB	
UPR14.026.099 Cx Z5 HB	5206043	●	14,00	14,00	99,00	26,00	50,00	0,70	5	HB	
UPR16.036.108 Cx Z5 HB	5206044	●	16,00	16,00	108,00	36,00	55,00	0,80	5	HB	
UPR20.041.126 Cx Z5 HB	5206045	●	20,00	20,00	126,00	41,00	70,00	1,00	5	HB	
UPR25.050.150 Cx Z5 HB	5206046	○	25,00	25,00	150,00	50,00	92,00	1,25	5	HB	

Bestellbeispiel Order example: 1 Stück piece 5206037 oder or UPR05.013.062 Cx Z5 HB

Genauere Schnitzwertempfehlung siehe Seite 225

Detailed cutting recommendations, see page 225

* Ausführung ohne Hals

* Version without neck

● Verfügbar ab Lager Available from stock

● Kurzfristig lieferbar Available at short notice

○ Lieferzeit auf Anfrage Delivery time on request

UNItec Pro rough extra long neck

Extra lange Ausführung mit Hals Z5

Execution extra long neck Z5

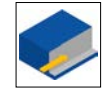
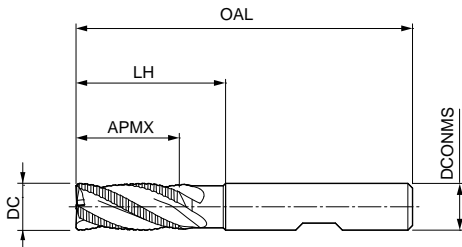

Hard Facts	
Fräserdurchmesser:	6,00 - 20,00 mm
Beschichtung:	AlCrN PVD
Schneidenzahl:	Z = 5 ≥ ø 25 mm
Drallwinkel:	41,5°
Besonderheiten:	Ungleichteilung, Profilhinterschliffene HPC-Schrupverzahnung
Diameter:	6.00 - 20.00 mm
Coating:	AlCrN PVD
Amount/Teeth:	Z = 5 ≥ ø 25 mm
Helix angle:	41,5°
Special feature:	Unequal division, special HPC roughing geometry

UNItec Pro rough extra long neck		
ISO		
P	P.1	■
	P.2	■
	P.3	■
	P.4	■
	P.5	■
K	K.1	■
	K.2	■
	K.3	■

NEU

Artikelbezeichnung Item Code	Bestell-Nr. Ordering No.	Verfügbarkeit Availability	Abmessungen [mm] Dimensions [mm]						ZEFF [☆]	Schaft Shank
			DC	DCONMS	OAL	APMX	LH	Cx 45°		
UPR06.013.080 Cx Z5 HB	5206047	🕒	6,00	6,00	80,00	13,00	42,00	0,30	5	HB
UPR08.021.100 Cx Z5 HB	5206061	🕒	8,00	8,00	100,00	21,00	62,00	0,40	5	HB
UPR10.022.100 Cx Z5 HB	5206065	🕒	10,00	10,00	100,00	22,00	58,00	0,50	5	HB
UPR12.026.120 Cx Z5 HB	5206066	🕒	12,00	12,00	120,00	26,00	73,00	0,60	5	HB
UPR16.036.150 Cx Z5 HB	5206068	🕒	16,00	16,00	150,00	36,00	100,00	0,80	5	HB
UPR20.041.150 Cx Z5 HB	5206070	🕒	20,00	20,00	150,00	41,00	98,00	1,00	5	HB

Bestellbeispiel Order example: 1 Stück piece 5206047 oder or UPR06.013.080 Cx Z5 HB

Genauere Schnittwertempfehlung siehe Seite 225

Detailed cutting recommendations, see page 225

* Ausführung ohne Hals

* Version without neck

Schnittwertempfehlung für Eckfräser, Vorschub und Schnittgeschwindigkeit
Recommended cutting values for corner milling cutters, feed and cutting speed

UNitec Pro rough
short neck Z3/Z4, long neck Z3/4/5

Nutfräsen
Groove milling

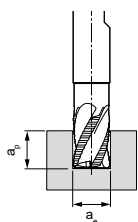

$$a_p = 1 \times D$$

$$a_e = 1 \times D$$

Schruppen
Roughing

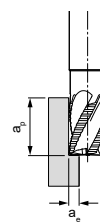

$$a_p = 1,5 \times D$$

$$a_e = 0,25 \times D$$

Werkzeuglänge/ Korrekturfaktor: Tool length/Correction factor:	
Länge Length	f_z & v_c
kurz short	1
lang long	0,9
überlang extra long	0,8
extra lang ultra long	0,6

BZG	Kühlung Cooling			v_c [m/min]	f_z [mm/Zahn] f_z [mm/tooth]							v_c [m/min]	f_z [mm/Zahn] f_z [mm/tooth]							
	MMS/Luft MMS/Air	Trocken Dry	Nass Wet		Fräserdurchmesser [mm] Cutter diameter [mm]		Fräserdurchmesser [mm] Cutter diameter [mm]													
					6	8	10	12	16	20	25		6	8	10	12	16	20	25	
P	P1	●	●	●	160 - 200	0,033	0,042	0,051	0,060	0,075	0,087	0,096	330 - 405	0,056	0,072	0,087	0,101	0,127	0,147	0,163
	P2	●	●	●	125 - 180	0,033	0,042	0,051	0,060	0,075	0,087	0,096	260 - 370	0,056	0,072	0,087	0,101	0,127	0,147	0,163
	P3	●	●	●	100 - 115	0,031	0,040	0,049	0,057	0,071	0,082	0,091	200 - 240	0,053	0,068	0,083	0,096	0,120	0,140	0,155
	P4	●		●	80	0,022	0,028	0,034	0,040	0,050	0,058	0,064	165	0,037	0,048	0,058	0,068	0,085	0,098	0,108
	P5			●	80 - 120	0,032	0,041	0,050	0,058	0,072	0,084	0,093	165 - 245	0,054	0,069	0,084	0,098	0,123	0,142	0,157
M	M1	●		●	55 - 60	0,019	0,025	0,030	0,035	0,044	0,051	0,056	110 - 120	0,033	0,042	0,051	0,059	0,074	0,086	0,095
	M2			●	50 - 55	0,016	0,020	0,025	0,029	0,036	0,042	0,046	105 - 110	0,027	0,035	0,042	0,049	0,061	0,071	0,079
K	K1	●	●	●	215	0,055	0,070	0,085	0,100	0,125	0,144	0,160	440	0,093	0,119	0,145	0,169	0,211	0,245	0,271
	K2	●	●	●	90 - 200	0,047	0,060	0,073	0,085	0,106	0,123	0,136	185 - 405	0,079	0,102	0,123	0,144	0,180	0,208	0,231
	K3	●	●	●	135 - 145	0,038	0,049	0,060	0,070	0,087	0,101	0,112	275 - 295	0,065	0,084	0,101	0,118	0,148	0,171	0,190



* Angegebene Schnittdaten sind als Richtwert zu sehen, welche durch Versuche für jeden Anwendungsfall separat optimiert werden können.
* Recommended cutting data has to be seen as a reference which can be optimised for each application through trials separately.



Eckfräsen - Schlichten
Edge milling - Finishing



Programmübersicht Eckfräsen - Schlichten
 Program overview edge milling - Finishing

Eckfräsen - Schlichten Edge milling finishing		
	UNIttec	UNIttec Pro
		
Zähnezahl Amount teeth	Z6, Z8	Z6
P.1	■	■
P.2	■	■
P.3	■	■
P.4	■	■
P.5	■	■
M.1	□	■
M.2	□	■
K.1	■	■
K.2	■	■
K.3	□	■
N.1	□	
N.2	□	
N.3	□	
H.1		■
H.2		■
H.3		■
H.4		■

UNIttec Finish extra long

Extra lange Ausführung Z6/Z8

Execution extra long Z6/Z8

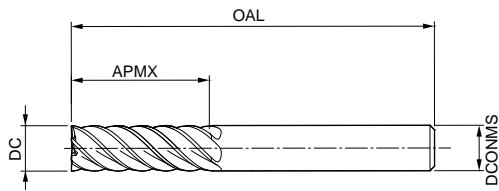

Hard Facts	
Fräserdurchmesser:	4,00 - 25,00 mm
Beschichtung:	TiAIN PVD
Schneidenzahl:	Z = 6 ≤ ø 16 mm Z = 8 ≥ ø 20 mm
Drallwinkel:	45°
Diameter:	4.00 - 25.00 mm
Coating:	TiAIN PVD
Amount/Teeth:	Z = 6 ≤ ø 16 mm Z = 8 ≥ ø 20 mm
Helix angle:	45°

UNIttec Finish extra long		
ISO		
P	P.1	■
	P.2	■
	P.3	■
	P.4	■
	P.5	■
M	M.1	□
	M.2	□
K	K.1	■
	K.2	■
	K.3	□
N	N.1	□
	N.2	□
	N.3	□

Artikelbezeichnung Item Code	Bestell-Nr. Ordering No.	Verfügbarkeit Availability	Abmessungen [mm] Dimensions [mm]					ZEFF [☆]	Schaft Shank
			DC	DCONMS	OAL	APMX	Cx 45°		
U04.016.062 Cx Z6 HA	5162895	○	4,00	6,00	62,00	16,00	0,04	6	HA
U05.018.062 Cx Z6 HA	5162896	●	5,00	6,00	62,00	18,00	0,05	6	HA
U06.018.062 Cx Z6 HA	5162897	●	6,00	6,00	62,00	18,00	0,06	6	HA
U08.024.068 Cx Z6 HA	5162898	●	8,00	8,00	68,00	24,00	0,08	6	HA
U10.030.080 Cx Z6 HA	5162899	●	10,00	10,00	80,00	30,00	0,10	6	HA
U12.036.093 Cx Z6 HA	5162900	○	12,00	12,00	93,00	36,00	0,12	6	HA
U16.048.108 Cx Z6 HA	5162906	●	16,00	16,00	108,00	48,00	0,16	6	HA
U20.060.126 Cx Z8 HA	5162907	●	20,00	20,00	126,00	60,00	0,20	8	HA
U25.095.160 Cx Z8 HA	5162908	●	25,00	25,00	160,00	95,00	0,25	8	HA

Bestellbeispiel Order example: 1 Stück piece 5162895 oder or U04.016.062 Cx Z6 HA

Genauere Schnittwertempfehlung siehe Seite 234

Detailed cutting recommendations, see page 234

- Verfügbar ab Lager Available from stock
- Kurzfristig lieferbar Available at short notice
- Lieferzeit auf Anfrage Delivery time on request

UNItec Pro Finish long neck

Lange Ausführung mit Hals Z6

Execution long neck Z6

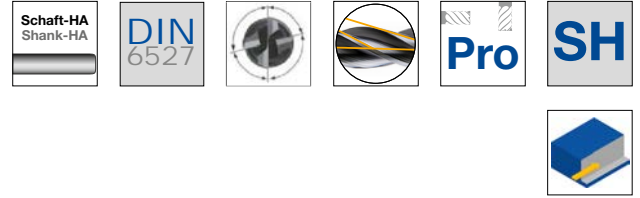
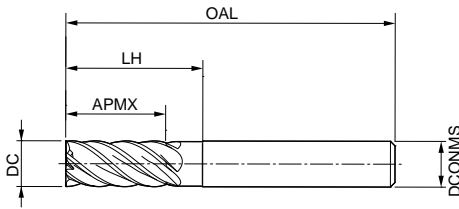

Hard Facts	
Fräserdurchmesser:	6,00 - 20,00 mm
Beschichtung:	AlCrN PVD
Schneidenzahl:	Z = 6
Drallwinkel:	39° - 41°
Besonderheiten:	Ungleichteilung
Diameter:	6.00 - 20.00 mm
Coating:	AlCrN PVD
Amount/Teeth:	Z = 6
Helix angle:	39° - 41°
Special feature:	Unequal division

UNItec Pro Finish long neck		
ISO		
P	P.1	■
	P.2	■
	P.3	■
	P.4	■
	P.5	■
M	M.1	■
	M.2	■
K	K.1	■
	K.2	■
	K.3	■

Artikelbezeichnung Item Code	Bestell-Nr. Ordering No.	Verfügbarkeit Availability	Abmessungen [mm] Dimensions [mm]					ZEFF [☆]	Schaft Shank
			DC	DCONMS	OAL	APMX	LH		
UP06.015.057 SH Z6 HA	5163333	●	6,00	6,00	57,00	15,00	20,00	6	HA
UP08.021.063 SH Z6 HA	5163335	●	8,00	8,00	63,00	21,00	25,00	6	HA
UP10.022.072 SH Z6 HA	5163337	●	10,00	10,00	72,00	22,00	30,00	6	HA
UP12.026.083 SH Z6 HA	5163338	●	12,00	12,00	83,00	26,00	36,00	6	HA
UP16.036.092 SH Z6 HA	5163339	●	16,00	16,00	92,00	36,00	42,00	6	HA
UP20.041.104 SH Z6 HA	5163340	●	20,00	20,00	104,00	41,00	55,00	6	HA

Bestellbeispiel Order example: 1 Stück piece 5163333 oder or UP06.015.057 SH Z6 HA

Genauere Schnittwertempfehlung siehe Seite 235

Detailed cutting recommendations, see page 235

UNItec Pro H Finish neck 2xD

Ausführung 2xD Z6

Execution 2xD Z6

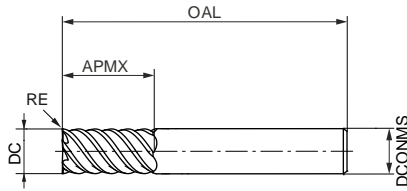

Hard Facts	
Fräserdurchmesser:	4,00 - 20,00 mm
Beschichtung:	AlTiSiN PVD
Schneidezahl:	Z = 6
Drallwinkel:	55°
Besonderheiten:	Ungleichteilung
Diameter:	4.00 - 20.00 mm
Coating:	AlTiSiN PVD
Amount/Teeth:	Z = 6
Helix angle:	55°
Special feature:	Unequal division

UNItec Pro H Finish neck 2xD		
ISO		
P	P.1	<input type="checkbox"/>
	P.2	<input type="checkbox"/>
	P.3	<input type="checkbox"/>
	P.4	<input type="checkbox"/>
	P.5	<input type="checkbox"/>
M	M.1	<input type="checkbox"/>
	M.2	<input type="checkbox"/>
K	K.1	<input type="checkbox"/>
	K.2	<input type="checkbox"/>
	K.3	<input type="checkbox"/>
H	H.1	<input checked="" type="checkbox"/>
	H.2	<input checked="" type="checkbox"/>
	H.3	<input checked="" type="checkbox"/>
	H.4	<input checked="" type="checkbox"/>

Artikelbezeichnung Item Code	Bestell-Nr. Ordering No.	Verfügbarkeit Availability	Abmessungen [mm] Dimensions [mm]					ZEFF [☆]	Schaft Shank
			DC	DCONMS	OAL	APMX	RE		
UPH04.011.057 SH Z6 HA 2D	5163364	●	4,00	6,00	57,00	11,00	-	6	HA
UPH04.011.057 FR0.5 Z6 HA 2D	5163365	●	4,00	6,00	57,00	11,00	0,50	6	HA
UPH05.013.057 SH Z6 HA 2D	5163367	●	5,00	6,00	57,00	13,00	-	6	HA
UPH05.013.057 FR0.5 Z6 HA 2D	5163368	●	5,00	6,00	57,00	13,00	0,50	6	HA
UPH05.013.057 FR1.0 Z6 HA 2D	5163370	●	5,00	6,00	57,00	13,00	1,00	6	HA
UPH06.013.057 SH Z6 HA 2D	5163371	●	6,00	6,00	57,00	13,00	-	6	HA
UPH06.013.057 FR0.5 Z6 HA 2D	5163372	●	6,00	6,00	57,00	13,00	0,50	6	HA
UPH06.013.057 FR1.0 Z6 HA 2D	5163373	●	6,00	6,00	57,00	13,00	1,00	6	HA
UPH08.019.063 SH Z6 HA 2D	5163374	●	8,00	8,00	63,00	19,00	-	6	HA
UPH08.019.063 FR0.5 Z6 HA 2D	5163375	●	8,00	8,00	63,00	19,00	0,50	6	HA
UPH08.019.063 FR1.0 Z6 HA 2D	5163377	●	8,00	8,00	63,00	19,00	1,00	6	HA
UPH10.022.072 SH Z6 HA 2D	5163379	●	10,00	10,00	72,00	22,00	-	6	HA
UPH10.022.072 FR0.5 Z6 HA 2D	5163384	●	10,00	10,00	72,00	22,00	0,50	6	HA
UPH10.022.072 FR1.0 Z6 HA 2D	5163385	●	10,00	10,00	72,00	22,00	1,00	6	HA
UPH12.026.083 SH Z6 HA 2D	5163386	●	12,00	12,00	83,00	26,00	-	6	HA
UPH12.026.083 FR0.5 Z6 HA 2D	5163387	●	12,00	12,00	83,00	26,00	0,50	6	HA
UPH12.026.083 FR1.0 Z6 HA 2D	5163388	●	12,00	12,00	83,00	26,00	1,00	6	HA
UPH16.032.092 SH Z6 HA 2D	5163389	●	16,00	16,00	92,00	32,00	-	6	HA
UPH16.032.092 FR0.5 Z6 HA 2D	5163390	●	16,00	16,00	92,00	32,00	0,50	6	HA
UPH16.032.092 FR1.0 Z6 HA 2D	5163391	●	16,00	16,00	92,00	32,00	1,00	6	HA
UPH16.032.092 FR2.0 Z6 HA 2D	5163392	●	16,00	16,00	92,00	32,00	2,00	6	HA
UPH20.038.104 SH Z6 HA 2D	5163393	○	20,00	20,00	104,00	38,00	-	6	HA
UPH20.038.104 FR1.0 Z6 HA 2D	5163394	○	20,00	20,00	104,00	38,00	1,00	6	HA
UPH20.038.104 FR2.0 Z6 HA 2D	5163402	○	20,00	20,00	104,00	38,00	2,00	6	HA

Bestellbeispiel Order example: 1 Stück piece 5163364 oder or UPH04.011.057 SH Z6 HA 2D

Genauere Schnitwertempfehlung siehe Seite 234

Detailed cutting recommendations, see page 234

- Verfügbar ab Lager Available from stock
- Kurzfristig lieferbar Available at short notice
- Lieferzeit auf Anfrage Delivery time on request

UNItec Pro H Finish neck 3xD

Ausführung 3xD scharf mit Eckenradius Z6

Execution 3xD sharp with corner radius Z6

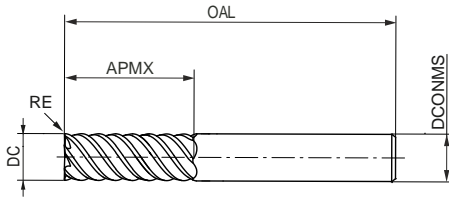

Hard Facts	
Fräserdurchmesser:	4,00 - 20,00 mm
Beschichtung:	AlTiSiN PVD
Schneidenzahl:	Z = 6
Drallwinkel:	55°
Besonderheiten:	Ungleichteilung
Diameter:	4.00 - 20.00 mm
Coating:	AlTiSiN PVD
Amount/Teeth:	Z = 6
Helix angle:	55°
Special feature:	Unequal division

UNItec Pro H Finish neck 3xD		
ISO		
P	P.1	<input type="checkbox"/>
	P.2	<input type="checkbox"/>
	P.3	<input type="checkbox"/>
	P.4	<input type="checkbox"/>
	P.5	<input type="checkbox"/>
M	M.1	<input type="checkbox"/>
	M.2	<input type="checkbox"/>
K	K.1	<input type="checkbox"/>
	K.2	<input type="checkbox"/>
	K.3	<input type="checkbox"/>
H	H.1	<input checked="" type="checkbox"/>
	H.2	<input checked="" type="checkbox"/>
	H.3	<input checked="" type="checkbox"/>
	H.4	<input checked="" type="checkbox"/>

Artikelbezeichnung Item Code	Bestell-Nr. Ordering No.	Verfügbarkeit Availability	Abmessungen [mm] Dimensions [mm]					ZEFF [⊙]	Schaft Shank
			DC	DCONMS	OAL	APMX	RE		
UPH04.016.062 SH Z6 HA 3D	5163403	●	4,00	6,00	62,00	16,00	-	6	HA
UPH04.016.062 FR0.5 Z6 HA 3D	5163404	●	4,00	6,00	62,00	16,00	0,50	6	HA
UPH05.017.062 SH Z6 HA 3D	5163405	●	5,00	6,00	62,00	17,00	-	6	HA
UPH05.017.062 FR0.5 Z6 HA 3D	5163406	●	5,00	6,00	62,00	17,00	0,50	6	HA
UPH05.017.062 FR1.0 Z6 HA 3D	5163407	●	5,00	6,00	62,00	17,00	1,00	6	HA
UPH06.018.062 SH Z6 HA 3D	5163408	●	6,00	6,00	62,00	18,00	-	6	HA
UPH06.018.062 FR0.5 Z6 HA 3D	5163409	●	6,00	6,00	62,00	18,00	0,50	6	HA
UPH06.018.062 FR1.0 Z6 HA 3D	5163410	●	6,00	6,00	62,00	18,00	1,00	6	HA
UPH08.024.068 SH Z6 HA 3D	5163412	●	8,00	8,00	68,00	24,00	-	6	HA
UPH08.024.068 FR0.5 Z6 HA 3D	5163413	●	8,00	8,00	68,00	24,00	0,50	6	HA
UPH08.024.068 FR1.0 Z6 HA 3D	5163414	●	8,00	8,00	68,00	24,00	1,00	6	HA
UPH10.030.080 SH Z6 HA 3D	5163416	●	10,00	10,00	80,00	30,00	-	6	HA
UPH10.030.080 FR0.5 Z6 HA 3D	5163417	●	10,00	10,00	80,00	30,00	0,50	6	HA
UPH10.030.080 FR1.0 Z6 HA 3D	5163418	●	10,00	10,00	80,00	30,00	1,00	6	HA
UPH12.036.093 SH Z6 HA 3D	5163419	●	12,00	12,00	93,00	36,00	-	6	HA
UPH12.036.093 FR0.5 Z6 HA 3D	5163420	●	12,00	12,00	93,00	36,00	0,50	6	HA
UPH12.036.093 FR1.0 Z6 HA 3D	5163421	●	12,00	12,00	93,00	36,00	1,00	6	HA
UPH16.048.108 SH Z6 HA 3D	5163422	●	16,00	16,00	108,00	48,00	-	6	HA
UPH16.048.108 FR0.5 Z6 HA 3D	5163423	●	16,00	16,00	108,00	48,00	0,50	6	HA
UPH16.048.108 FR1.0 Z6 HA 3D	5163424	●	16,00	16,00	108,00	48,00	1,00	6	HA
UPH16.048.108 FR2.0 Z6 HA 3D	5163425	●	16,00	16,00	108,00	48,00	2,00	6	HA
UPH20.060.126 SH Z6 HA 3D	5163426	○	20,00	20,00	126,00	60,00	-	6	HA
UPH20.060.126 FR1.0 Z6 HA 3D	5163427	○	20,00	20,00	126,00	60,00	1,00	6	HA
UPH20.060.126 FR2.0 Z6 HA 3D	5163428	○	20,00	20,00	126,00	60,00	2,00	6	HA

Bestellbeispiel Order example: 1 Stück piece 5163403 oder or UPH04.016.062 SH Z6 HA 3D

Genauere Schnittwertempfehlung siehe Seite 234

Detailed cutting recommendations, see page 234

UNItec Pro H extra long neck

Extra lange Ausführung mit Eckenradius Z6
Execution extra long with corner radius Z6

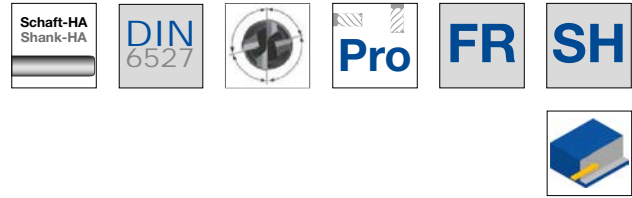
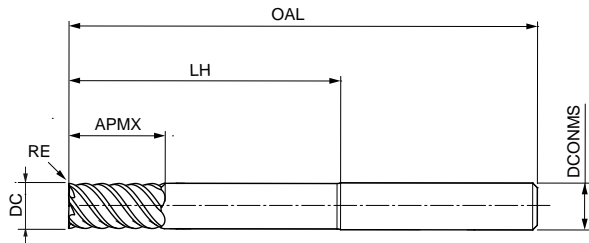

Hard Facts	
Fräserdurchmesser:	6,00 - 20,00 mm
Beschichtung:	AlTiSiN PVD
Schneidenzahl:	Z = 6
Drallwinkel:	42°
Besonderheiten:	Ungleichteilung
Diameter:	6.00 - 20.00 mm
Coating:	AlTiSiN PVD
Amount/Teeth:	Z = 6
Helix angle:	42°
Special feature:	Unequal division

UNItec Pro H Finish neck 3xD		
ISO		
P	P.1	<input type="checkbox"/>
	P.2	<input type="checkbox"/>
	P.3	<input type="checkbox"/>
	P.4	<input type="checkbox"/>
	P.5	<input type="checkbox"/>
M	M.1	<input type="checkbox"/>
	M.2	<input type="checkbox"/>
K	K.1	<input type="checkbox"/>
	K.2	<input type="checkbox"/>
	K.3	<input type="checkbox"/>
H	H.1	<input checked="" type="checkbox"/>
	H.2	<input checked="" type="checkbox"/>
	H.3	<input checked="" type="checkbox"/>
	H.4	<input checked="" type="checkbox"/>

Artikelbezeichnung Item Code	Bestell-Nr. Ordering No.	Verfügbarkeit Availability	Abmessungen [mm] Dimensions [mm]						ZEFF [☆]	Schaft Shank
			DC	DCONMS	OAL	APMX	LH	RE		
UPH06.013.080 SH Z6 HA	5163430	○	6,00	6,00	80,00	13,00	42,00	-	6	HA
UPH06.013.080 FR0.5 Z6 HA	5163431	○	6,00	6,00	80,00	13,00	42,00	0,50	6	HA
UPH06.013.080 FR1.0 Z6 HA	5163432	○	6,00	6,00	80,00	13,00	42,00	1,00	6	HA
UPH08.021.100 SH Z6 HA	5163433	○	8,00	8,00	100,00	21,00	62,00	-	6	HA
UPH08.021.100 FR0.5 Z6 HA	5163435	○	8,00	8,00	100,00	21,00	62,00	0,50	6	HA
UPH08.021.100 FR1.0 Z6 HA	5163436	○	8,00	8,00	100,00	21,00	62,00	1,00	6	HA
UPH10.022.100 SH Z6 HA	5163437	○	10,00	10,00	100,00	22,00	58,00	-	6	HA
UPH10.022.100 FR0.5 Z6 HA	5163438	○	10,00	10,00	100,00	22,00	58,00	0,50	6	HA
UPH10.022.100 FR1.0 Z6 HA	5163439	○	10,00	10,00	100,00	22,00	58,00	1,00	6	HA
UPH12.026.120 SH Z6 HA	5163440	○	12,00	12,00	120,00	26,00	73,00	-	6	HA
UPH12.026.120 FR0.5 Z6 HA	5163441	○	12,00	12,00	120,00	26,00	73,00	0,50	6	HA
UPH12.026.120 FR1.0 Z6 HA	5163443	○	12,00	12,00	120,00	26,00	73,00	1,00	6	HA
UPH16.036.150 SH Z6 HA	5163444	○	16,00	16,00	150,00	36,00	100,00	-	6	HA
UPH16.036.150 FR0.5 Z6 HA	5163445	○	16,00	16,00	150,00	36,00	100,00	0,50	6	HA
UPH16.036.150 FR1.0 Z6 HA	5163446	○	16,00	16,00	150,00	36,00	100,00	1,00	6	HA
UPH16.036.150 FR2.0 Z6 HA	5163447	○	16,00	16,00	150,00	36,00	100,00	2,00	6	HA
UPH20.041.150 SH Z6 HA	5163458	○	20,00	20,00	150,00	41,00	98,00	-	6	HA
UPH20.041.150 FR1.0 Z6 HA	5163460	○	20,00	20,00	150,00	41,00	98,00	1,00	6	HA
UPH20.041.150 FR2.0 Z6 HA	5163462	○	20,00	20,00	150,00	41,00	98,00	2,00	6	HA

Bestellbeispiel Order example: 1 Stück piece 5163430 oder or UPH06.013.080 SH Z6 HA
Genauere Schnittwertempfehlung siehe Seite 234
Detailed cutting recommendations, see page 234

- Verfügbar ab Lager Available from stock
- Kurzfristig lieferbar Available at short notice
- Lieferzeit auf Anfrage Delivery time on request

Schnittwertempfehlung für Eckfräser, Vorschub und Schnittgeschwindigkeit
 Recommended cutting values for corner milling cutters, feed and cutting speed

Schichten
 Finishing

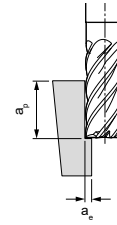

$a_p = 1,5 \times D$
 $a_e = 0,1 \times D$

UNItec Finish extra long Z6/Z8

BZG		Kühlung Cooling			v_c [m/min]	f_z [mm/Zahn] f_z [mm/tooth]							
		MMS/Luft MMS/Air	Trocken Dry	Nass Wet		Fräserdurchmesser [mm] Cutter diameter [mm]							
						4	6	8	10	12	16	20	25
P	P1	●	●	●	340 - 415	0,050	0,070	0,091	0,110	0,128	0,160	0,186	0,206
	P2	●	●	●	265 - 380	0,050	0,070	0,091	0,110	0,128	0,160	0,186	0,206
	P3	●	●	●	210 - 245	0,047	0,067	0,086	0,104	0,122	0,152	0,177	0,196
	P4	●		●	170	0,033	0,047	0,060	0,073	0,085	0,107	0,124	0,137
	P5			●	170 - 255	0,048	0,068	0,088	0,106	0,124	0,155	0,180	0,199
M	M1	●		●	115 - 125	0,029	0,041	0,053	0,064	0,075	0,094	0,108	0,120
	M2			●	105 - 115	0,024	0,034	0,044	0,053	0,062	0,077	0,090	0,099
K	K1	●	●	●	455	0,083	0,117	0,151	0,183	0,214	0,267	0,310	0,343
	K2	●	●	●	190 - 415	0,070	0,100	0,128	0,156	0,182	0,227	0,263	0,292
	K3	●	●	●	285 - 300	0,058	0,082	0,106	0,128	0,149	0,187	0,217	0,240

Schichten
 Finishing

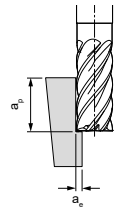

Eintauchwinkel
 Plunge angle
 $0,5^\circ - 1,0^\circ$

**UNItec Pro H Finish neck 2xD SH/FR Z6,
 UNItec Pro H Finish neck 3xD SH/FR Z6,
 UNItec Pro H Finish extra long neck SH/FR Z6**

BZG		Kühlung Cooling			a_p [mm]	a_e [mm]	v_c [m/min]	f_z [mm/Zahn] f_z [mm/tooth]									
		Trocken Dry	Luft/MMS MMS/Air	Nass Wet				Fräserdurchmesser [mm] Cutter diameter [mm]									
								4	5	6	8	10	12	14	16	18	20
P	P1	●	●	●	1xD	0,02xD	180 - 220	0,025	0,030	0,040	0,050	0,065	0,075	0,090	0,105	0,118	0,131
	P2	●	●	●	1xD	0,02xD	160 - 200	0,025	0,030	0,040	0,050	0,065	0,075	0,090	0,105	0,118	0,131
	P3	●	●	●	1xD	0,02xD	140 - 200	0,025	0,030	0,040	0,050	0,065	0,075	0,090	0,105	0,118	0,131
	P4		●	●	1xD	0,02xD	140 - 160	0,021	0,026	0,034	0,043	0,055	0,064	0,077	0,089	0,100	0,111
	P5		●	●	1xD	0,02xD	140 - 170	0,021	0,026	0,034	0,043	0,055	0,064	0,077	0,089	0,100	0,111
M	M1			●	1xD	0,018xD	110 - 130	0,023	0,027	0,036	0,045	0,059	0,068	0,081	0,095	0,106	0,118
	M2			●	1xD	0,015xD	90 - 130	0,021	0,026	0,034	0,043	0,055	0,064	0,077	0,089	0,100	0,111
K	K1	●	●	●	1xD	0,02xD	200 - 220	0,025	0,030	0,040	0,050	0,065	0,075	0,090	0,105	0,118	0,131
	K2	●	●	●	1xD	0,02xD	170 - 200	0,024	0,029	0,038	0,048	0,062	0,071	0,086	0,100	0,112	0,124
	K3	●	●	●	1xD	0,02xD	180 - 220	0,025	0,030	0,040	0,050	0,065	0,075	0,090	0,105	0,118	0,131
H	H1	●	●		1xD	0,015xD	90 - 130	0,021	0,026	0,034	0,043	0,055	0,064	0,077	0,089	0,100	0,111
	H2		●		1xD	0,008xD	80 - 100	0,015	0,018	0,024	0,030	0,039	0,045	0,054	0,063	0,071	0,079
	H3		●		1xD	0,006xD	60 - 90	0,013	0,015	0,020	0,025	0,033	0,038	0,045	0,053	0,059	0,066
	H4	●	●		1xD	0,008xD	80 - 100	0,015	0,018	0,024	0,030	0,039	0,045	0,054	0,063	0,071	0,079

Schnittwertempfehlung für Eckfräser, Vorschub und Schnittgeschwindigkeit
Recommended cutting values for corner milling cutters, feed and cutting speed

Schlichten
Finishing

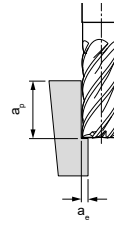

$$a_p = 1,5 \times D$$

$$a_e = 0,1 \times D$$

UNItec Pro Finish long neck Z6

BZG		Kühlung Cooling			v_c [m/min]	f_z [mm/Zahn] f_z [mm/tooth]							
		MMS/Luft MMS/Air	Trocken Dry	Nass Wet		Fräserdurchmesser [mm] Cutter diameter [mm]							
						2	4	6	8	10	12	16	20
P	P1	●	●	●	485 - 595	0,062	0,035	0,062	0,088	0,113	0,137	0,160	0,257
	P2	●	●	●	380 - 540	0,062	0,035	0,062	0,088	0,113	0,137	0,160	0,257
	P3	●	●	●	295 - 350	0,059	0,033	0,059	0,084	0,108	0,131	0,152	0,244
	P4	●		●	245	0,041	0,023	0,041	0,059	0,076	0,092	0,107	0,172
	P5			●	245 - 360	0,060	0,034	0,060	0,085	0,110	0,133	0,155	0,249
M	M1	●		●	160 - 180	0,036	0,020	0,036	0,051	0,066	0,080	0,093	0,150
	M2			●	150 - 160	0,030	0,017	0,030	0,043	0,055	0,066	0,077	0,124
K	K1	●	●	●	650	0,103	0,058	0,103	0,147	0,189	0,229	0,267	0,429
	K2	●	●	●	270 - 595	0,088	0,050	0,088	0,125	0,161	0,195	0,227	0,365
	K3	●	●	●	405 - 430	0,072	0,041	0,072	0,103	0,132	0,160	0,187	0,300

* Angegebene Schnittdaten sind als Richtwert zu sehen, welche durch Versuche für jeden Anwendungsfall separat optimiert werden können.
* Recommended cutting data has to be seen as a reference which can be optimised for each application through trials separately.



boehlerit

Trochoidal Fräsen
Trochoidal milling



Programmübersicht Trochoidal Fräsen
Program overview trochoidal milling

Trochoidal Fräsen Trochoidal milling	
TROCHotec	
	
Zähnezahl Amount teeth	Z5
P.1	■
P.2	■
P.3	■
P.4	■
P.5	■
P.6	■
M.1	■
M.2	■
K.1	■
K.2	■
K.3	■
S.1	■
S.2	■
S.3	■
S.4	■
H.1	■
H.2	■
H.3	□
H.4	□

TROCHotec Universal 3xD neck

Ausführung 3xD mit Hals Z5

Execution 3xD neck Z5

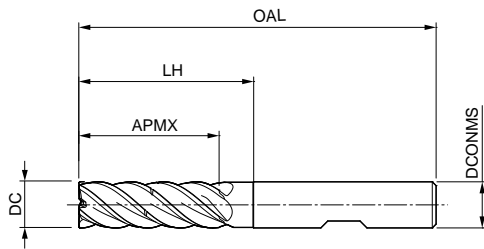

Hard Facts	
Fräserdurchmesser:	4,00 - 25,00 mm
Beschichtung:	AlCrN PVD
Schneidenzahl:	Z = 5
Drallwinkel:	41° - 42°
Wuchtgüte:	Schneidenanteil gewuchtet auf G2.5 nach DIN ISO 1940-G2.5
Besonderheiten:	Ungleichteilung
Diameter:	4.00 - 25.00 mm
Coating:	AlCrN PVD
Amount/Teeth:	Z = 5
Helix angle:	41° - 42°
Balance:	Heaved to G2.5 acc. DIN ISO 1940-G2.5
Special feature:	Unequal division

TROCHotec Universal 3xD neck		
ISO		
P	P.1	■
	P.2	■
	P.3	■
	P.4	■
	P.5	■
M	M.1	□
	M.2	□
K	K.1	■
	K.2	■
	K.3	■

Artikelbezeichnung Item Code	Bestell-Nr. Ordering No.	Verfügbarkeit Availability	Abmessungen [mm] Dimensions [mm]						ZEFF ^o	Schaft Shank
			DC	DCONMS	OAL	APMX	LH	Cx 45°		
T04.016.062 Cx Z5 HB	5163067	●	4,00	6,00	62,00	16,00	23,00	0,08	5	HB
T05.017.062 Cx Z5 HB	5163693	○	5,00	6,00	62,00	17,00	24,00	0,10	5	HB
T06.018.062 Cx Z5 HB	5163082	●	6,00	6,00	62,00	18,00	25,00	0,12	5	HB
T08.024.068 Cx Z5 HB	5163083	●	8,00	8,00	68,00	24,00	30,00	0,16	5	HB
T10.030.080 Cx Z5 HB	5163084	●	10,00	10,00	80,00	30,00	35,00	0,20	5	HB
T12.036.093 Cx Z5 HB	5163085	●	12,00	12,00	93,00	36,00	45,00	0,24	5	HB
T14.042.099 Cx Z5 HB	5163694	○	14,00	14,00	99,00	42,00	50,00	0,28	5	HB
T16.048.108 Cx Z5 HB	5163087	●	16,00	16,00	108,00	48,00	55,00	0,32	5	HB
T18.054.117 Cx Z5 HB	5163695	○	18,00	18,00	117,00	54,00	67,00	0,36	5	HB
T20.060.126 Cx Z5 HB	5163088	●	20,00	20,00	126,00	60,00	70,00	0,40	5	HB
T25.075.150 Cx Z5 HB	5163696	○	25,00	25,00	150,00	75,00	92,00	0,50	5	HB

Bestellbeispiel Order example: 1 Stück piece 5163067 oder or T04.016.062 Cx Z5 HB

Genaue Schnittwertempfehlung siehe Seite 245

Detailed cutting recommendations, see page 245

● Verfügbar ab Lager Available from stock

○ Kurzfristig lieferbar Available at short notice

○ Lieferzeit auf Anfrage Delivery time on request

TROCHotec Universal 5xD

Ausführung 5xD Z5

Execution 5xD Z5

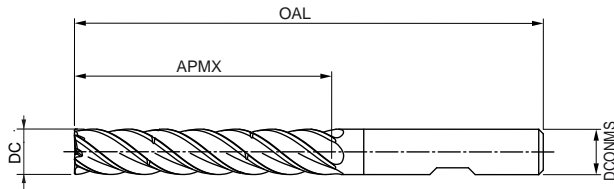

Hard Facts	
Fräserdurchmesser:	8,00 - 25,00 mm
Beschichtung:	AlCrN PVD
Schneidenzahl:	Z = 5
Drallwinkel:	~41°
Wuchtgüte:	Schneidenanteil gewuchtet auf G2.5 nach DIN ISO 1940-G2.5
Besonderheiten:	Ungleichteilung
Diameter:	8.00 - 25.00 mm
Coating:	AlCrN PVD
Amount/Teeth:	Z = 5
Helix angle:	~41°
Balance:	Heaved to G2.5 acc. DIN ISO 1940-G2.5
Special feature:	Unequal division

TROCHotec Universal 5xD neck		
ISO		
P	P.1	■
	P.2	■
	P.3	■
	P.4	■
	P.5	■
M	M.1	□
	M.2	□
K	K.1	■
	K.2	■
	K.3	■

Artikelbezeichnung Item Code	Bestell-Nr. Ordering No.	Verfügbarkeit Availability	Abmessungen [mm] Dimensions [mm]					ZEFF [☆]	Schaft Shank
			DC	DCONMS	OAL	APMX	Cx 45°		
T08.040.081 Cx Z5 HB	5163697	●	8,00	8,00	81,00	40,00	0,16	5	HB
T10.050.096 Cx Z5 HB	5163698	●	10,00	10,00	96,00	50,00	0,20	5	HB
T12.060.112 Cx Z5 HB	5163699	●	12,00	12,00	112,00	60,00	0,24	5	HB
T14.070.122 Cx Z5 HB	5163700	○	14,00	14,00	122,00	70,00	0,28	5	HB
T16.080.136 Cx Z5 HB	5163701	●	16,00	16,00	136,00	80,00	0,32	5	HB
T18.090.147 Cx Z5 HB	5163702	○	18,00	18,00	147,00	90,00	0,36	5	HB
T20.100.160 Cx Z5 HB	5163704	●	20,00	20,00	160,00	100,00	0,40	5	HB
T25.125.195 Cx Z5 HB	5163705	●	25,00	25,00	195,00	125,00	0,50	5	HB

Bestellbeispiel Order example: 1 Stück piece 5163697 oder or T08.040.081 Cx Z5 HB
 Genaue Schnittwertempfehlung siehe Seite 245
 Detailed cutting recommendations, see page 245

TROCHotec PM 3xD neck

Ausführung 3xD mit Hals Z5

Execution 3xD neck Z5

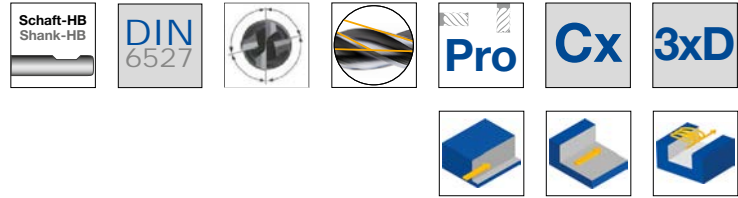
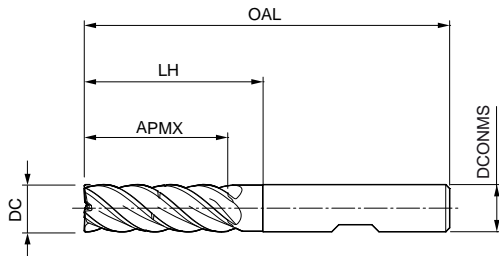

Hard Facts	
Fräserdurchmesser:	4,00 - 25,00 mm
Beschichtung:	AlCrN PVD
Schneidenzahl:	Z = 5
Drallwinkel:	41° - 42°
Wuchtgüte:	Schneidenanteil gewuchtet auf G2.5 nach DIN ISO 1940-G2.5
Besonderheiten:	Ungleichteilung
Diameter:	4.00 - 25.00 mm
Coating:	AlCrN PVD
Amount/Teeth:	Z = 5
Helix angle:	41° - 42°
Balance:	Heaved to G2.5 acc. DIN ISO 1940-G2.5
Special feature:	Unequal division

TROCHotec PM 3xD neck		
ISO		
P	P.1	■
	P.2	■
	P.3	■
	P.4	■
	P.5	■
M	M.1	■
	M.2	■
K	K.1	■
	K.2	■
	K.3	■

Artikelbezeichnung Item Code	Bestell-Nr. Ordering No.	Verfügbarkeit Availability	Abmessungen [mm] Dimensions [mm]						ZEFF [⊙]	Schaft Shank
			DC	DCONMS	OAL	APMX	LH	Cx 45°		
TP04.016.062 Cx Z5 HB	5163089	●	4,00	6,00	62,00	16,00	23,00	0,08	5	HB
TP05.017.062 Cx Z5 HB	5163706	⦿	5,00	6,00	62,00	17,00	24,00	0,10	5	HB
TP06.018.062 Cx Z5 HB	5163090	●	6,00	6,00	62,00	18,00	25,00	0,12	5	HB
TP08.024.068 Cx Z5 HB	5163091	●	8,00	8,00	68,00	24,00	30,00	0,16	5	HB
TP10.030.080 Cx Z5 HB	5163093	●	10,00	10,00	80,00	30,00	35,00	0,20	5	HB
TP12.036.093 Cx Z5 HB	5163095	●	12,00	12,00	93,00	36,00	45,00	0,24	5	HB
TP14.042.099 Cx Z5 HB	5163707	⦿	14,00	14,00	99,00	42,00	50,00	0,28	5	HB
TP16.048.108 Cx Z5 HB	5163096	●	16,00	16,00	108,00	48,00	55,00	0,32	5	HB
TP18.054.117 Cx Z5 HB	5163708	⦿	18,00	18,00	117,00	54,00	67,00	0,36	5	HB
TP20.060.126 Cx Z5 HB	5163097	●	20,00	20,00	126,00	60,00	70,00	0,40	5	HB
TP25.075.150 Cx Z5 HB	5163711	⦿	25,00	25,00	150,00	75,00	92,00	0,50	5	HB

Bestellbeispiel Order example: 1 Stück piece 5163089 oder or TP04.016.062 Cx Z5 HB

Genauere Schnittwertempfehlung siehe Seite 245

Detailed cutting recommendations, see page 245

- Verfügbar ab Lager Available from stock
- ⦿ Kurzfristig lieferbar Available at short notice
- Lieferzeit auf Anfrage Delivery time on request

TROCHotec S 3xD neck

Ausführung 3xD mit Hals Z5

Execution 3xD neck Z5

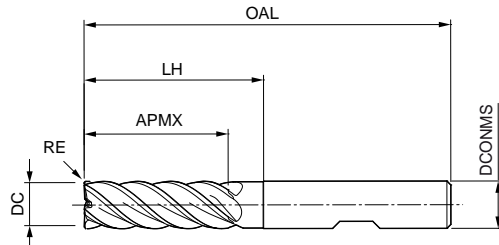

Hard Facts	
Fräserdurchmesser:	5,00 - 25,00 mm
Beschichtung:	TiAlN PVD
Schneidenzahl:	Z = 5
Drallwinkel:	41° - 42°
Wuchtgüte:	Schneidenanteil gewuchtet auf G2.5 nach DIN ISO 1940-G2.5
Besonderheiten:	Ungleichteilung
Diameter:	5.00 - 25.00 mm
Coating:	TiAlN PVD
Amount/Teeth:	Z = 5
Helix angle:	41° - 42°
Balance:	Heaved to G2.5 acc. DIN ISO 1940-G2.5
Special feature:	Unequal division

TROCHotec S 3xD neck		
ISO		
M	M.1	□
	M.2	□
S	S.1	□
	S.2	■
	S.3	■
	S.4	■

Artikelbezeichnung Item Code	Bestell-Nr. Ordering No.	Verfügbarkeit Availability	Abmessungen [mm] Dimensions [mm]							ZEFF [☆]	Schaft Shank
			DC	DCONMS	OAL	APMX	LH	RE			
TS05.017.062 Cr Z5 HB	5163712	○	5,00	6,00	62,00	17,00	24,00	0,10	5	HB	
TS06.018.062 Cr Z5 HB	5163099	●	6,00	6,00	62,00	18,00	25,00	0,10	5	HB	
TS08.024.068 Cr Z5 HB	5163100	●	8,00	8,00	68,00	24,00	30,00	0,20	5	HB	
TS10.030.080 Cr Z5 HB	5163101	●	10,00	10,00	80,00	30,00	35,00	0,20	5	HB	
TS12.036.093 Cr Z5 HB	5163103	●	12,00	12,00	93,00	36,00	45,00	0,30	5	HB	
TS14.042.099 Cr Z5 HB	5163713	○	14,00	14,00	99,00	42,00	50,00	0,30	5	HB	
TS16.048.108 Cr Z5 HB	5163111	●	16,00	16,00	108,00	48,00	55,00	0,30	5	HB	
TS18.054.117 Cr Z5 HB	5163715	○	18,00	18,00	117,00	54,00	67,00	0,30	5	HB	
TS20.060.126 Cr Z5 HB	5163112	●	20,00	20,00	126,00	60,00	70,00	0,30	5	HB	
TS25.075.150 Cr Z5 HB	5163716	○	25,00	25,00	150,00	75,00	92,00	0,40	5	HB	

Bestellbeispiel Order example: 1 Stück piece 5163712 oder or TS05.017.062 Cr Z5 HB

Genauere Schnittwertempfehlung siehe Seite 245

Detailed cutting recommendations, see page 245

TROCHOtec T 3xD neck

Ausführung 3xD mit Hals Z5

Execution 3xD neck Z5

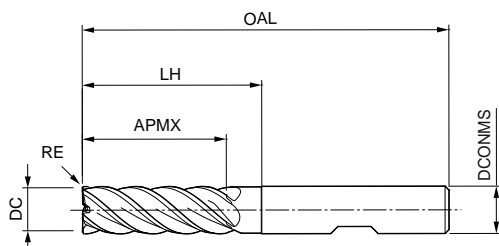

Hard Facts	
Fräserdurchmesser:	5,00 - 25,00 mm
Beschichtung:	TiCCrN PVD
Schneidenzahl:	Z = 5
Drallwinkel:	41° - 42°
Wuchtgüte:	Schneidenanteil gewuchtet auf G2.5 nach DIN ISO 1940-G2.5
Besonderheiten:	Ungleichteilung
Diameter:	5.00 - 25.00 mm
Coating:	TiCCrN PVD
Amount/Teeth:	Z = 5
Helix angle:	41° - 42°
Balance:	Heaved to G2.5 acc. DIN ISO 1940-G2.5
Special feature:	Unequal division

TROCHOtec T 3xD neck		
ISO		
S	S.1	■
	S.2	■
	S.3	□
	S.4	□

Artikelbezeichnung Item Code	Bestell-Nr. Ordering No.	Verfügbarkeit Availability	Abmessungen [mm] Dimensions [mm]						ZEFF [⊙]	Schaft Shank
			DC	DCONMS	OAL	APMX	LH	RE		
TT05.017.062 Cr Z5 HB	5163717	○	5,00	6,00	62,00	17,00	24,00	0,10	5	HB
TT06.018.062 Cr Z5 HB	5163718	○	6,00	6,00	62,00	18,00	25,00	0,10	5	HB
TT08.024.068 Cr Z5 HB	5163719	●	8,00	8,00	68,00	24,00	30,00	0,20	5	HB
TT10.030.080 Cr Z5 HB	5163720	○	10,00	10,00	80,00	30,00	35,00	0,20	5	HB
TT12.036.093 Cr Z5 HB	5163721	●	12,00	12,00	93,00	36,00	45,00	0,30	5	HB
TT14.042.099 Cr Z5 HB	5163722	○	14,00	14,00	99,00	42,00	50,00	0,30	5	HB
TT16.048.108 Cr Z5 HB	5163723	○	16,00	16,00	108,00	48,00	55,00	0,30	5	HB
TT18.054.117 Cr Z5 HB	5163724	○	18,00	18,00	117,00	54,00	67,00	0,30	5	HB
TT20.060.126 Cr Z5 HB	5163725	○	20,00	20,00	126,00	60,00	70,00	0,30	5	HB
TT25.075.150 Cr Z5 HB	5163726	○	25,00	25,00	150,00	75,00	92,00	0,40	5	HB

Bestellbeispiel Order example: 1 Stück piece 5163717 oder or TT05.017.062 Cr Z5 HB
 Genaue Schnittwertempfehlung siehe Seite 245
 Detailed cutting recommendations, see page 245

- Verfügbar ab Lager Available from stock
- ⊙ Kurzfristig lieferbar Available at short notice
- Lieferzeit auf Anfrage Delivery time on request

TROCHotec H 3xD neck

Ausführung 3xD mit Hals Z5

Execution 3xD neck Z5

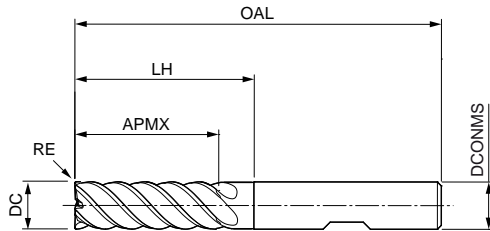

Hard Facts	
Fräserdurchmesser:	5,00 - 25,00 mm
Beschichtung:	AlTiSiN PVD
Schneidenzahl:	Z = 5
Drallwinkel:	41° - 42°
Wuchtgüte:	Schneidenanteil gewuchtet auf G2.5 nach DIN ISO 1940-G2.5
Besonderheiten:	Ungleichteilung
Diameter:	5.00 - 25.00 mm
Coating:	AlTiSiN PVD
Amount/Teeth:	Z = 5
Helix angle:	41° - 42°
Balance:	Heaved to G2.5 acc. DIN ISO 1940-G2.5
Special feature:	Unequal division

TROCHotec H 3xD neck		
ISO		
H	H.1	■
	H.2	■
	H.3	□
	H.4	□

Artikelbezeichnung Item Code	Bestell-Nr. Ordering No.	Verfügbarkeit Availability	Abmessungen [mm] Dimensions [mm]						ZEFF [☆]	Schaft Shank
			DC	DCONMS	OAL	APMX	LH	RE		
TH05.017.062 Cr Z5 HB	5163727	○	5,00	6,00	62,00	17,00	24,00	0,10	5	HB
TH06.018.062 Cr Z5 HB	5163113	●	6,00	6,00	62,00	18,00	25,00	0,10	5	HB
TH08.024.068 Cr Z5 HB	5163114	●	8,00	8,00	68,00	24,00	30,00	0,20	5	HB
TH10.030.080 Cr Z5 HB	5163115	●	10,00	10,00	80,00	30,00	35,00	0,20	5	HB
TH12.036.093 Cr Z5 HB	5163116	●	12,00	12,00	93,00	36,00	45,00	0,30	5	HB
TH14.042.099 Cr Z5 HB	5163728	⊙	14,00	14,00	99,00	42,00	50,00	0,30	5	HB
TH16.048.108 Cr Z5 HB	5163118	●	16,00	16,00	108,00	48,00	55,00	0,30	5	HB
TH18.054.117 Cr Z5 HB	5163551	○	18,00	18,00	117,00	54,00	67,00	0,30	5	HB
TH20.060.126 Cr Z5 HB	5163122	●	20,00	20,00	126,00	60,00	70,00	0,30	5	HB
TH25.075.150 Cr Z5 HB	5163552	○	25,00	25,00	150,00	75,00	92,00	0,40	5	HB

Bestellbeispiel Order example: 1 Stück piece 5163727 oder or TH05.017.062 Cr Z5 HB

Genauere Schnittwertempfehlung siehe Seite 245

Detailed cutting recommendations, see page 245

Schnittwertempfehlung für Eckfräser, Vorschub und Schnittgeschwindigkeit
Recommended cutting values for corner milling cutters, feed and cutting speed

Trochoides Fräsen
Trochoidal milling

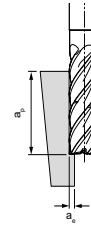

$a_p = \max. 3 \times D$
 $a_e = \text{abhängig vom Werkstoff}$
depending on material

TROCHotec Universal 3xD neck Z5, 5xD Z5
TROCHotec PM 3xD neck Z5

BZG	Kühlung Cooling			v_c [m/min]	f_z [mm/Zahn] in % vom D f_z [mm/tooth] in % of D	a_e [mm] in % vom D in % of D	h_m [mm] in % vom D in % of D	Bearbeitungsbeispiel Machining example
	MMS/Luft MMS/Air	Trocken Dry	Nass Wet					
P	P1	●	●	320 - 520	2,0-2,6	14-18	0,66-0,8	16MnCr5 $\phi = 12$ mm $v_c = 500$ m/min $f_z = 0,28$ mm $a_e = 1,8$ mm $a_p = 32$ mm 42CrMo4 $\phi = 12$ mm $v_c = 375$ m/min $f_z = 0,17$ mm $a_e = 1,2$ mm $a_p = 32$ mm
	P2	●	●	280 - 480	1,8-2,4	10-14	0,58-0,71	
	P3	●	●	210 - 350	1,5-2,2	8-14	0,54-0,65	
	P4	●	●	180 - 260	1,0-1,8	6-12	0,5-0,6	
	P5			160 - 300	1,4-2,0	8-12	0,54-0,62	
M	M1	●	●	130 - 220	0,6-1,0	5-10	0,48-0,6	X5CrNi18-10 $\phi = 12$ mm $v_c = 180$ m/min $f_z = 0,09$ mm $a_e = 1,2$ mm $a_p = 32$ mm
	M2		●	120 - 180	0,6-1,0	5-10	0,46-0,58	
K	K1	●	●	400 - 500	2,0-2,6	15-20	0,64-0,78	
	K2	●	●	180 - 500	1,8-2,4	12-16	0,62-0,7	
	K3	●	●	210 - 360	1,6-2,2	10-16	0,6-0,68	

TROCHotec S 3xD neck Z5, T 3xD neck Z5

BZG	Kühlung Cooling			v_c [m/min]	f_z [mm/Zahn] in % vom D f_z [mm/tooth] in % of D	a_e [mm] in % vom D in % of D	h_m [mm] in % vom D in % of D	Bearbeitungsbeispiel Machining example
	MMS/Luft MMS/Air	Trocken Dry	Nass Wet					
M	M1	●	●	130 - 220	0,6-1,0	5-10	0,48-0,6	X5CrNi18-10 $\phi = 12$ mm $v_c = 180$ m/min $f_z = 0,09$ mm $a_e = 1,2$ mm $a_p = 32$ mm
	M2		●	110 - 180	0,6-1,0	5-10	0,46-0,58	
S	S1		●	110 - 170	0,65-1,3	6-12	0,52-0,6	TiAl6V4 $\phi = 12$ mm $v_c = 140$ m/min $f_z = 0,09$ mm $a_e = 1,2$ mm $a_p = 30$ mm
	S2		●	70 - 150	0,6-1,2	5-10	0,46-0,56	
	S3		●	50 - 120	0,4-1,0	5-10	0,4-0,52	
	S4		●	35 - 90	0,3-0,8	4-8	0,38-0,46	

TROCHotec H 3xD neck Z5

BZG	Kühlung Cooling			v_c [m/min]	f_z [mm/Zahn] in % vom D f_z [mm/tooth] in % of D	a_e [mm] in % vom D in % of D	h_m [mm] in % vom D in % of D	Bearbeitungsbeispiel Machining example
	MMS/Luft MMS/Air	Trocken Dry	Nass Wet					
H	H1	●	●	80 - 140	0,45-0,65	7-12	0,42-0,52	X155CrVMo12-1 $\phi = 12$ mm $v_c = 110$ m/min $f_z = 0,052$ mm $h_m = 0,04$ mm $a_e = 1$ mm
	H2	●	●	60 - 120	0,4-0,52	6-12	0,4-0,5	
	H3	●	●	50 - 100	0,3-0,5	5-10	0,38-0,46	
	H4	●	●	60 - 120	0,35-0,55	6-12	0,4-0,48	

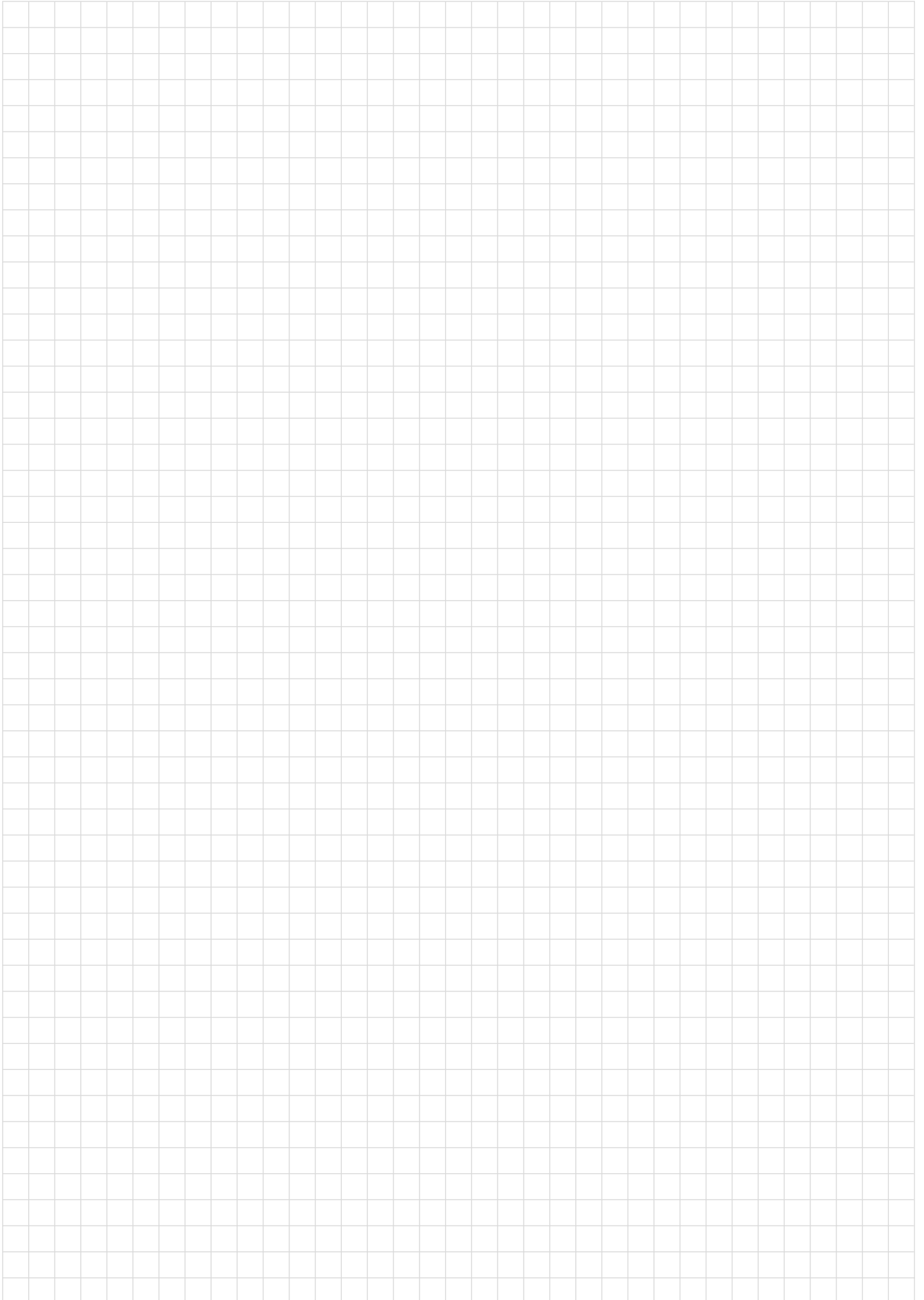

* Angegebene Schnittdaten sind als Richtwert zu sehen, welche durch Versuche für jeden Anwendungsfall separat optimiert werden können.
* Recommended cutting data has to be seen as a reference which can be optimised for each application through trials separately.

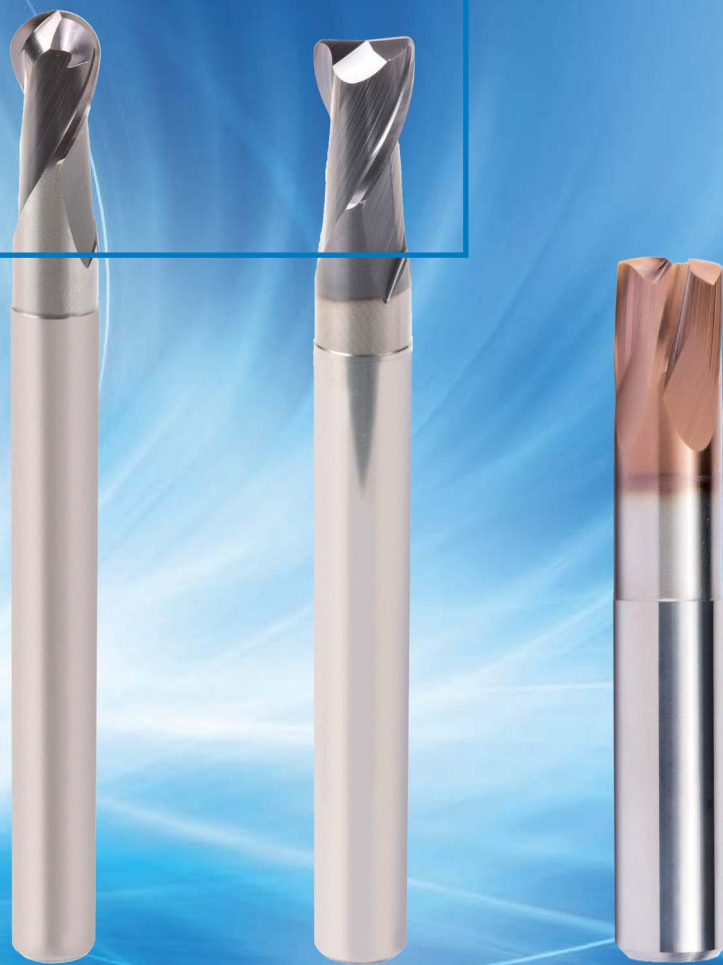

boehlerit

3D - Fräsen Vollhartmetall
3D - Milling solid carbide



3D - Fräsen Vollhartmetall 3D - Milling solid carbide				
	BALLtec	TORROtec SC	FEEDtec	UNItc Pro
				
Zähnezahl Amount teeth	Z2, Z4	Z2	Z4, Z6	Z4, Z5
P.1	■	■	■	■
P.2	■	■	■	■
P.3	■	■	■	■
P.4	■	■	■	■
P.5	■	■	■	■
M.1	□	□		
M.2	□	□		
K.1	□	□	■	■
K.2	□	□	■	■
K.3	□			
N.1	■	■		
N.2	■	■		
N.3	□	□		
N.4	■			
H.1	■	■	■	■
H.2	■	■	■	■
H.3	■	■	■	■
H.4	■	■	■	■

BALLtec SC Universal

Kugelfräser „Form B“ Z2
Ballnose cutter „Form B“ Z2

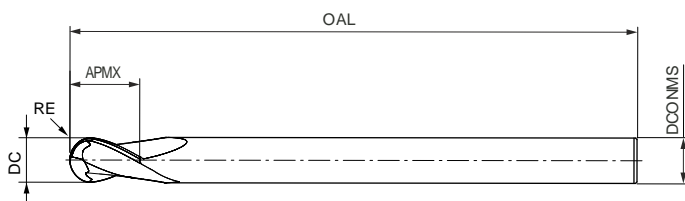

Hard Facts	
Fräserdurchmesser:	6,00 - 10,00 mm
Beschichtung:	AlCrN PVD
Schneidenzahl:	Z = 2
Drallwinkel:	28°
Radiusgenauigkeit:	R = ± 0,005 bis ø 6 mm R = ± 0,01 ab ø 8 mm
Anwendung:	Geeignet zur Bearbeitung von Werkstoffen bis 55 HRC.
Diameter:	6.00 - 10.00 mm
Coating:	AlCrN PVD
Amount/Teeth:	Z = 2
Helix angle:	28°
Tolerance:	R = ± 0.005 until ø 6 mm R = ± 0.01 from ø 8 mm
Application:	Machining of materials up to 55 HRC.

BALLtec SC Universal		
ISO		
P	P.1	■
	P.2	■
	P.3	■
	P.4	■
	P.5	■
M	M.1	□
	M.2	□
K	K.1	□
	K.2	□
	K.3	□
H	H.1	■
	H.2	□

Artikelbezeichnung Item Code	Bestell-Nr. Ordering No.	Verfügbarkeit Availability	Abmessungen [mm] Dimensions [mm]					ZEFF [☆]	Schaff Shank
			DC	DCONMS	OAL	APMX	RE		
BCU006.006.060 FR3.0 Z2 HA B	5164114	●	6,00	6,00	60,00	6,00	3,00	2	HA
BCU008.008.064 FR4.0 Z2 HA B	5164116	●	8,00	8,00	64,00	8,00	4,00	2	HA
BCU010.010.075 FR5.0 Z2 HA B	5164117	●	10,00	10,00	75,00	10,00	5,00	2	HA

Bestellbeispiel Order example: 1 Stück piece 5164114 oder or BCU006.006.060 FR3.0 Z2 HA B
Genauere Schnittwertempfehlung siehe Seite 275
Detailed cutting recommendations, see page 275

- Verfügbar ab Lager Available from stock
- ⦿ Kurzfristig lieferbar Available at short notice
- Lieferzeit auf Anfrage Delivery time on request

BALLtec SC Universal

Kugelfräser mit Hals „Form B“ Z2
Ballnose cutter neck „Form B“ Z2

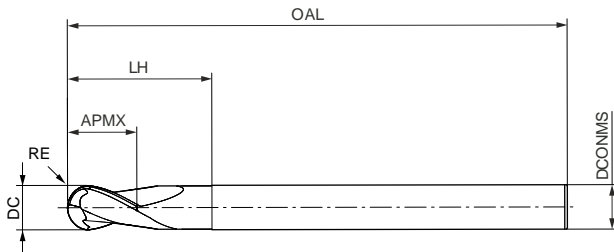

Hard Facts	
Fräserdurchmesser:	0,40 - 6,00 mm
Beschichtung:	AlCrN PVD
Schneidenzahl:	Z = 2
Drallwinkel:	28°
Radiusgenauigkeit:	R = ± 0,005 bis ø 6 mm R = ± 0,01 ab ø 8 mm
Anwendung:	Geeignet zur Bearbeitung von Werkstoffen bis 55 HRC.
Diameter:	0.40 - 6.00 mm
Coating:	AlCrN PVD
Amount/Teeth:	Z = 2
Helix angle:	28°
Tolerance:	R = ± 0.005 until ø 6 mm R = ± 0.01 from ø 8 mm
Application:	Machining of materials up to 55 HRC.

BALLtec SC Universal		
ISO		
P	P.1	■
	P.2	■
	P.3	■
	P.4	■
	P.5	■
M	M.1	□
	M.2	□
K	K.1	□
	K.2	□
	K.3	□
H	H.1	□
	H.2	□

Artikelbezeichnung Item Code	Bestell-Nr. Ordering No.	Verfügbarkeit Availability	Abmessungen [mm] Dimensions [mm]							ZEFF	Schaft Shank
			DC	DCONMS	OAL	APMX	LH	RE			
BCU00.4.00.4.050 FR0.2 Z2 00.7 HA B	5164235	●	0,40	4,00	50,00	0,40	0,75	0,20	2	HA	
BCU00.4.00.4.050 FR0.2 Z2 001 HA B	5164238	●	0,40	4,00	50,00	0,40	1,00	0,20	2	HA	
BCU00.4.00.4.050 FR0.2 Z2 01.5 HA B	5164118	●	0,40	4,00	50,00	0,40	1,50	0,20	2	HA	
BCU00.4.00.4.050 FR0.2 Z2 002 HA B	5164242	●	0,40	4,00	50,00	0,40	2,00	0,20	2	HA	
BCU00.5.00.5.050 FR0.3 Z2 01.5 HA B	5164243	●	0,50	4,00	50,00	0,50	1,50	0,25	2	HA	
BCU00.5.00.5.050 FR0.3 Z2 002 HA B	5164244	●	0,50	4,00	50,00	0,50	2,00	0,25	2	HA	
BCU00.5.00.5.050 FR0.3 Z2 003 HA B	5164119	●	0,50	4,00	50,00	0,50	3,00	0,25	2	HA	
BCU00.5.00.5.050 FR0.3 Z2 004 HA B	5164245	●	0,50	4,00	50,00	0,50	4,00	0,25	2	HA	
BCU00.6.00.6.050 FR0.3 Z2 002 HA B	5164247	●	0,60	4,00	50,00	0,60	2,00	0,30	2	HA	
BCU00.6.00.6.050 FR0.3 Z2 003 HA B	5164120	●	0,60	4,00	50,00	0,60	3,00	0,30	2	HA	
BCU00.6.00.6.050 FR0.3 Z2 004 HA B	5164248	●	0,60	4,00	50,00	0,60	4,00	0,30	2	HA	
BCU00.6.00.6.050 FR0.3 Z2 005 HA B	5164249	●	0,60	4,00	50,00	0,60	5,00	0,30	2	HA	
BCU00.8.00.8.050 FR0.4 Z2 003 HA B	5164121	●	0,80	4,00	50,00	0,80	3,00	0,40	2	HA	
BCU00.8.00.8.050 FR0.4 Z2 004 HA B	5164255	●	0,80	4,00	50,00	0,80	4,00	0,40	2	HA	

Bestellbeispiel Order example: 1 Stück piece 5164235 oder or BCU00.4.00.4.050 FR0.2 Z2 00.7 HA B
Genauere Schnittwertempfehlung siehe Seite 275
Detailed cutting recommendations, see page 275

BALLtec SC Universal

Kugelfräser mit Hals „Form B“ Z2

Ballnose cutter neck „Form B“ Z2

Artikelbezeichnung Item Code	Bestell-Nr. Ordering No.	Verfügbarkeit Availability	Abmessungen [mm] Dimensions [mm]						ZEFF	Schaft Shank
			DC	DCONMS	OAL	APMX	LH	RE		
BCU00.8.00.8.050 FR0.4 Z2 006 HA B	5164264	●	0,80	4,00	50,00	0,80	6,00	0,40	2	HA
BCU001.001.050 FR0.5 Z2 003 HA B	5164122	●	1,00	4,00	50,00	1,00	3,00	0,50	2	HA
BCU001.001.050 FR0.5 Z2 004 HA B	5164265	●	1,00	4,00	50,00	1,00	4,00	0,50	2	HA
BCU001.001.050 FR0.5 Z2 005 HA B	5164123	●	1,00	4,00	50,00	1,00	5,00	0,50	2	HA
BCU001.001.050 FR0.5 Z2 006 HA B	5164267	●	1,00	4,00	50,00	1,00	6,00	0,50	2	HA
BCU001.001.050 FR0.5 Z2 008 HA B	5164290	●	1,00	4,00	50,00	1,00	8,00	0,50	2	HA
BCU001.001.050 FR0.5 Z2 010 HA B	5164292	●	1,00	4,00	50,00	1,00	10,00	0,50	2	HA
BCU01.5.01.5.050 FR0.8 Z2 005 HA B	5164293	●	1,50	4,00	50,00	1,50	5,00	0,75	2	HA
BCU01.5.01.5.050 FR0.8 Z2 006 HA B	5164294	●	1,50	4,00	50,00	1,50	6,00	0,75	2	HA
BCU01.5.01.5.050 FR0.8 Z2 008 HA B	5164295	●	1,50	4,00	50,00	1,50	8,00	0,75	2	HA
BCU01.5.01.5.050 FR0.8 Z2 010 HA B	5164296	●	1,50	4,00	50,00	1,50	10,00	0,75	2	HA
BCU01.5.01.5.050 FR0.8 Z2 012 HA B	5164297	●	1,50	4,00	50,00	1,50	12,00	0,75	2	HA
BCU01.5.01.5.050 FR0.8 Z2 015 HA B	5164298	●	1,50	4,00	50,00	1,50	15,00	0,75	2	HA
BCU002.002.050 FR1.0 Z2 006 HA B	5164124	●	2,00	4,00	50,00	2,00	6,00	1,00	2	HA
BCU002.002.050 FR1.0 Z2 008 HA B	5164299	●	2,00	4,00	50,00	2,00	8,00	1,00	2	HA
BCU002.002.050 FR1.0 Z2 010 HA B	5164300	●	2,00	4,00	50,00	2,00	10,00	1,00	2	HA
BCU002.002.050 FR1.0 Z2 012 HA B	5164301	●	2,00	4,00	50,00	2,00	12,00	1,00	2	HA
BCU002.002.050 FR1.0 Z2 015 HA B	5164302	●	2,00	4,00	50,00	2,00	15,00	1,00	2	HA
BCU002.002.050 FR1.0 Z2 018 HA B	5164303	●	2,00	4,00	50,00	2,00	18,00	1,00	2	HA
BCU002.002.050 FR1.0 Z2 020 HA B	5164304	●	2,00	4,00	50,00	2,00	20,00	1,00	2	HA
BCU02.5.02.5.075 FR1.3 Z2 025 HA B	5164308	●	2,50	4,00	75,00	2,50	25,00	1,25	2	HA
BCU003.003.063 FR1.5 Z2 010 HA B	5164126	●	3,00	6,00	60,00	3,00	10,00	1,50	2	HA
BCU003.003.060 FR1.5 Z2 015 HA B	5164309	●	3,00	6,00	60,00	3,00	15,00	1,50	2	HA
BCU003.003.060 FR1.5 Z2 020 HA B	5164310	●	3,00	6,00	60,00	3,00	20,00	1,50	2	HA
BCU003.003.075 FR1.5 Z2 025 HA B	5164311	●	3,00	6,00	75,00	3,00	25,00	1,50	2	HA
BCU004.004.060 FR2.0 Z2 010 HA B	5164312	●	4,00	6,00	60,00	4,00	10,00	2,00	2	HA
BCU004.004.060 FR2.0 Z2 015 HA B	5164127	●	4,00	6,00	60,00	4,00	15,00	2,00	2	HA
BCU004.004.060 FR2.0 Z2 020 HA B	5164313	●	4,00	6,00	60,00	4,00	20,00	2,00	2	HA
BCU004.004.075 FR2.0 Z2 025 HA B	5164314	●	4,00	6,00	75,00	4,00	25,00	2,00	2	HA
BCU004.004.075 FR2.0 Z2 030 HA B	5164315	●	4,00	6,00	75,00	4,00	30,00	2,00	2	HA
BCU004.004.075 FR2.0 Z2 035 HA B	5164316	●	4,00	6,00	75,00	4,00	35,00	2,00	2	HA
BCU005.005.060 FR2.5 Z2 015 HA B	5164317	●	5,00	6,00	60,00	5,00	15,00	2,50	2	HA
BCU005.005.060 FR2.5 Z2 020 HA B	5164318	●	5,00	6,00	60,00	5,00	20,00	2,50	2	HA
BCU006.006.060 FR3.0 Z2 015 HA B	5164128	●	6,00	6,00	60,00	6,00	15,00	3,00	2	HA
BCU006.006.060 FR3.0 Z2 020 HA B	5164319	●	6,00	6,00	60,00	6,00	20,00	3,00	2	HA
BCU006.006.060 FR3.0 Z2 025 HA B	5164320	●	6,00	6,00	60,00	6,00	25,00	3,00	2	HA
BCU006.006.075 FR3.0 Z2 030 HA B	5164322	●	6,00	6,00	75,00	6,00	30,00	3,00	2	HA
BCU006.006.075 FR3.0 Z2 035 HA B	5164323	●	6,00	6,00	75,00	6,00	35,00	3,00	2	HA

Bestellbeispiel Order example: 1 Stück piece 5164264 oder or BCU00.8.00.8.050 FR0.4 Z2 006 HA B
 Genaue Schnittwertempfehlung siehe Seite 275
 Detailed cutting recommendations, see page 275

- Verfügbar ab Lager Available from stock
- Kurzfristig lieferbar Available at short notice
- Lieferzeit auf Anfrage Delivery time on request

BALLtec SC Universal

Kugelfräser „Form B“ Z4

Ballnose „Form B“ Z4

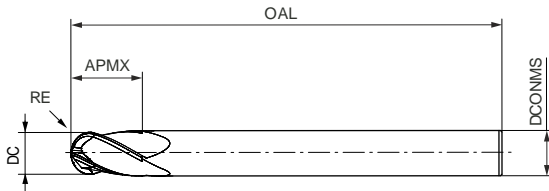

Hard Facts	
Fräserdurchmesser:	6,00 - 10,00 mm
Beschichtung:	AlTiN PVD
Schneidenzahl:	Z = 4
Drallwinkel:	30°
Radiusgenauigkeit:	R = ± 0,005
Anwendung:	Geeignet zur Bearbeitung von Werkstoffen bis 55 HRC.
Diameter:	6.00 - 10.00 mm
Coating:	AlTiN PVD
Amount/Teeth:	Z = 4
Helix angle:	30°
Tolerance:	R = ± 0.005
Application:	Machining of materials up to 55 HRC.

BALLtec SC Universal		
ISO		
P	P.1	■
	P.2	■
	P.3	■
	P.4	■
	P.5	■
M	M.1	□
	M.2	□
K	K.1	□
	K.2	□
	K.3	□
H	H.1	■
	H.2	□

Artikelbezeichnung Item Code	Bestell-Nr. Ordering No.	Verfügbarkeit Availability	Abmessungen [mm] Dimensions [mm]					ZEFF [☆]	Schaft Shank
			DC	DCONMS	OAL	APMX	RE		
BCU006.006.060 FR3.0 Z4 HA B	5164130	●	6,00	6,00	60,00	6,00	3,00	4	HA
BCU008.008.064 FR4.0 Z4 HA B	5164131	●	8,00	8,00	64,00	8,00	4,00	4	HA
BCU010.010.075 FR5.0 Z4 HA B	5164132	●	10,00	10,00	75,00	10,00	5,00	4	HA

Bestellbeispiel Order example: 1 Stück piece 5164130 oder or BCU006.006.060 FR3.0 Z4 HA B

Genauere Schnittwertempfehlung siehe Seite 275

Detailed cutting recommendations, see page 275

BALLtec SC Universal

Kugelfräser mit Hals „Form B“ Z4
Ballnose cutter neck „Form B“ Z4

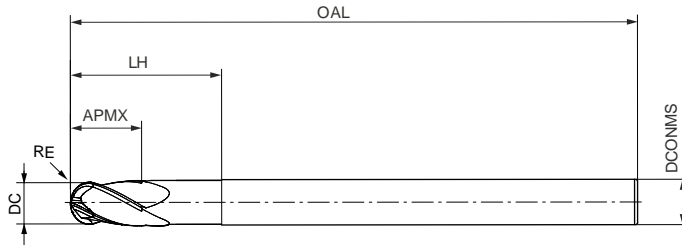

Hard Facts	
Fräserdurchmesser:	3,00 - 6,00 mm
Beschichtung:	AlTiN PVD
Schneidenzahl:	Z = 4
Drallwinkel:	30°
Radiusgenauigkeit:	R = ± 0,005
Anwendung:	Geeignet zur Bearbeitung von Werkstoffen bis 55 HRC.
Diameter:	3.00 - 6.00 mm
Coating:	AlTiN PVD
Amount/Teeth:	Z = 4
Helix angle:	30°
Tolerance:	R = ± 0.005
Application:	Machining of materials up to 55 HRC.

BALLtec SC Universal		
ISO		
P	P.1	■
	P.2	■
	P.3	■
	P.4	■
	P.5	■
M	M.1	□
	M.2	□
K	K.1	□
	K.2	□
	K.3	□
H	H.1	■
	H.2	□

Artikelbezeichnung Item Code	Bestell-Nr. Ordering No.	Verfügbarkeit Availability	Abmessungen [mm] Dimensions [mm]							ZEFF	Schaft Shank
			DC	DCONMS	OAL	APMX	LH	RE			
BCU003.003.060 FR1.5 Z4 010 HA B	5164138	●	3,00	6,00	60,00	3,00	10,00	1,50	4	HA	
BCU004.004.060 FR2.0 Z4 010 HA B	5164139	●	4,00	6,00	60,00	4,00	10,00	2,00	4	HA	
BCU005.005.060 FR2.5 Z4 015 HA B	5164325	⦿	5,00	6,00	60,00	5,00	15,00	2,50	4	HA	
BCU006.006.060 FR3.0 Z4 020 HA B	5164326	⦿	6,00	6,00	60,00	6,00	20,00	3,00	4	HA	

Bestellbeispiel Order example: 1 Stück piece 5164138 oder or BCU003.003.060 FR1.5 Z4 010 HA B
Genauere Schnittwertempfehlung siehe Seite 275
Detailed cutting recommendations, see page 275

- Verfügbar ab Lager Available from stock
- ⦿ Kurzfristig lieferbar Available at short notice
- Lieferzeit auf Anfrage Delivery time on request

BALLtec SC Hardened

Kugelfräser „Form B“ Z2

Ballnose cutter „Form B“ Z2

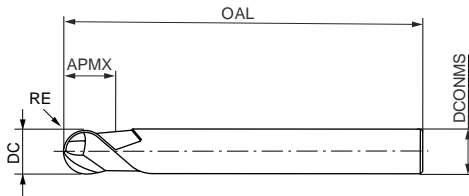

Hard Facts	
Fräserdurchmesser:	6,00 - 10,00 mm
Beschichtung:	TiSiN PVD
Schneidenzahl:	Z = 2
Drallwinkel:	30°
Radiusgenauigkeit:	R = ±0,005 wenn d1 ≤ 6 mm R = ±0,01 wenn d1 > 6 mm
Anwendung:	Geeignet zur Bearbeitung von Werkstoffen bis 66 HRC.
Diameter:	6.00 - 10.00 mm
Coating:	TiSiN PVD
Amount/Teeth:	Z = 2
Helix angle:	30°
Tolerance:	R = ±0.005 if d1 ≤ 6 mm R = ±0.01 if d1 > 6 mm
Application:	Machining of materials up to 66 HRC.

BALLtec SC Hardened		
ISO		
P	P.1	□
	P.2	□
	P.3	□
	P.4	□
	P.5	□
K	K.1	□
	K.2	□
	K.3	□
H	H.1	■
	H.2	■
	H.3	■
	H.4	■

Artikelbezeichnung Item Code	Bestell-Nr. Ordering No.	Verfügbarkeit Availability	Abmessungen [mm] Dimensions [mm]					ZEFF [⊙]	Schaft Shank
			DC	DCONMS	OAL	APMX	RE		
BCH006.06.9.060 FR3.0 Z2 HA B	5169923	●	6,00	6,00	60	6,9	3	2	HA
BCH008.09.2.064 FR4.0 Z2 HA B	5169924	●	8,00	8,00	64	9,2	4	2	HA
BCH010.011.075 FR5.0 Z2 HA B	5169925	●	10,00	10,00	75	11,5	5	2	HA

Bestellbeispiel Order example: 1 Stück piece 5169923 oder or BCH006.06.9.060 FR3.0 Z2 HA B

Genauere Schnittwertempfehlung siehe Seite 276

Detailed cutting recommendations, see page 276

BALLtec SC Hardened
Kugelfräser mit Hals „Form B“ Z2
Ballnose cutter neck „Form B“ Z2

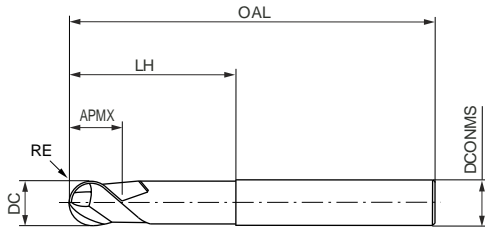

Hard Facts	
Fräserdurchmesser:	0,40 - 6,00 mm
Beschichtung:	TiSiN PVD
Schneidenzahl:	Z = 2
Drallwinkel:	30°
Radiusgenauigkeit:	R = ±0,005 wenn d1 ≤ 6 mm R = ±0,01 wenn d1 > 6 mm
Anwendung:	Geeignet zur Bearbeitung von Werkstoffen bis 66 HRC.
Diameter:	0.40 - 6.00 mm
Coating:	TiSiN PVD
Amount/Teeth:	Z = 2
Helix angle:	30°
Tolerance:	R = ±0.005 if d1 ≤ 6 mm R = ±0.01 if d1 > 6 mm
Application:	Machining of materials up to 66 HRC.

BALLtec SC Hardened		
ISO		
P	P.1	<input type="checkbox"/>
	P.2	<input type="checkbox"/>
	P.3	<input type="checkbox"/>
	P.4	<input type="checkbox"/>
	P.5	<input type="checkbox"/>
K	K.1	<input type="checkbox"/>
	K.2	<input type="checkbox"/>
	K.3	<input type="checkbox"/>
H	H.1	<input checked="" type="checkbox"/>
	H.2	<input checked="" type="checkbox"/>
	H.3	<input checked="" type="checkbox"/>
	H.4	<input checked="" type="checkbox"/>

Artikelbezeichnung Item Code	Bestell-Nr. Ordering No.	Verfügbarkeit Availability	Abmessungen [mm] Dimensions [mm]						ZEFL [®]	Schaft Shank
			DC	DCONMS	OAL	APMX	LH	RE		
BCH00.4.00.5.050 FR0.2 Z2 00.7 HA B	5170025	○	0,40	4,00	50	0,5	0,75	0,2	2	HA
BCH00.4.00.5.050 FR0.2 Z2 001 HA B	5170026	○	0,40	4,00	50	0,5	1	0,2	2	HA
BCH00.4.00.5.050 FR0.2 Z2 01.5 HA B	5170027	○	0,40	4,00	50	0,5	1,5	0,2	2	HA
BCH00.4.00.5.050 FR0.2 Z2 002 HA B	5170028	○	0,40	4,00	50	0,5	2	0,2	2	HA
BCH00.5.00.6.050 FR0.25 Z2 01.5 HA B	5170030	●	0,50	4,00	50	0,6	1,5	0,25	2	HA
BCH00.5.00.6.050 FR0.25 Z2 002 HA B	5170031	●	0,50	4,00	50	0,6	2	0,25	2	HA
BCH00.5.00.6.050 FR0.25 Z2 003 HA B	5170032	●	0,50	4,00	50	0,6	3	0,25	2	HA
BCH00.5.00.6.050 FR0.25 Z2 004 HA B	5170033	●	0,50	4,00	50	0,6	4	0,25	2	HA
BCH00.6.00.7.050 FR0.3 Z2 002 HA B	5170041	●	0,60	4,00	50	0,7	2	0,3	2	HA
BCH00.6.00.7.050 FR0.3 Z2 003 HA B	5170042	●	0,60	4,00	50	0,7	3	0,3	2	HA
BCH00.6.00.7.050 FR0.3 Z2 004 HA B	5170043	●	0,60	4,00	50	0,7	4	0,3	2	HA
BCH00.6.00.7.050 FR0.3 Z2 005 HA B	5170045	●	0,60	4,00	50	0,7	5	0,3	2	HA
BCH00.8.00.9.050 FR0.4 Z2 003 HA B	5170048	●	0,80	4,00	50	0,9	3	0,4	2	HA
BCH00.8.00.9.050 FR0.4 Z2 004 HA B	5170049	●	0,80	4,00	50	0,9	4	0,4	2	HA
BCH00.8.00.9.050 FR0.4 Z2 006 HA B	5170050	●	0,80	4,00	50	0,9	6	0,4	2	HA

Bestellbeispiel Order example: 1 Stück piece 5170025 oder or BCH00.4.00.5.050 FR0.2 Z2 00.7 HA B
Genauere Schnittwertempfehlung siehe Seite 276
Detailed cutting recommendations, see page 276

- Verfügbar ab Lager Available from stock
- Kurzfristig lieferbar Available at short notice
- Lieferzeit auf Anfrage Delivery time on request

BALLtec SC Hardened

Kugelfräser mit Hals „Form B“ Z2

Ballnose cutter neck „Form B“ Z2

Artikelbezeichnung Item Code	Bestell-Nr. Ordering No.	Verfügbarkeit Availability	Abmessungen [mm] Dimensions [mm]						NEFFO	Schaft Shank
			DC	DCONMS	OAL	APMX	LH	RE		
BCH001.01.2.050 FR0.5 Z2 003 HA B	5170051	☉	1,00	4,00	50	1,2	3	0,5	2	HA
BCH001.01.2.050 FR0.5 Z2 004 HA B	5170057	☉	1,00	4,00	50	1,2	4	0,5	2	HA
BCH001.01.2.050 FR0.5 Z2 005 HA B	5170058	☉	1,00	4,00	50	1,2	5	0,5	2	HA
BCH001.01.2.050 FR0.5 Z2 006 HA B	5170059	☉	1,00	4,00	50	1,2	6	0,50	2	HA
BCH001.01.2.050 FR0.5 Z2 008 HA B	5170061	☉	1,00	4,00	50	1,2	8	0,50	2	HA
BCH001.01.2.050 FR0.5 Z2 010 HA B	5170069	☉	1,00	4,00	50	1,2	10	0,50	2	HA
BCH01.5.01.7.050 FR0.75 Z2 005 HA B	5170070	☉	1,50	4,00	50	1,7	5	0,75	2	HA
BCH01.5.01.7.050 FR0.75 Z2 006 HA B	5170071	☉	1,50	4,00	50	1,7	6	0,75	2	HA
BCH01.5.01.7.050 FR0.75 Z2 008 HA B	5170072	☉	1,50	4,00	50	1,7	8	0,75	2	HA
BCH01.5.01.7.050 FR0.75 Z2 010 HA B	5170073	☉	1,50	4,00	50	1,7	10	0,75	2	HA
BCH01.5.01.7.050 FR0.75 Z2 012 HA B	5170074	☉	1,50	4,00	50	1,7	12	0,75	2	HA
BCH01.5.01.7.050 FR0.75 Z2 015 HA B	5170075	☉	1,50	4,00	50	1,7	15	0,75	2	HA
BCH002.02.3.050 FR1.0 Z2 006 HA B	5170076	☉	2,00	4,00	50	2,3	6	1,00	2	HA
BCH002.02.3.050 FR1.0 Z2 008 HA B	5170077	☉	2,00	4,00	50	2,3	8	1,00	2	HA
BCH002.02.3.050 FR1.0 Z2 010 HA B	5170078	☉	2,00	4,00	50	2,3	10	1,00	2	HA
BCH002.02.3.050 FR1.0 Z2 012 HA B	5170079	☉	2,00	4,00	50	2,3	12	1,00	2	HA
BCH002.02.3.050 FR1.0 Z2 015 HA B	5170080	☉	2,00	4,00	50	2,3	15	1,00	2	HA
BCH002.02.3.050 FR1.0 Z2 018 HA B	5170093	☉	2,00	4,00	50	2,3	18	1,00	2	HA
BCH002.02.3.050 FR1.0 Z2 020 HA B	5170094	☉	2,00	4,00	50	2,3	20	1,00	2	HA
BCH02.5.02.9.075 FR1.25 Z2 025 HA B	5170095	☉	2,50	6,00	75	2,9	25	1,25	2	HA
BCH003.03.5.060 FR1.5 Z2 010 HA B	5170096	☉	3,00	6,00	60	3,5	10	1,50	2	HA
BCH003.03.5.060 FR1.5 Z2 015 HA B	5170097	☉	3,00	6,00	60	3,5	15	1,50	2	HA
BCH003.03.5.060 FR1.5 Z2 020 HA B	5170098	☉	3,00	6,00	60	3,5	20	1,50	2	HA
BCH003.03.5.075 FR1.5 Z2 025 HA B	5170099	☉	3,00	6,00	75	3,5	25	1,50	2	HA
BCH004.04.6.060 FR2.0 Z2 010 HA B	5170100	☉	4,00	6,00	60	4,6	10	2,00	2	HA
BCH004.04.6.060 FR2.0 Z2 015 HA B	5170101	☉	4,00	6,00	60	4,6	15	2,00	2	HA
BCH004.04.6.060 FR2.0 Z2 020 HA B	5170102	☉	4,00	6,00	60	4,6	20	2,00	2	HA
BCH004.04.6.075 FR2.0 Z2 025 HA B	5170103	☉	4,00	6,00	75	4,6	25	2,00	2	HA
BCH004.04.6.075 FR2.0 Z2 030 HA B	5170104	☉	4,00	6,00	75	4,6	30	2,00	2	HA
BCH004.04.6.075 FR2.0 Z2 035 HA B	5170105	☉	4,00	6,00	75	4,6	35	2,00	2	HA
BCH005.05.8.060 FR2.5 Z2 015 HA B	5170106	☉	5,00	6,00	60	5,8	15	2,50	2	HA
BCH005.05.8.060 FR2.5 Z2 020 HA B	5170107	☉	5,00	6,00	60	5,8	20	2,50	2	HA
BCH006.06.9.060 FR3.0 Z2 015 HA B	5170108	☉	6,00	6,00	60	6,9	15	3,00	2	HA
BCH006.06.9.060 FR3.0 Z2 020 HA B	5170128	☉	6,00	6,00	60	6,9	20	3,00	2	HA
BCH006.06.9.060 FR3.0 Z2 025 HA B	5170129	☉	6,00	6,00	60	6,9	25	3,00	2	HA
BCH006.06.9.075 FR3.0 Z2 030 HA B	5170130	☉	6,00	6,00	75	6,9	30	3,00	2	HA
BCH006.06.9.075 FR3.0 Z2 035 HA B	5170131	☉	6,00	6,00	75	6,9	35	3,00	2	HA

Bestellbeispiel Order example: 1 Stück piece 5170051 oder or BCH001.01.2.050 FR0.5 Z2 003 HA B

Genauere Schnittwertempfehlung siehe Seite 276

Detailed cutting recommendations, see page 276

BALLtec SC Hardened

Kugelfräser „Form B“ Z4

Ballnose „Form B“ Z4

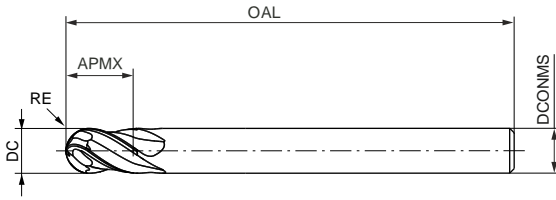

Hard Facts	
Fräserdurchmesser:	6,00 - 10,00 mm
Beschichtung:	TiSiN PVD
Schneidenzahl:	Z = 4
Drallwinkel:	35°
Radiusgenauigkeit:	R = ±0,005 wenn d1 ≤ 6 mm R = ±0,01 wenn d1 > 6 mm
Anwendung:	Geeignet zur Bearbeitung von Werkstoffen bis 66 HRC.
Diameter:	6.00 - 10.00 mm
Coating:	TiSiN PVD
Amount/Teeth:	Z = 4
Helix angle:	35°
Tolerance:	R = ±0.005 if d1 ≤ 6 mm R = ±0.01 if d1 > 6 mm
Application:	Machining of materials up to 66 HRC.

BALLtec SC Hardened		
ISO		
P	P.1	<input type="checkbox"/>
	P.2	<input type="checkbox"/>
	P.3	<input type="checkbox"/>
	P.4	<input type="checkbox"/>
	P.5	<input type="checkbox"/>
K	K.1	<input type="checkbox"/>
	K.2	<input type="checkbox"/>
	K.3	<input type="checkbox"/>
H	H.1	<input checked="" type="checkbox"/>
	H.2	<input checked="" type="checkbox"/>
	H.3	<input checked="" type="checkbox"/>
	H.4	<input checked="" type="checkbox"/>

Artikelbezeichnung Item Code	Bestell-Nr. Ordering No.	Verfügbarkeit Availability	Abmessungen [mm] Dimensions [mm]					ZEFF ⚙	Schaft Shank
			DC	DCONMS	OAL	APMX	RE		
BCH006.06.9.060 FR3.0 Z4 HA B	5169930	●	6,00	6,00	60	6,9	3	4	HA
BCH008.09.2.064 FR4.0 Z4 HA B	5169931	●	8,00	8,00	64	9,2	4	4	HA
BCH010.011.075 FR5.0 Z4 HA B	5169933	●	10,00	10,00	75	11,5	5	4	HA

Bestellbeispiel Order example: 1 Stück piece 5169930 oder or BCH006.06.9.060 FR3.0 Z4 HA B
 Genaue Schnittwertempfehlung siehe Seite 276
 Detailed cutting recommendations, see page 276

- Verfügbar ab Lager Available from stock
- Kurzfristig lieferbar Available at short notice
- Lieferzeit auf Anfrage Delivery time on request

BALLtec SC Hardened

Kugelfräser mit Hals „Form B“ Z4

Ballnose cutter neck „Form B“ Z4

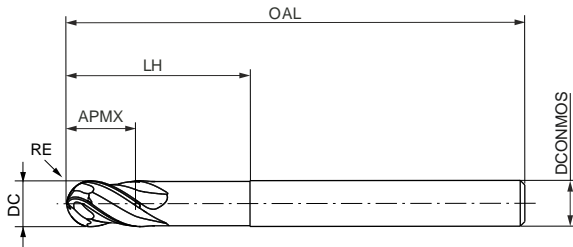

Hard Facts	
Fräserdurchmesser:	3,00 - 6,00 mm
Beschichtung:	TiSiN PVD
Schneidenzahl:	Z = 4
Drallwinkel:	35°
Radiusgenauigkeit:	R = ±0,005 wenn d1 ≤ 6 mm R = ±0,01 wenn d1 > 6 mm
Anwendung:	Geeignet zur Bearbeitung von Werkstoffen bis 66 HRC.
Diameter:	3.00 - 6.00 mm
Coating:	TiSiN PVD
Amount/Teeth:	Z = 4
Helix angle:	35°
Tolerance:	R = ±0.005 if d1 ≤ 6 mm R = ±0.01 if d1 > 6 mm
Application:	Machining of materials up to 66 HRC.

BALLtec SC Hardened		
ISO		
P	P.1	□
	P.2	□
	P.3	□
	P.4	□
	P.5	□
K	K.1	□
	K.2	□
	K.3	□
H	H.1	■
	H.2	■
	H.3	■
	H.4	■

Artikelbezeichnung Item Code	Bestell-Nr. Ordering No.	Verfügbarkeit Availability	Abmessungen [mm] Dimensions [mm]						ZEIFF	Schaft Shank
			DC	DCONMS	OAL	APMX	LH	RE		
BCH003.03.5.060 FR1.5 Z4 010 HA B	5169934	●	3,00	6,00	60	3,5	10	1,5	4	HA
BCH004.04.6.060 FR2.0 Z4 010 HA B	5169935	●	4,00	6,00	60	4,6	10	2	4	HA
BCH005.05.8.060 FR2.5 Z4 015 HA B	5169936	○	5,00	6,00	60	5,8	15	2,5	4	HA
BCH006.06.9.060 FR3.0 Z4 020 HA B	5169937	●	6,00	6,00	60	6,9	20	3	4	HA

Bestellbeispiel Order example: 1 Stück piece 5169934 oder or BCH003.03.5.060 FR1.5 Z4 010 HA B

Genauere Schnittwertempfehlung siehe Seite 276

Detailed cutting recommendations, see page 276

BALLtec SC N

Kugelfräser mit Hals „Form B“ Z2
Ballnose cutter neck „Form B“ Z2

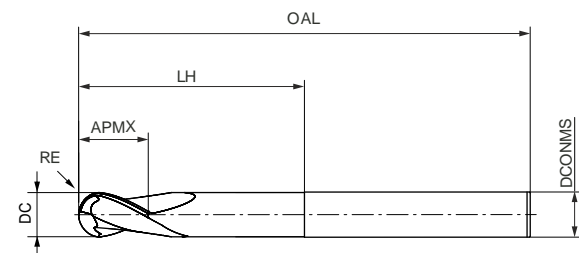

Hard Facts	
Fräserdurchmesser:	1,00 - 20,00 mm
Beschichtung:	TiBXZr PVD
Schneidenzahl:	Z = 2
Drallwinkel:	30°
Radiusgenauigkeit:	R = ± 0,005
Diameter:	1.00 - 20.00 mm
Coating:	TiBX2r PVD
Amount/Teeth:	Z = 2
Helix angle:	30°
Tolerance:	R = ± 0.005

BALLtec SC N		
ISO		
M	M.1	□
	M.2	□
N	N.1	■
	N.2	■
	N.3	□

Artikelbezeichnung Item Code	Bestell-Nr. Ordering No.	Verfügbarkeit Availability	Abmessungen [mm] Dimensions [mm]						ZEFF	Schaft Shank
			DC	DCONMS	OAL	APMX	LH	RE		
BCN001.01.5.075 FR0.5 Z2 020 HA B	5164140	●	1,00	4,00	75,00	1,50	20,00	0,50	2	HA
BCN01.5.02.5.075 FR0.8 Z2 020 HA B	5164143	●	1,50	4,00	75,00	2,50	20,00	0,75	2	HA
BCN002.003.075 FR1.0 Z2 020 HA B	5164145	●	2,00	4,00	75,00	3,00	20,00	1,00	2	HA
BCN003.04.5.057 FR1.5 Z2 020 HA B	5164146	●	3,00	6,00	57,00	4,50	20,00	1,50	2	HA
BCN004.006.057 FR2.0 Z2 020 HA B	5164148	●	4,00	6,00	57,00	6,00	20,00	2,00	2	HA
BCN006.009.057 FR3.0 Z2 020 HA B	5164149	●	6,00	6,00	57,00	9,00	20,00	3,00	2	HA
BCN008.012.090 FR4.0 Z2 035 HA B	5164150	●	8,00	8,00	90,00	12,00	35,00	4,00	2	HA
BCN010.015.100 FR5.0 Z2 050 HA B	5164337	⦿	10,00	10,00	100,00	15,00	50,00	5,00	2	HA
BCN012.018.110 FR6.0 Z2 050 HA B	5164339	⦿	12,00	12,00	110,00	18,00	50,00	6,00	2	HA
BCN016.024.150 FR8.0 Z2 100 HA B	5164341	⦿	16,00	16,00	150,00	24,00	100,00	8,00	2	HA
BCN020.030.150 FR10.0 Z2 100 HA B	5164345	⦿	20,00	20,00	150,00	30,00	100,00	10,00	2	HA

Bestellbeispiel Order example: 1 Stück piece 5164140 oder or BCN001.01.5.075 FR0.5 Z2 020 HA B
Genauere Schnittwertempfehlung siehe Seite 277
Detailed cutting recommendations, see page 277

- Verfügbar ab Lager Available from stock
- ⦿ Kurzfristig lieferbar Available at short notice
- Lieferzeit auf Anfrage Delivery time on request

BALLtec SC Graphite

Kugelfräser mit Hals „Form B“ Z2

Ballnose cutter neck „Form B“ Z2

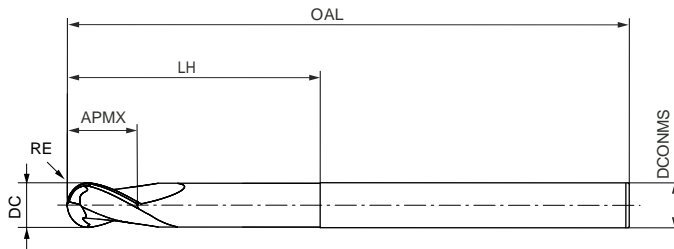

Hard Facts	
Fräserdurchmesser:	0,40 - 10,00 mm
Beschichtung:	Diamantbeschichtung
Schneidenzahl:	Z = 2
Drallwinkel:	35°
Radiusgenauigkeit:	R = ±0,005 wenn d1 ≤ 2 mm R = +0,01 / -0,015 wenn d1 > 2 mm
Anwendung:	Geeignet zur Bearbeitung von Graphitelektroden. Durch eingeeengte Radiustoleranz vorwiegend zum Schlichten und Vorschlichten eingesetzt.
Diameter:	0.40 - 10.00 mm
Coating:	Diamond coating
Amount/Teeth:	Z = 2
Helix angle:	35°
Tolerance:	R = ±0.005 if d1 ≤ 2 mm R = +0.01 / -0.015 if d1 > 2 mm
Application:	Suitable for machining graphite electrodes. Mainly used for finishing and pre-finishing due to narrowed radius tolerance.

BALLtec SC Graphite		
ISO		
N	N.4	■

Artikelbezeichnung Item Code	Bestell-Nr. Ordering No.	Verfügbarkeit Availability	Abmessungen [mm] Dimensions [mm]							Z ZEFF	Schaft Shank
			DC	DCONMS	OAL	APMX	LH	RE			
BCG00.4.00.6.050 FR0.2 Z2 01.2 HA B	5170143	☉	0,40	4,00	50	0,6	1,2	0,2	2	HA	
BCG00.4.00.6.050 FR0.2 Z2 02.5 HA B	5170144	☉	0,40	4,00	50	0,6	2,5	0,2	2	HA	
BCG00.4.00.6.050 FR0.2 Z2 005 HA B	5170145	☉	0,40	4,00	50	0,6	5	0,2	2	HA	
BCG00.5.00.8.050 FR0.25 Z2 01.5 HA B	5170146	☉	0,50	4,00	50	0,8	1,5	0,25	2	HA	
BCG00.5.00.8.050 FR0.25 Z2 03.5 HA B	5170147	☉	0,50	4,00	50	0,8	3,5	0,25	2	HA	
BCG00.5.00.8.050 FR0.25 Z2 005 HA B	5170148	☉	0,50	4,00	50	0,8	5	0,25	2	HA	
BCG00.5.00.8.050 FR0.25 Z2 007 HA B	5170149	☉	0,50	4,00	50	0,8	7	0,25	2	HA	
BCG00.5.00.8.050 FR0.25 Z2 010 HA B	5170150	☉	0,50	4,00	50	0,8	10	0,25	2	HA	
BCG00.6.00.9.050 FR0.3 Z2 01.2 HA B	5170151	☉	0,60	4,00	50	0,9	1,2	0,3	2	HA	
BCG00.6.00.9.050 FR0.3 Z2 03.5 HA B	5170152	☉	0,60	4,00	50	0,9	3,5	0,3	2	HA	
BCG00.6.00.9.050 FR0.3 Z2 005 HA B	5170153	☉	0,60	4,00	50	0,9	5	0,3	2	HA	
BCG00.6.00.9.050 FR0.3 Z2 007 HA B	5170154	☉	0,60	4,00	50	0,9	7	0,3	2	HA	
BCG00.6.00.9.050 FR0.3 Z2 010 HA B	5170155	☉	0,60	4,00	50	0,9	10	0,3	2	HA	
BCG00.6.00.9.050 FR0.3 Z2 012 HA B	5170156	☉	0,60	4,00	50	0,9	12	0,3	2	HA	

Bestellbeispiel Order example: 1 Stück piece 5170143 oder or BCG00.4.00.6.050 FR0.2 Z2 01.2 HA B

Genauere Schnittwertempfehlung siehe Seite 278

Detailed cutting recommendations, see page 278

BALLtec SC Graphite

Kugelfräser mit Hals „Form B“ Z2

Ballnose cutter neck „Form B“ Z2

Artikelbezeichnung Item Code	Bestell-Nr. Ordering No.	Verfügbarkeit Availability	Abmessungen [mm] Dimensions [mm]						NEFF	Schaft Shank
			DC	DCONMS	OAL	APMX	LH	RE		
BCG00.8.01.2.050 FR0.4 Z2 005 HA B	5170157	●	0,80	4,00	50	1,2	5	0,4	2	HA
BCG00.8.01.2.050 FR0.4 Z2 010 HA B	5170158	●	0,80	4,00	50	1,2	10	0,4	2	HA
BCG00.8.01.2.050 FR0.4 Z2 012 HA B	5170159	●	0,80	4,00	50	1,2	12	0,4	2	HA
BCG00.8.01.2.050 FR0.4 Z2 016 HA B	5170160	●	0,80	4,00	50	1,2	16	0,4	2	HA
BCG001.01.5.050 FR0.5 Z2 005 HA B	5170161	●	1,00	4,00	50	1,5	5	0,5	2	HA
BCG001.01.5.050 FR0.5 Z2 010 HA B	5170162	●	1,00	4,00	50	1,5	10	0,5	2	HA
BCG001.01.5.050 FR0.5 Z2 015 HA B	5170312	●	1,00	4,00	50	1,5	15	0,5	2	HA
BCG001.01.5.050 FR0.5 Z2 020 HA B	5170313	●	1,00	4,00	50	1,5	20	0,5	2	HA
BCG01.5.02.3.050 FR0.75 Z2 010 HA B	5170314	●	1,50	4,00	50	2,3	10	0,75	2	HA
BCG01.5.02.3.050 FR0.75 Z2 015 HA B	5170315	●	1,50	4,00	50	2,3	15	0,75	2	HA
BCG01.5.02.3.050 FR0.75 Z2 020 HA B	5170316	●	1,50	4,00	50	2,3	20	0,75	2	HA
BCG01.5.02.3.075 FR0.75 Z2 025 HA B	5170317	●	1,50	4,00	75	2,3	25	0,75	2	HA
BCG002.004.050 FR1.0 Z2 010 HA B	5170318	●	2,00	4,00	50	4	10	1	2	HA
BCG002.004.050 FR1.0 Z2 015 HA B	5170319	●	2,00	4,00	50	4	15	1	2	HA
BCG002.004.075 FR1.0 Z2 020 HA B	5170320	●	2,00	4,00	75	4	20	1	2	HA
BCG002.004.075 FR1.0 Z2 025 HA B	5170321	●	2,00	4,00	75	4	25	1	2	HA
BCG003.04.5.050 FR1.5 Z2 005 HA B	5170322	●	3,00	4,00	50	4,5	5	1,5	2	HA
BCG003.006.050 FR1.5 Z2 010 HA B	5170323	●	3,00	4,00	50	6	10	1,5	2	HA
BCG003.006.050 FR1.5 Z2 015 HA B	5170327	●	3,00	4,00	50	6	15	1,5	2	HA
BCG003.006.075 FR1.5 Z2 020 HA B	5170328	●	3,00	4,00	75	6	20	1,5	2	HA
BCG003.006.075 FR1.5 Z2 025 HA B	5170329	●	3,00	4,00	75	6	25	1,5	2	HA
BCG003.006.075 FR1.5 Z2 030 HA B	5170330	●	3,00	4,00	75	6	30	1,5	2	HA
BCG004.008.050 FR2.0 Z2 015 HA B	5170331	●	4,00	4,00	50	8	15	2	2	HA
BCG004.008.075 FR2.0 Z2 020 HA B	5170332	●	4,00	4,00	75	8	20	2	2	HA
BCG004.008.075 FR2.0 Z2 025 HA B	5170333	●	4,00	4,00	75	8	25	2	2	HA
BCG004.008.100 FR2.0 Z2 045 HA B	5170334	●	4,00	4,00	100	8	45	2	2	HA
BCG005.010.057 FR2.5 Z2 025 HA B	5170335	●	5,00	6,00	57	10	25	2,5	2	HA
BCG005.010.100 FR2.5 Z2 045 HA B	5170336	●	5,00	6,00	100	10	45	2,5	2	HA
BCG006.012.075 FR3.0 Z2 020 HA B	5170337	●	6,00	6,00	75	12	20	3	2	HA
BCG006.012.075 FR3.0 Z2 025 HA B	5170338	●	6,00	6,00	75	12	25	3	2	HA
BCG006.012.075 FR3.0 Z2 030 HA B	5170339	●	6,00	6,00	75	12	30	3	2	HA
BCG006.012.100 FR3.0 Z2 045 HA B	5170340	●	6,00	6,00	100	12	45	3	2	HA
BCG006.012.100 FR3.0 Z2 060 HA B	5170341	●	6,00	6,00	100	12	60	3	2	HA
BCG008.016.063 FR4.0 Z2 025 HA B	5170342	●	8,00	8,00	63	16	25	4	2	HA
BCG008.016.100 FR4.0 Z2 045 HA B	5170344	●	8,00	8,00	100	16	45	4	2	HA
BCG008.016.150 FR4.0 Z2 060 HA B	5170345	●	8,00	8,00	150	16	60	4	2	HA
BCG010.020.072 FR5.0 Z2 025 HA B	5170346	●	10,00	10,00	72	20	25	5	2	HA
BCG010.020.100 FR5.0 Z2 045 HA B	5170347	●	10,00	10,00	100	20	45	5	2	HA
BCG010.020.125 FR5.0 Z2 060 HA B	5170348	●	10,00	10,00	125	20	60	5	2	HA

Bestellbeispiel Order example: 1 Stück piece 5170157oder or BCG00.8.01.2.050 FR0.4 Z2 005 HA B

Genauere Schnittwertempfehlung siehe Seite 278

Detailed cutting recommendations, see page 278

● Verfügbar ab Lager Available from stock

○ Kurzfristig lieferbar Available at short notice

○ Lieferzeit auf Anfrage Delivery time on request

TORROtec SC Universal

Eckradiusfräser mit Hals „Form B“ Z2
Toric cutter neck „Form B“ Z2

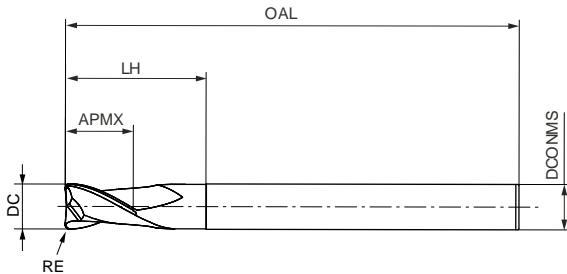

Hard Facts	
Fräserdurchmesser:	0,40 - 6,00 mm
Beschichtung:	AlTiN PVD
Schneidenzahl:	Z = 2
Drallwinkel:	30°
Radiusgenauigkeit:	R = ± 0,005 bis ø 6 mm R = ± 0,01 ab ø 8 mm
Anwendung:	Geeignet zur Bearbeitung von Werkstoffen bis 55 HRC.
Diameter:	0.40 - 6.00 mm
Coating:	AlTiN PVD
Amount/Teeth:	Z = 2
Helix angle:	30°
Tolerance:	R = ± 0.005 until ø 6 mm R = ± 0.01 from ø 8 mm
Application:	Machining of materials up to 55 HRC.

TORROtec SC Universal		
ISO		
P	P.1	■
	P.2	■
	P.3	■
	P.4	■
	P.5	■
M	M.1	□
	M.2	□
K	K.1	□
	K.2	□
	K.3	□
H	H.1	■
	H.2	□

Artikelbezeichnung Item Code	Bestell-Nr. Ordering No.	Verfügbarkeit Availability	Abmessungen [mm] Dimensions [mm]							Z	Schaft Shank
			DC	DCONMS	OAL	APMX	LH	RE			
TCU00.4.00.4.050 FR0.1 Z2 00.7 HA B	5164373	●	0,40	4,00	50,00	0,45	0,75	0,10	2	HA	
TCU00.4.00.4.050 FR0.1 Z2 001 HA B	5164374	●	0,40	4,00	50,00	0,45	1,00	0,10	2	HA	
TCU00.4.00.4.050 FR0.1 Z2 01.5 HA B	5164152	●	0,40	4,00	50,00	0,45	1,50	0,10	2	HA	
TCU00.4.00.4.050 FR0.1 Z2 002 HA B	5164376	●	0,40	4,00	50,00	0,45	2,00	0,10	2	HA	
TCU00.4.00.4.060 FR0.1 Z2 002 HA B	5164377	●	0,40	6,00	60,00	0,45	2,00	0,10	2	HA	
TCU00.4.00.4.060 FR0.1 Z2 003 HA B	5164378	●	0,40	6,00	60,00	0,45	3,00	0,10	2	HA	
TCU00.5.00.6.050 FR0.1 Z2 01.5 HA B	5164387	●	0,50	4,00	50,00	0,60	1,50	0,10	2	HA	
TCU00.5.00.6.050 FR0.1 Z2 002 HA B	5164388	●	0,50	4,00	50,00	0,60	2,00	0,10	2	HA	
TCU00.5.00.6.050 FR0.1 Z2 003 HA B	5164160	●	0,50	4,00	50,00	0,60	3,00	0,10	2	HA	
TCU00.5.00.6.050 FR0.1 Z2 004 HA B	5164389	●	0,50	4,00	50,00	0,60	4,00	0,10	2	HA	
TCU00.5.00.6.050 FR0.1 Z2 005 HA B	5164392	●	0,50	4,00	50,00	0,60	5,00	0,10	2	HA	
TCU00.5.00.6.050 FR0.1 Z2 006 HA B	5164393	●	0,50	4,00	50,00	0,60	6,00	0,10	2	HA	
TCU00.6.00.7.050 FR0.1 Z2 002 HA B	5164394	●	0,60	4,00	50,00	0,70	2,00	0,10	2	HA	
TCU00.6.00.7.050 FR0.1 Z2 003 HA B	5164161	●	0,60	4,00	50,00	0,70	3,00	0,10	2	HA	

Bestellbeispiel Order example: 1 Stück piece 5164373 oder or TCU00.4.00.4.050 FR0.1 Z2 001 HA B
Genauere Schnittwertempfehlung siehe Seite 279 und 280
Detailed cutting recommendations, see page 279 and 280

TORROtec SC Universal

Eckradiusfräser mit Hals „Form B“ Z2

Toric cutter neck „Form B“ Z2

Artikelbezeichnung Item Code	Bestell-Nr. Ordering No.	Verfügbarkeit Availability	Abmessungen [mm] Dimensions [mm]						ZIFF	Schaft Shank
			DC	DCONMS	OAL	APMX	LH	RE		
TCU00.6.00.7.050 FR0.1 Z2 004 HA B	5164395	●	0,60	4,00	50,00	0,70	4,00	0,10	2	HA
TCU00.6.00.7.050 FR0.1 Z2 005 HA B	5164397	●	0,60	4,00	50,00	0,70	5,00	0,10	2	HA
TCU00.6.00.7.050 FR0.1 Z2 006 HA B	5164398	●	0,60	4,00	50,00	0,70	6,00	0,10	2	HA
TCU00.8.00.9.050 FR0.1 Z2 003 HA B	5164163	●	0,80	4,00	50,00	0,90	3,00	0,10	2	HA
TCU00.8.00.9.050 FR0.1 Z2 004 HA B	5164400	●	0,80	4,00	50,00	0,90	4,00	0,10	2	HA
TCU00.8.00.9.050 FR0.1 Z2 006 HA B	5164401	●	0,80	4,00	50,00	0,90	6,00	0,10	2	HA
TCU00.8.00.9.050 FR0.1 Z2 008 HA B	5164402	●	0,80	4,00	50,00	0,90	8,00	0,10	2	HA
TCU001.01.1.050 FR0.2 Z2 003 HA B	5164165	●	1,00	4,00	50,00	1,10	3,00	0,20	2	HA
TCU001.01.1.050 FR0.2 Z2 004 HA B	5164404	●	1,00	4,00	50,00	1,10	4,00	0,20	2	HA
TCU001.01.1.050 FR0.2 Z2 005 HA B	5164166	●	1,00	4,00	50,00	1,10	5,00	0,20	2	HA
TCU001.01.1.050 FR0.2 Z2 006 HA B	5164412	●	1,00	4,00	50,00	1,10	6,00	0,20	2	HA
TCU001.01.1.050 FR0.2 Z2 008 HA B	5164413	●	1,00	4,00	50,00	1,10	8,00	0,20	2	HA
TCU001.01.1.050 FR0.2 Z2 010 HA B	5164415	●	1,00	4,00	50,00	1,10	10,00	0,20	2	HA
TCU01.5.01.7.050 FR0.2 Z2 005 HA B	5164416	●	1,50	4,00	50,00	1,70	5,00	0,20	2	HA
TCU01.5.01.7.050 FR0.2 Z2 006 HA B	5164417	●	1,50	4,00	50,00	1,70	6,00	0,20	2	HA
TCU01.5.01.7.050 FR0.2 Z2 008 HA B	5164418	●	1,50	4,00	50,00	1,70	8,00	0,20	2	HA
TCU01.5.01.7.050 FR0.2 Z2 010 HA B	5164419	●	1,50	4,00	50,00	1,70	10,00	0,20	2	HA
TCU01.5.01.7.050 FR0.2 Z2 012 HA B	5164420	●	1,50	4,00	50,00	1,70	12,00	0,20	2	HA
TCU01.5.01.7.050 FR0.2 Z2 015 HA B	5164421	●	1,50	4,00	50,00	1,70	15,00	0,20	2	HA
TCU002.02.2.050 FR0.2 Z2 006 HA B	5164167	●	2,00	4,00	50,00	2,20	6,00	0,20	2	HA
TCU002.02.2.050 FR0.2 Z2 008 HA B	5164423	●	2,00	4,00	50,00	2,20	8,00	0,20	2	HA
TCU002.02.2.050 FR0.2 Z2 010 HA B	5164424	●	2,00	4,00	50,00	2,20	10,00	0,20	2	HA
TCU002.02.2.050 FR0.2 Z2 012 HA B	5164426	●	2,00	4,00	50,00	2,20	12,00	0,20	2	HA
TCU002.02.2.050 FR0.2 Z2 015 HA B	5164427	●	2,00	4,00	50,00	2,20	15,00	0,20	2	HA
TCU002.02.2.050 FR0.2 Z2 018 HA B	5164430	●	2,00	4,00	50,00	2,20	18,00	0,20	2	HA
TCU002.02.2.050 FR0.2 Z2 020 HA B	5164431	●	2,00	4,00	50,00	2,20	20,00	0,20	2	HA
TCU002.02.2.050 FR0.5 Z2 006 HA B	5164170	●	2,00	4,00	50,00	2,20	6,00	0,50	2	HA
TCU002.02.2.050 FR0.5 Z2 008 HA B	5164443	●	2,00	4,00	50,00	2,20	8,00	0,50	2	HA
TCU002.02.2.050 FR0.5 Z2 010 HA B	5164445	●	2,00	4,00	50,00	2,20	10,00	0,50	2	HA
TCU002.02.2.050 FR0.5 Z2 012 HA B	5164448	●	2,00	4,00	50,00	2,20	12,00	0,50	2	HA
TCU002.02.2.050 FR0.5 Z2 015 HA B	5164449	●	2,00	4,00	50,00	2,20	15,00	0,50	2	HA
TCU002.02.2.050 FR0.5 Z2 018 HA B	5164450	●	2,00	4,00	50,00	2,20	18,00	0,50	2	HA
TCU002.02.2.050 FR0.5 Z2 020 HA B	5164452	●	2,00	4,00	50,00	2,20	20,00	0,50	2	HA
TCU003.03.3.060 FR0.2 Z2 010 HA B	5164171	●	3,00	6,00	60,00	3,30	10,00	0,20	2	HA
TCU003.03.3.060 FR0.2 Z2 015 HA B	5164453	●	3,00	6,00	60,00	3,30	15,00	0,20	2	HA
TCU003.03.3.060 FR0.2 Z2 020 HA B	5164454	●	3,00	6,00	60,00	3,30	20,00	0,20	2	HA
TCU003.03.3.075 FR0.2 Z2 025 HA B	5164455	●	3,00	6,00	75,00	3,30	25,00	0,20	2	HA
TCU003.03.3.060 FR0.5 Z2 010 HA B	5164175	●	3,00	6,00	60,00	3,30	10,00	0,50	2	HA
TCU003.03.3.060 FR0.5 Z2 015 HA B	5164457	●	3,00	6,00	60,00	3,30	15,00	0,50	2	HA
TCU003.03.3.060 FR0.5 Z2 020 HA B	5164458	●	3,00	6,00	60,00	3,30	20,00	0,50	2	HA
TCU003.03.3.075 FR0.5 Z2 025 HA B	5164459	●	3,00	6,00	75,00	3,30	25,00	0,50	2	HA
TCU004.04.4.060 FR0.2 Z2 010 HA B	5164460	●	4,00	6,00	60,00	4,40	10,00	0,20	2	HA
TCU004.04.4.060 FR0.2 Z2 015 HA B	5164177	●	4,00	6,00	60,00	4,40	15,00	0,20	2	HA
TCU004.04.4.060 FR0.2 Z2 020 HA B	5164462	●	4,00	6,00	60,00	4,40	20,00	0,20	2	HA
TCU004.04.4.075 FR0.2 Z2 025 HA B	5164463	●	4,00	6,00	75,00	4,40	25,00	0,20	2	HA
TCU004.04.4.075 FR0.2 Z2 030 HA B	5164464	●	4,00	6,00	75,00	4,40	30,00	0,20	2	HA
TCU004.04.4.075 FR0.2 Z2 035 HA B	5164465	●	4,00	6,00	75,00	4,40	35,00	0,20	2	HA
TCU004.04.4.060 FR0.5 Z2 010 HA B	5164466	●	4,00	6,00	60,00	4,40	10,00	0,50	2	HA
TCU004.04.4.060 FR0.5 Z2 015 HA B	5164183	●	4,00	6,00	60,00	4,40	15,00	0,50	2	HA
TCU004.04.4.060 FR0.5 Z2 020 HA B	5164468	●	4,00	6,00	60,00	4,40	20,00	0,50	2	HA
TCU004.04.4.075 FR0.5 Z2 025 HA B	5164469	●	4,00	6,00	75,00	4,40	25,00	0,50	2	HA
TCU004.04.4.075 FR0.5 Z2 030 HA B	5164470	●	4,00	6,00	75,00	4,40	30,00	0,50	2	HA
TCU004.04.4.075 FR0.5 Z2 035 HA B	5164471	●	4,00	6,00	75,00	4,40	35,00	0,50	2	HA

Bestellbeispiel Order example: 1 Stück piece 5164395 oder or TCU00.6.00.7.050 FR0.1 Z2 004 HA B

Genauere Schnittwertempfehlung siehe Seite 279 und 280

Detailed cutting recommendations, see page 279 and 280

- Verfügbar ab Lager Available from stock
- Kurzfristig lieferbar Available at short notice
- Lieferzeit auf Anfrage Delivery time on request

TORROtec SC Universal

Eckradiusfräser mit Hals „Form B“ Z2

Toric cutter neck „Form B“ Z2

Artikelbezeichnung Item Code	Bestell-Nr. Ordering No.	Verfügbarkeit Availability	Abmessungen [mm] Dimensions [mm]						NEFFO Z	Schaft Shank
			DC	DCONMS	OAL	APMX	LH	RE		
TCU006.007.060 FR0.2 Z2 015 HA B	5164187	●	6,00	6,00	60,00	7,00	15,00	0,20	2	HA
TCU006.007.060 FR0.2 Z2 020 HA B	5164472	①	6,00	6,00	60,00	7,00	20,00	0,20	2	HA
TCU006.007.060 FR0.2 Z2 025 HA B	5164474	①	6,00	6,00	60,00	7,00	25,00	0,20	2	HA
TCU006.007.075 FR0.2 Z2 030 HA B	5164475	①	6,00	6,00	75,00	7,00	30,00	0,20	2	HA
TCU006.007.075 FR0.2 Z2 035 HA B	5164476	①	6,00	6,00	75,00	7,00	35,00	0,20	2	HA
TCU006.007.060 FR0.3 Z2 015 HA B	5164477	①	6,00	6,00	60,00	7,00	15,00	0,30	2	HA
TCU006.007.060 FR0.3 Z2 020 HA B	5164478	①	6,00	6,00	60,00	7,00	20,00	0,30	2	HA
TCU006.007.060 FR0.3 Z2 025 HA B	5164479	①	6,00	6,00	60,00	7,00	25,00	0,30	2	HA
TCU006.007.075 FR0.3 Z2 030 HA B	5164480	①	6,00	6,00	75,00	7,00	30,00	0,30	2	HA
TCU006.007.075 FR0.3 Z2 035 HA B	5164481	①	6,00	6,00	75,00	7,00	35,00	0,30	2	HA
TCU006.007.060 FR0.5 Z2 015 HA B	5164188	●	6,00	6,00	60,00	7,00	15,00	0,50	2	HA
TCU006.007.060 FR0.5 Z2 020 HA B	5164482	①	6,00	6,00	60,00	7,00	20,00	0,50	2	HA
TCU006.007.060 FR0.5 Z2 025 HA B	5164485	①	6,00	6,00	60,00	7,00	25,00	0,50	2	HA
TCU006.007.075 FR0.5 Z2 030 HA B	5164486	①	6,00	6,00	75,00	7,00	30,00	0,50	2	HA
TCU006.007.075 FR0.5 Z2 035 HA B	5164488	①	6,00	6,00	75,00	7,00	35,00	0,50	2	HA
TCU006.007.060 FR1.0 Z2 015 HA B	5164190	●	6,00	6,00	60,00	7,00	15,00	1,00	2	HA
TCU006.007.060 FR1.0 Z2 020 HA B	5164491	①	6,00	6,00	60,00	7,00	20,00	1,00	2	HA
TCU006.007.060 FR1.0 Z2 025 HA B	5164495	①	6,00	6,00	60,00	7,00	25,00	1,00	2	HA
TCU006.007.075 FR1.0 Z2 030 HA B	5164496	①	6,00	6,00	75,00	7,00	30,00	1,00	2	HA
TCU006.007.075 FR1.0 Z2 035 HA B	5164497	①	6,00	6,00	75,00	7,00	35,00	1,00	2	HA

Bestellbeispiel Order example: 1 Stück piece 5164187 oder or TCU006.007.060 FR0.2 Z2 015 HA B

Genauere Schnittwertempfehlung siehe Seite 279 und 280

Detailed cutting recommendations, see page 279 and 280

TORROtec SC Hardened

Eckradiusfräser mit Hals „Form B“ Z2

Toric cutter neck „Form B“ Z2

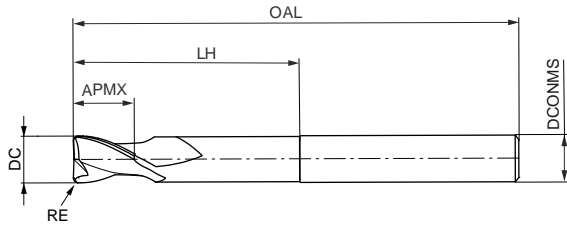

Hard Facts	
Fräserdurchmesser:	0,40 - 6,00 mm
Beschichtung:	TiSiN PVD
Schneidenzahl:	Z = 2
Drallwinkel:	28°
Radiusgenauigkeit:	R = ±0,005 wenn d1 ≤ 6 mm R = ±0,01 wenn d1 > 6 mm
Anwendung:	Geeignet zur Bearbeitung von Werkstoffen bis 66 HRC.
Diameter:	0.40 - 6.00 mm
Coating:	TiSiN PVD
Amount/Teeth:	Z = 2
Helix angle:	28°
Tolerance:	R = ±0.005 if d1 ≤ 6 mm R = ±0.01 if d1 > 6 mm
Application:	Machining of materials up to 66 HRC.

TORROtec SC Hardened		
ISO		
P	P.1	<input type="checkbox"/>
	P.2	<input type="checkbox"/>
	P.3	<input type="checkbox"/>
	P.4	<input type="checkbox"/>
	P.5	<input type="checkbox"/>
K	K.1	<input type="checkbox"/>
	K.2	<input type="checkbox"/>
	K.3	<input type="checkbox"/>
H	H.1	<input checked="" type="checkbox"/>
	H.2	<input checked="" type="checkbox"/>
	H.3	<input checked="" type="checkbox"/>
	H.4	<input checked="" type="checkbox"/>

Artikelbezeichnung Item Code	Bestell-Nr. Ordering No.	Verfügbarkeit Availability	Abmessungen [mm] Dimensions [mm]							ZEFF	Schaft Shank
			DC	DCONMS	OAL	APMX	LH	RE			
TCH00.4.00.5.050 FR0.1 Z2 00.7 HA B	5170374	●	0,40	4,00	50	0,5	0,75	0,1	2	HA	
TCH00.4.00.5.050 FR0.1 Z2 001 HA B	5170375	●	0,40	4,00	50	0,5	1	0,1	2	HA	
TCH00.4.00.5.050 FR0.1 Z2 01.5 HA B	5170376	●	0,40	4,00	50	0,5	1,5	0,1	2	HA	
TCH00.4.00.5.050 FR0.1 Z2 002 HA B	5170377	●	0,40	4,00	50	0,5	2	0,1	2	HA	
TCH00.4.00.5.060 FR0.1 Z2 002 HA B	5170378	●	0,40	6,00	60	0,5	2	0,1	2	HA	
TCH00.4.00.5.060 FR0.1 Z2 003 HA B	5170379	●	0,40	6,00	60	0,5	3	0,1	2	HA	
TCH00.5.00.6.050 FR0.1 Z2 01.5 HA B	5170380	●	0,50	4,00	50	0,6	1,5	0,1	2	HA	
TCH00.5.00.6.050 FR0.1 Z2 002 HA B	5170381	●	0,50	4,00	50	0,6	2	0,1	2	HA	
TCH00.5.00.6.050 FR0.1 Z2 003 HA B	5170382	●	0,50	4,00	50	0,6	3	0,1	2	HA	
TCH00.5.00.6.050 FR0.1 Z2 004 HA B	5170383	●	0,50	4,00	50	0,6	4	0,1	2	HA	
TCH00.5.00.6.050 FR0.1 Z2 005 HA B	5170384	●	0,50	4,00	50	0,6	5	0,1	2	HA	
TCH00.5.00.6.050 FR0.1 Z2 006 HA B	5170385	●	0,50	4,00	50	0,6	6	0,1	2	HA	

Bestellbeispiel Order example: 1 Stück piece 5170374 oder or TCH00.4.00.5.050 FR0.1 Z2 00.7 HA B
 Genaue Schnittwertempfehlung siehe Seite 280 und 281
 Detailed cutting recommendations, see page 280 and 281

- Verfügbar ab Lager Available from stock
- Kurzfristig lieferbar Available at short notice
- Lieferzeit auf Anfrage Delivery time on request

TORROtec SC Hardened

Eckradiusfräser mit Hals „Form B“ Z2

Toric cutter neck „Form B“ Z2

Artikelbezeichnung Item Code	Bestell-Nr. Ordering No.	Verfügbarkeit Availability	Abmessungen [mm] Dimensions [mm]						NEFF	Schaft Shank
			DC	DCONMS	OAL	APMX	LH	RE		
TCH00.6.00.7.050 FR0.1 Z2 002 HA B	5170393	○	0,60	4,00	50	0,7	2	0,1	2	HA
TCH00.6.00.7.050 FR0.1 Z2 003 HA B	5170394	○	0,60	4,00	50	0,7	3	0,1	2	HA
TCH00.6.00.7.050 FR0.1 Z2 004 HA B	5170395	○	0,60	4,00	50	0,7	4	0,1	2	HA
TCH00.6.00.7.050 FR0.1 Z2 005 HA B	5170396	○	0,60	4,00	50	0,7	5	0,1	2	HA
TCH00.6.00.7.050 FR0.1 Z2 006 HA B	5170397	○	0,60	4,00	50	0,7	6	0,1	2	HA
TCH00.8.00.9.050 FR0.1 Z2 003 HA B	5170398	○	0,80	4,00	50	0,9	3	0,1	2	HA
TCH00.8.00.9.050 FR0.1 Z2 004 HA B	5170399	○	0,80	4,00	50	0,9	4	0,1	2	HA
TCH00.8.00.9.050 FR0.1 Z2 006 HA B	5170400	○	0,80	4,00	50	0,9	6	0,1	2	HA
TCH00.8.00.9.050 FR0.1 Z2 008 HA B	5170401	○	0,80	4,00	50	0,9	8	0,1	2	HA
TCH001.01.2.050 FR0.2 Z2 003 HA B	5170402	○	1,00	4,00	50	1,2	3	0,2	2	HA
TCH001.01.2.050 FR0.2 Z2 004 HA B	5170403	○	1,00	4,00	50	1,2	4	0,2	2	HA
TCH001.01.2.050 FR0.2 Z2 005 HA B	5170404	○	1,00	4,00	50	1,2	5	0,2	2	HA
TCH001.01.2.050 FR0.2 Z2 006 HA B	5170411	○	1,00	4,00	50	1,2	6	0,2	2	HA
TCH001.01.2.050 FR0.2 Z2 008 HA B	5170412	○	1,00	4,00	50	1,2	8	0,2	2	HA
TCH001.01.2.050 FR0.2 Z2 010 HA B	5170413	○	1,00	4,00	50	1,2	10	0,2	2	HA
TCH01.5.01.7.050 FR0.2 Z2 005 HA B	5170414	○	1,50	4,00	50	1,7	5	0,2	2	HA
TCH01.5.01.7.050 FR0.2 Z2 006 HA B	5170415	○	1,50	4,00	50	1,7	6	0,2	2	HA
TCH01.5.01.7.050 FR0.2 Z2 008 HA B	5170416	○	1,50	4,00	50	1,7	8	0,2	2	HA
TCH01.5.01.7.050 FR0.2 Z2 010 HA B	5170417	○	1,50	4,00	50	1,7	10	0,2	2	HA
TCH01.5.01.7.050 FR0.2 Z2 012 HA B	5170418	○	1,50	4,00	50	1,7	12	0,2	2	HA
TCH01.5.01.7.050 FR0.2 Z2 015 HA B	5170431	○	1,50	4,00	50	1,7	15	0,2	2	HA
TCH002.02.3.050 FR0.2 Z2 006 HA B	5170432	○	2,00	4,00	50	2,3	6	0,2	2	HA
TCH002.02.3.050 FR0.2 Z2 008 HA B	5170433	○	2,00	4,00	50	2,3	8	0,2	2	HA
TCH002.02.3.050 FR0.2 Z2 010 HA B	5170434	○	2,00	4,00	50	2,3	10	0,2	2	HA
TCH002.02.3.050 FR0.2 Z2 012 HA B	5170435	○	2,00	4,00	50	2,3	12	0,2	2	HA
TCH002.02.3.050 FR0.2 Z2 015 HA B	5170436	○	2,00	4,00	50	2,3	15	0,2	2	HA
TCH002.02.3.050 FR0.2 Z2 018 HA B	5170437	○	2,00	4,00	50	2,3	18	0,2	2	HA
TCH002.02.3.050 FR0.2 Z2 020 HA B	5170438	○	2,00	4,00	50	2,3	20	0,2	2	HA
TCH002.02.3.050 FR0.5 Z2 006 HA B	5170446	○	2,00	4,00	50	2,3	6	0,5	2	HA
TCH002.02.3.050 FR0.5 Z2 008 HA B	5170447	○	2,00	4,00	50	2,3	8	0,5	2	HA
TCH002.02.3.050 FR0.5 Z2 010 HA B	5170448	○	2,00	4,00	50	2,3	10	0,5	2	HA
TCH002.02.3.050 FR0.5 Z2 012 HA B	5170449	○	2,00	4,00	50	2,3	12	0,5	2	HA
TCH002.02.3.050 FR0.5 Z2 015 HA B	5170450	○	2,00	4,00	50	2,3	15	0,5	2	HA
TCH002.02.3.050 FR0.5 Z2 018 HA B	5170451	○	2,00	4,00	50	2,3	18	0,5	2	HA
TCH002.02.3.050 FR0.5 Z2 020 HA B	5170452	○	2,00	4,00	50	2,3	20	0,5	2	HA
TCH003.03.5.060 FR0.2 Z2 010 HA B	5170453	○	3,00	6,00	60	3,5	10	0,2	2	HA
TCH003.03.5.060 FR0.2 Z2 015 HA B	5170454	○	3,00	6,00	60	3,5	15	0,2	2	HA
TCH003.03.5.060 FR0.2 Z2 020 HA B	5170455	○	3,00	6,00	60	3,5	20	0,2	2	HA
TCH003.03.5.075 FR0.2 Z2 025 HA B	5170456	○	3,00	6,00	75	3,5	25	0,2	2	HA
TCH003.03.5.060 FR0.5 Z2 010 HA B	5170457	○	3,00	6,00	60	3,5	10	0,5	2	HA
TCH003.03.5.060 FR0.5 Z2 015 HA B	5170470	○	3,00	6,00	60	3,5	15	0,5	2	HA
TCH003.03.5.060 FR0.5 Z2 020 HA B	5170471	○	3,00	6,00	60	3,5	20	0,5	2	HA
TCH003.03.5.075 FR0.5 Z2 025 HA B	5170472	○	3,00	6,00	75	3,5	25	0,5	2	HA
TCH004.04.6.060 FR0.2 Z2 010 HA B	5170473	○	4,00	6,00	60	4,6	10	0,2	2	HA
TCH004.04.6.060 FR0.2 Z2 015 HA B	5170474	○	4,00	6,00	60	4,6	15	0,2	2	HA
TCH004.04.6.060 FR0.2 Z2 020 HA B	5170475	○	4,00	6,00	60	4,6	20	0,2	2	HA
TCH004.04.6.075 FR0.2 Z2 025 HA B	5170476	○	4,00	6,00	75	4,6	25	0,2	2	HA
TCH004.04.6.075 FR0.2 Z2 030 HA B	5170477	○	4,00	6,00	75	4,6	30	0,2	2	HA
TCH004.04.6.075 FR0.2 Z2 035 HA B	5170479	○	4,00	6,00	75	4,6	35	0,2	2	HA
TCH004.04.6.060 FR0.5 Z2 010 HA B	5170483	○	4,00	6,00	60	4,6	10	0,5	2	HA
TCH004.04.6.060 FR0.5 Z2 015 HA B	5170485	○	4,00	6,00	60	4,6	15	0,5	2	HA

Bestellbeispiel Order example: 1 Stück piece 5170393 oder or TCH00.6.00.7.050 FR0.1 Z2 002 HA B

Genauere Schnittwertempfehlung siehe Seite 280 und 281

Detailed cutting recommendations, see page 280 and 281

TORROtec SC Hardened

Eckradiusfräser mit Hals „Form B“ Z2

Toric cutter neck „Form B“ Z2

Artikelbezeichnung Item Code	Bestell-Nr. Ordering No.	Verfügbarkeit Availability	Abmessungen [mm] Dimensions [mm]						ZIFF	Schaft Shank
			DC	DCONMS	OAL	APMX	LH	RE		
TCH004.04.6.060 FR0.5 Z2 020 HA B	5170486	●	4,00	6,00	60	4,6	20	0,5	2	HA
TCH004.04.6.075 FR0.5 Z2 025 HA B	5170487	●	4,00	6,00	75	4,6	25	0,5	2	HA
TCH004.04.6.075 FR0.5 Z2 030 HA B	5170488	●	4,00	6,00	75	4,6	30	0,5	2	HA
TCH004.04.6.075 FR0.5 Z2 035 HA B	5170489	●	4,00	6,00	75	4,6	35	0,5	2	HA
TCH006.06.9.060 FR0.2 Z2 015 HA B	5170490	●	6,00	6,00	60	6,9	15	0,2	2	HA
TCH006.06.9.060 FR0.2 Z2 020 HA B	5170501	●	6,00	6,00	60	6,9	20	0,2	2	HA
TCH006.06.9.060 FR0.2 Z2 025 HA B	5170502	●	6,00	6,00	60	6,9	25	0,2	2	HA
TCH006.06.9.075 FR0.2 Z2 030 HA B	5170503	●	6,00	6,00	75	6,9	30	0,2	2	HA
TCH006.06.9.075 FR0.2 Z2 035 HA B	5170504	●	6,00	6,00	75	6,9	35	0,2	2	HA
TCH006.06.9.060 FR0.3 Z2 015 HA B	5170505	●	6,00	6,00	60	6,9	15	0,3	2	HA
TCH006.06.9.060 FR0.3 Z2 020 HA B	5170506	●	6,00	6,00	60	6,9	20	0,3	2	HA
TCH006.06.9.060 FR0.3 Z2 025 HA B	5170507	●	6,00	6,00	60	6,9	25	0,3	2	HA
TCH006.06.9.075 FR0.3 Z2 030 HA B	5170508	●	6,00	6,00	75	6,9	30	0,3	2	HA
TCH006.06.9.075 FR0.3 Z2 035 HA B	5170511	●	6,00	6,00	75	6,9	35	0,3	2	HA
TCH006.06.9.060 FR0.5 Z2 015 HA B	5170512	●	6,00	6,00	60	6,9	15	0,5	2	HA
TCH006.06.9.060 FR0.5 Z2 020 HA B	5170513	●	6,00	6,00	60	6,9	20	0,5	2	HA
TCH006.06.9.060 FR0.5 Z2 025 HA B	5170514	●	6,00	6,00	60	6,9	25	0,5	2	HA
TCH006.06.9.075 FR0.5 Z2 030 HA B	5170515	●	6,00	6,00	75	6,9	30	0,5	2	HA
TCH006.06.9.075 FR0.5 Z2 035 HA B	5170516	●	6,00	6,00	75	6,9	35	0,5	2	HA
TCH006.06.9.060 FR1.0 Z2 015 HA B	5170517	●	6,00	6,00	60	6,9	15	1,0	2	HA
TCH006.06.9.060 FR1.0 Z2 020 HA B	5170518	●	6,00	6,00	60	6,9	20	1,0	2	HA
TCH006.06.9.060 FR1.0 Z2 025 HA B	5170519	●	6,00	6,00	60	6,9	25	1,0	2	HA
TCH006.06.9.075 FR1.0 Z2 030 HA B	5170520	●	6,00	6,00	75	6,9	30	1,0	2	HA
TCH006.06.9.075 FR1.0 Z2 035 HA B	5170521	●	6,00	6,00	75	6,9	35	1,0	2	HA

Bestellbeispiel Order example: 1 Stück piece 5170486 oder or TCH004.04.6.060 FR0.5 Z2 020 HA B
 Genaue Schnittwertempfehlung siehe Seite 280 und 281
 Detailed cutting recommendations, see page 280 and 281

- Verfügbar ab Lager Available from stock
- Kurzfristig lieferbar Available at short notice
- Lieferzeit auf Anfrage Delivery time on request

TORROtec SC N

Eckradiusfräser mit Hals „Form B“ Z2

Toric cutter neck „Form B“ Z2

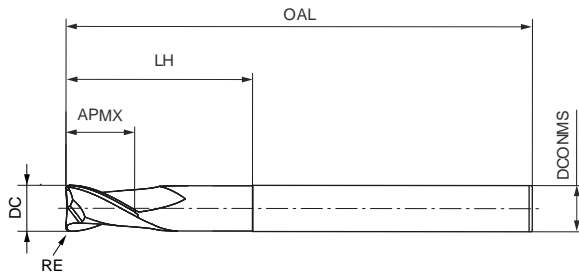

Hard Facts	
Fräserdurchmesser:	2,00 - 20,00 mm
Beschichtung:	TiBX2r PVD
Schneidenzahl:	Z = 2
Drallwinkel:	30°
Radiusgenauigkeit:	R = ± 0,005 bis ø 6 mm R = ± 0,01 ab ø 8 mm
Diameter:	2.00 - 20.00 mm
Coating:	TiBX2r PVD
Amount/Teeth:	Z = 2
Helix angle:	30°
Tolerance:	R = ± 0.005 until ø 6 mm R = ± 0.01 from ø 8 mm

TORROtec SC		
ISO		
M	M.1	□
	M.2	□
N	N.1	■
	N.2	■
	N.3	□

Artikelbezeichnung Item Code	Bestell-Nr. Ordering No.	Verfügbarkeit Availability	Abmessungen [mm] Dimensions [mm]						NEFF	Schaft Shank
			DC	DCONMS	OAL	APMX	LH	RE		
TCN002.002.050 FR0.2 Z2 010 HA B	5164499	○	2,00	4,00	50,00	2,00	10,00	0,20	2	HA
TCN002.002.050 FR0.5 Z2 010 HA B	5164194	●	2,00	4,00	50,00	2,00	10,00	0,50	2	HA
TCN003.003.050 FR0.2 Z2 012 HA B	5164405	○	3,00	4,00	50,00	3,00	12,00	0,20	2	HA
TCN003.003.050 FR0.5 Z2 012 HA B	5164195	●	3,00	4,00	50,00	3,00	12,00	0,50	2	HA
TCN004.004.050 FR0.2 Z2 015 HA B	5164406	○	4,00	4,00	50,00	4,00	15,00	0,20	2	HA
TCN004.004.050 FR0.5 Z2 015 HA B	5164196	●	4,00	4,00	50,00	4,00	15,00	0,50	2	HA
TCN006.006.057 FR0.2 Z2 021 HA B	5164407	○	6,00	6,00	57,00	6,00	21,00	0,20	2	HA
TCN006.006.057 FR0.5 Z2 021 HA B	5164198	●	6,00	6,00	57,00	6,00	21,00	0,50	2	HA
TCN006.006.057 FR1.0 Z2 021 HA B	5164409	○	6,00	6,00	57,00	6,00	21,00	1,00	2	HA
TCN006.006.075 FR1.0 Z2 030 HA B	5164201	●	6,00	6,00	75,00	6,00	30,00	1,00	2	HA
TCN008.008.063 FR0.5 Z2 027 HA B	5164202	●	8,00	8,00	63,00	8,00	27,00	0,50	2	HA
TCN008.008.063 FR1.0 Z2 030 HA B	5164204	●	8,00	8,00	63,00	8,00	30,00	1,00	2	HA
TCN010.010.072 FR0.5 Z2 032 HA B	5164501	○	10,00	10,00	72,00	10,00	32,00	0,50	2	HA
TCN010.010.100 FR1.0 Z2 044 HA B	5164503	○	10,00	10,00	100,00	10,00	40,00	1,00	2	HA
TCN012.012.110 FR1.5 Z2 060 HA B	5164505	○	12,00	12,00	110,00	12,00	60,00	1,50	2	HA
TCN016.016.092 FR2.0 Z2 044 HA B	5164507	○	16,00	16,00	92,00	16,00	44,00	2,00	2	HA
TCN020.020.104 FR2.0 Z2 054 HA B	5164509	○	20,00	20,00	104,00	20,00	54,00	2,00	2	HA

Bestellbeispiel Order example: 1 Stück piece 5164499 oder or TCN002.002.050 FR0.2 Z2 010 HA B

Genauere Schnittwertempfehlung siehe Seite 282

Detailed cutting recommendations, see page 282

FEEDtec SC Universal

Hochvorschubfräser mit Hals Z4
Highfeed cutter neck Z4

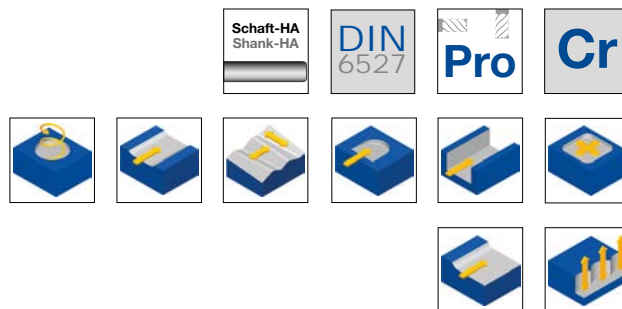
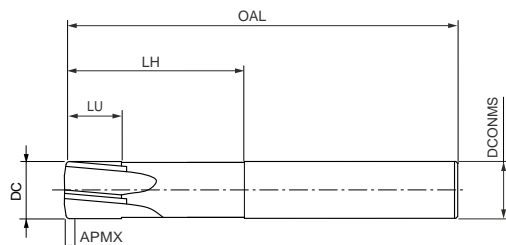

Hard Facts	
Fräserdurchmesser:	3,00 - 12,00 mm
Beschichtung:	AlTiN PVD
Schneidenzahl:	Z = 4
Drallwinkel:	5°
Anwendung:	Speziell zum Schruppen von Bauteilen mit einer Härte bis 55HRC. Sehr gute Laufruhe auch bei großen Tiefe.
Diameter:	3.00 - 12.00 mm
Coating:	AlTiN PVD
Amount/Teeth:	Z = 4
Helix angle:	5°
Application:	For roughing application in materials up to 55 HRC. Excellent running behaviour also at high projection length.

FEEDtec SC		
ISO		
P	P.1	■
	P.2	■
	P.3	■
	P.4	■
	P.5	■
K	K.1	■
	K.2	■
	K.3	■
H	H.1	■
	H.2	□

Artikelbezeichnung Item Code	Bestell-Nr. Ordering No.	Verfügbarkeit Availability	Abmessungen [mm] Dimensions [mm]						ZEFF ^o	Schaft Shank
			DC	DCONMS	OAL	LU	LH	APMX		
FCU003.003.060 Cr Z4 015 HA	5164205	●	3,00	6,00	60	3,00	15,00	0,13	4	HA
FCU004.004.060 Cr Z4 020 HA	5164207	●	4,00	6,00	60	4,00	20,00	0,17	4	HA
FCU005.005.060 Cr Z4 020 HA	5164209	●	5,00	6,00	60	5,00	20,00	0,20	4	HA
FCU006.006.060 Cr Z4 024 HA	5164210	●	6,00	6,00	60	6,00	24,00	0,24	4	HA
FCU008.008.064 Cr Z4 032 HA	5164212	●	8,00	8,00	64	8,00	32,00	0,31	4	HA
FCU010.010.100 Cr Z4 050 HA	5164213	●	10,00	10,00	100	10,00	50,00	0,39	4	HA
FCU012.012.100 Cr Z4 060 HA	5164351	⦿	12,00	12,00	100	12,00	60,00	0,46	4	HA

Bestellbeispiel Order example: 1 Stück piece 5164205 oder or FCU003.003.060 Cr Z4 015 HA
Genauere Schnittwertempfehlung siehe Seite 283
Detailed cutting recommendations, see page 283

- Verfügbar ab Lager Available from stock
- ⦿ Kurzfristig lieferbar Available at short notice
- Lieferzeit auf Anfrage Delivery time on request

FEEDtec SC Hardened

Hochvorschubfräser mit Hals Z4/Z6
High feed cutter neck Z4/Z6

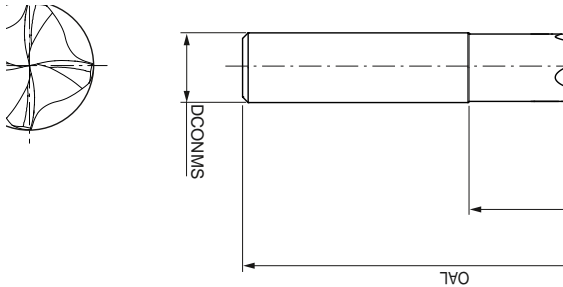

Hard Facts	
Fräserdurchmesser:	2,00 - 12,00 mm
Beschichtung:	TiSiN PVD
Schneidenzahl:	Z = 4/6 Z4 ≤ 6 mm, Z6 ≥ 6 mm
Drallwinkel:	12°
Anwendung:	Speziell zum Schruppen und Schlichten gehärteter Bauteile mit einer Härte ab 45 HRC, auch im unterbrochenen Schnitt, bis max.. 66 HRC. Durch die innovative Stirngeometrie sind beim Schlichten sehr hohe Oberflächengüten realisierbar.
Diameter:	2.00 - 12.00 mm
Coating:	TiSiN PVD
Amount/Teeth:	Z = 4/6 Z4 ≤ 6 mm, Z6 ≥ 6 mm
Helix angle:	12°
Application:	Designed for roughing and semifinishing application on hardened materials shorting from 45 HRC. High performance also in interrupted cuts, due to special geometry.

FEEDtec SC		
ISO		
P	P.1	<input type="checkbox"/>
	P.2	<input type="checkbox"/>
	P.3	<input type="checkbox"/>
	P.4	<input type="checkbox"/>
	P.5	<input type="checkbox"/>
K	K.1	<input type="checkbox"/>
	K.2	<input type="checkbox"/>
	K.3	<input type="checkbox"/>
H	H.1	<input checked="" type="checkbox"/>
	H.2	<input checked="" type="checkbox"/>
	H.3	<input checked="" type="checkbox"/>
	H.4	<input type="checkbox"/>

Artikelbezeichnung Item Code	Bestell-Nr. Ordering No.	Verfügbarkeit Availability	Abmessungen [mm]			Dimensions [mm]			ZEFF [®]	Schaft Shank
			DC	DCONMS	OAL	LU	LH	APMX		
FCH002.002.060 Cr Z4 006 HA	5164215	●	2,00	6,00	60,00	2,00	6,00	0,09	4	HA
FCH002.002.060 Cr Z4 010 HA	5164355	●	2,00	6,00	60,00	2,00	10,00	0,09	4	HA
FCH003.003.060 Cr Z4 009 HA	5164216	●	3,00	6,00	60,00	3,00	9,00	0,13	4	HA
FCH003.003.060 Cr Z4 015 HA	5164357	●	3,00	6,00	60,00	3,00	15,00	0,13	4	HA
FCH004.004.060 Cr Z4 012 HA	5164219	●	4,00	6,00	60,00	4,00	12,00	0,17	4	HA
FCH004.004.060 Cr Z4 020 HA	5164361	●	4,00	6,00	60,00	4,00	20,00	0,17	4	HA
FCH005.005.060 Cr Z4 015 HA	5164222	●	5,00	6,00	60,00	5,00	15,00	0,22	4	HA
FCH005.005.060 Cr Z4 020 HA	5164363	●	5,00	6,00	60,00	5,00	20,00	0,22	4	HA
FCH006.006.060 Cr Z4 018 HA	5164225	●	6,00	6,00	60,00	6,00	18,00	0,26	4	HA
FCH006.006.060 Cr Z4 024 HA	5164364	●	6,00	6,00	60,00	6,00	24,00	0,26	4	HA
FCH006.006.060 Cr Z6 018 HA	5164226	●	6,00	6,00	60,00	6,00	18,00	0,26	6	HA
FCH006.006.060 Cr Z6 024 HA	5164365	●	6,00	6,00	60,00	6,00	24,00	0,26	6	HA
FCH008.008.064 Cr Z6 024 HA	5164229	●	8,00	8,00	64,00	8,00	24,00	0,35	6	HA
FCH008.008.064 Cr Z6 032 HA	5164366	●	8,00	8,00	64,00	8,00	32,00	0,35	6	HA
FCH008.008.075 Cr Z6 040 HA	5164368	●	8,00	8,00	75,00	8,00	40,00	0,35	6	HA
FCH010.010.075 Cr Z6 030 HA	5164230	●	10,00	10,00	75,00	10,00	30,00	0,44	6	HA
FCH010.010.075 Cr Z6 040 HA	5164369	●	10,00	10,00	75,00	10,00	40,00	0,44	6	HA
FCH010.010.100 Cr Z6 050 HA	5164370	●	10,00	10,00	100,00	10,00	50,00	0,44	6	HA
FCH012.012.075 Cr Z6 036 HA	5164231	●	12,00	12,00	75,00	12,00	36,00	0,52	6	HA
FCH012.012.100 Cr Z6 048 HA	5164371	●	12,00	12,00	100,00	12,00	48,00	0,52	6	HA
FCH012.012.100 Cr Z6 060 HA	5164372	●	12,00	12,00	100,00	12,00	60,00	0,52	6	HA

Bestellbeispiel Order example: 1 Stück piece 5164215 oder or FCH002.002.060 Cr Z4 006 HA
Genauere Schnittwertempfehlung siehe Seite 284
Detailed cutting recommendations, see page 284

UNItec Pro H long neck FR

Lange Ausführung mit Hals und Eckenradius Z4

Execution long neck with full radius Z4

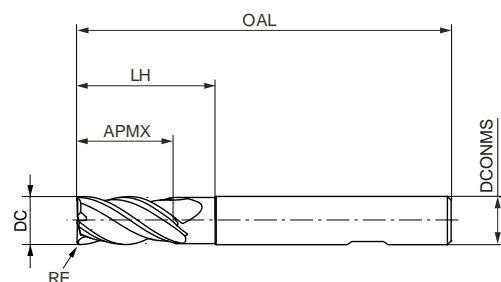

Hard Facts	
Fräserdurchmesser:	4,00 - 20,00 mm
Beschichtung:	TiSiN PVD
Schneidenzahl:	Z = 4
Drallwinkel:	42°
Besonderheiten:	Ungleichteilung
Diameter:	4.00 - 20.00 mm
Coating:	TiSiN PVD
Amount/Teeth:	Z = 4
Helix angle:	42°
Special feature:	Unequal division

UNITEC Pro H long neck FR		
ISO		
P	P.1	<input type="checkbox"/>
	P.2	<input type="checkbox"/>
	P.3	<input type="checkbox"/>
	P.4	<input type="checkbox"/>
	P.5	<input type="checkbox"/>
H	H.1	<input checked="" type="checkbox"/>
	H.2	<input checked="" type="checkbox"/>

Artikelbezeichnung Item Code	Bestell-Nr. Ordering No.	Verfügbarkeit Availability	Abmessungen [mm] Dimensions [mm]						ZEFF	Schaft Shank
			DC	DCONMS	OAL	LU	LH	RE		
UPH04.011.057 FR0.5 Z4 HB	5163463	●	*4,00	6,00	57,00	11,00	-	0,50	4	HB
UPH04.011.057 FR1.0 Z4 HB	5163465	●	*4,00	6,00	57,00	11,00	-	1,00	4	HB
UPH05.013.057 FR0.5 Z4 HB	5163467	○	*5,00	6,00	57,00	13,00	-	0,50	4	HB
UPH05.013.057 FR1.0 Z4 HB	5163468	○	*5,00	6,00	57,00	13,00	-	1,00	4	HB
UPH06.013.057 FR0.5 Z4 HB	5163469	●	6,00	6,00	57,00	13,00	20,00	0,50	4	HB
UPH06.013.057 FR1.0 Z4 HB	5163470	●	6,00	6,00	57,00	13,00	20,00	1,00	4	HB
UPH06.013.057 FR1.5 Z4 HB	5163471	○	6,00	6,00	57,00	13,00	20,00	1,50	4	HB
UPH06.013.057 FR2.0 Z4 HB	5163472	●	6,00	6,00	57,00	13,00	20,00	2,00	4	HB
UPH08.021.063 FR0.5 Z4 HB	5163473	●	8,00	8,00	63,00	21,00	25,00	0,50	4	HB
UPH08.021.063 FR1.0 Z4 HB	5163474	●	8,00	8,00	63,00	21,00	25,00	1,00	4	HB
UPH08.021.063 FR1.5 Z4 HB	5163475	○	8,00	8,00	63,00	21,00	25,00	1,50	4	HB
UPH08.021.063 FR2.0 Z4 HB	5163476	●	8,00	8,00	63,00	21,00	25,00	2,00	4	HB
UPH08.021.063 FR2.5 Z4 HB	5163477	○	8,00	8,00	63,00	21,00	25,00	2,50	4	HB
UPH08.021.063 FR3.0 Z4 HB	5163479	○	8,00	8,00	63,00	21,00	25,00	3,00	4	HB

Bestellbeispiel Order example: 1 Stück piece 5163463 oder or UPH04.011.057 FR0.5 Z4 HB

Genauere Schnittwertempfehlung siehe Seite 285

Detailed cutting recommendations, see page 285

* Ausführung ohne Hals

* Version without neck

● Verfügbar ab Lager Available from stock

● Kurzfristig lieferbar Available at short notice

○ Lieferzeit auf Anfrage Delivery time on request

UNitec Pro H long neck FR

Lange Ausführung mit Hals und Eckenradius Z4

Execution long neck with full radius Z4

Artikelbezeichnung Item Code	Bestell-Nr. Ordering No.	Verfügbarkeit Availability	Abmessungen [mm] Dimensions [mm]						NEFF	Schaft Shank
			DC	DCONMS	OAL	LU	LH	RE		
UPH10.022.072 FR0.5 Z4 HB	5163480	●	10,00	10,00	72,00	22,00	30,00	0,50	4	HB
UPH10.022.072 FR1.0 Z4 HB	5163481	●	10,00	10,00	72,00	22,00	30,00	1,00	4	HB
UPH10.022.072 FR1.5 Z4 HB	5163483	○	10,00	10,00	72,00	22,00	30,00	1,50	4	HB
UPH10.022.072 FR2.0 Z4 HB	5163484	●	10,00	10,00	72,00	22,00	30,00	2,00	4	HB
UPH10.022.072 FR2.5 Z4 HB	5163489	○	10,00	10,00	72,00	22,00	30,00	2,50	4	HB
UPH10.022.072 FR3.0 Z4 HB	5163490	○	10,00	10,00	72,00	22,00	30,00	3,00	4	HB
UPH12.026.083 FR0.5 Z4 HB	5163491	●	12,00	12,00	83,00	26,00	36,00	0,50	4	HB
UPH12.026.083 FR1.0 Z4 HB	5163492	●	12,00	12,00	83,00	26,00	36,00	1,00	4	HB
UPH12.026.083 FR1.5 Z4 HB	5163493	○	12,00	12,00	83,00	26,00	36,00	1,50	4	HB
UPH12.026.083 FR2.0 Z4 HB	5163494	●	12,00	12,00	83,00	26,00	36,00	2,00	4	HB
UPH12.026.083 FR2.5 Z4 HB	5163498	○	12,00	12,00	83,00	26,00	36,00	2,50	4	HB
UPH12.026.083 FR3.0 Z4 HB	5163499	○	12,00	12,00	83,00	26,00	36,00	3,00	4	HB
UPH12.026.083 FR4.0 Z4 HB	5163500	○	12,00	12,00	83,00	26,00	36,00	4,00	4	HB
UPH16.036.092 FR0.5 Z4 HB	5163501	●	16,00	16,00	92,00	36,00	42,00	0,50	4	HB
UPH16.036.092 FR1.0 Z4 HB	5163502	●	16,00	16,00	92,00	36,00	42,00	1,00	4	HB
UPH16.036.092 FR2.0 Z4 HB	5163503	●	16,00	16,00	92,00	36,00	42,00	2,00	4	HB
UPH16.036.092 FR2.5 Z4 HB	5163504	○	16,00	16,00	92,00	36,00	42,00	2,50	4	HB
UPH16.036.092 FR3.0 Z4 HB	5163506	○	16,00	16,00	92,00	36,00	42,00	3,00	4	HB
UPH16.036.092 FR4.0 Z4 HB	5163507	○	16,00	16,00	92,00	36,00	42,00	4,00	4	HB
UPH20.041.104 FR1.0 Z4 HB	5163508	○	20,00	20,00	104,00	41,00	55,00	1,00	4	HB
UPH20.041.104 FR2.0 Z4 HB	5163509	○	20,00	20,00	104,00	41,00	55,00	2,00	4	HB
UPH20.041.104 FR3.0 Z4 HB	5163511	○	20,00	20,00	104,00	41,00	55,00	3,00	4	HB
UPH20.041.104 FR4.0 Z4 HB	5163514	○	20,00	20,00	104,00	41,00	55,00	4,00	4	HB

Bestellbeispiel Order example: 1 Stück piece 5163480 oder or UPH10.022.072 FR0.5 Z4 HB

Genauere Schnittwertempfehlung siehe Seite 285

Detailed cutting recommendations, see page 285

UNItec Pro H overlength neck FR

Überlange Ausführung mit Hals und Eckenradius Z4

Execution overlength neck with full radius Z4

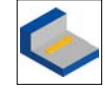
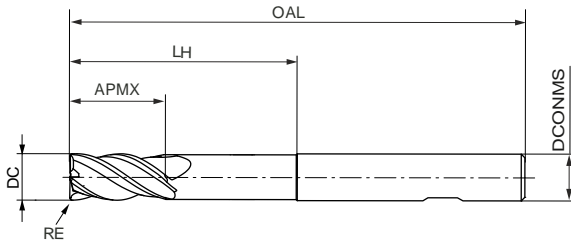

Hard Facts	
Fräserdurchmesser:	4,00 - 20,00 mm
Beschichtung:	TiSiN PVD
Schneidenzahl:	Z = 4
Drallwinkel:	42°
Besonderheiten:	Ungleichteilung
Diameter:	4.00 - 20.00 mm
Coating:	TiSiN PVD
Amount/Teeth:	Z = 4
Helix angle:	42°
Special feature:	Unequal division

UNItec Pro H overlength neck FR		
ISO		
P	P.1	<input type="checkbox"/>
	P.2	<input type="checkbox"/>
	P.3	<input type="checkbox"/>
	P.4	<input type="checkbox"/>
	P.5	<input type="checkbox"/>
H	H.1	<input checked="" type="checkbox"/>
	H.2	<input checked="" type="checkbox"/>

Artikelbezeichnung Item Code	Bestell-Nr. Ordering No.	Verfügbarkeit Availability	Abmessungen [mm] Dimensions [mm]						ZEFF	Schaft Shank
			DC	DCONMS	OAL	APMX	LH	RE		
UPH04.011.062 FR0.5 Z4 HB	5163515	●	4,00	6,00	62,00	11,00	22,00	0,50	4	HB
UPH04.011.062 FR1.0 Z4 HB	5163518	●	4,00	6,00	62,00	11,00	22,00	1,00	4	HB
UPH05.013.062 FR0.5 Z4 HB	5163519	○	5,00	6,00	62,00	13,00	24,00	0,50	4	HB
UPH05.013.062 FR1.0 Z4 HB	5163520	○	5,00	6,00	62,00	13,00	24,00	1,00	4	HB
UPH06.013.062 FR0.5 Z4 HB	5163522	●	6,00	6,00	62,00	13,00	25,00	0,50	4	HB
UPH06.013.062 FR1.0 Z4 HB	5163524	●	6,00	6,00	62,00	13,00	25,00	1,00	4	HB
UPH06.013.062 FR2.0 Z4 HB	5163525	●	6,00	6,00	62,00	13,00	25,00	2,00	4	HB
UPH08.021.068 FR1.0 Z4 HB	5163526	●	8,00	8,00	68,00	21,00	30,00	1,00	4	HB
UPH08.021.068 FR2.0 Z4 HB	5163528	●	8,00	8,00	68,00	21,00	30,00	2,00	4	HB
UPH10.022.080 FR0.5 Z4 HB	5163529	●	10,00	10,00	80,00	22,00	38,00	0,50	4	HB
UPH10.022.080 FR1.0 Z4 HB	5163530	●	10,00	10,00	80,00	22,00	38,00	1,00	4	HB
UPH10.022.080 FR1.5 Z4 HB	5163531	○	10,00	10,00	80,00	22,00	38,00	1,50	4	HB
UPH10.022.080 FR2.0 Z4 HB	5163532	●	10,00	10,00	80,00	22,00	38,00	2,00	4	HB
UPH10.022.080 FR3.0 Z4 HB	5163533	○	10,00	10,00	80,00	22,00	38,00	3,00	4	HB
UPH12.026.093 FR0.5 Z4 HB	5163534	●	12,00	12,00	93,00	26,00	46,00	0,50	4	HB
UPH12.026.093 FR1.0 Z4 HB	5163535	●	12,00	12,00	93,00	26,00	46,00	1,00	4	HB
UPH12.026.093 FR1.5 Z4 HB	5163536	○	12,00	12,00	93,00	26,00	46,00	1,50	4	HB
UPH12.026.093 FR2.0 Z4 HB	5163537	●	12,00	12,00	93,00	26,00	46,00	2,00	4	HB
UPH12.026.093 FR3.0 Z4 HB	5163538	○	12,00	12,00	93,00	26,00	46,00	3,00	4	HB
UPH16.036.108 FR0.5 Z4 HB	5163539	●	16,00	16,00	108,00	36,00	58,00	0,50	4	HB
UPH16.036.108 FR1.0 Z4 HB	5163540	●	16,00	16,00	108,00	36,00	58,00	1,00	4	HB
UPH16.036.108 FR2.0 Z4 HB	5163541	●	16,00	16,00	108,00	36,00	58,00	2,00	4	HB
UPH16.036.108 FR4.0 Z4 HB	5163542	○	16,00	16,00	108,00	36,00	58,00	4,00	4	HB
UPH20.041.126 FR1.0 Z4 HB	5163543	○	20,00	20,00	126,00	41,00	74,00	1,00	4	HB
UPH20.041.126 FR2.0 Z4 HB	5163550	○	20,00	20,00	126,00	41,00	74,00	2,00	4	HB
UPH20.041.126 FR4.0 Z4 HB	5163549	○	20,00	20,00	126,00	41,00	74,00	4,00	4	HB

Bestellbeispiel Order example: 1 Stück piece 5163515 oder or UPH04.011.062 FR0.5 Z4 HB

Genauere Schnittwertempfehlung siehe Seite 285

Detailed cutting recommendations, see page 285

● Verfügbar ab Lager Available from stock

● Kurzfristig lieferbar Available at short notice

○ Lieferzeit auf Anfrage Delivery time on request

UNItec Pro Hardened Superfinish FR

Restmaterialfräser Eckenradius und Hals Z5
Restmaterial cutter neck with full radius Z5

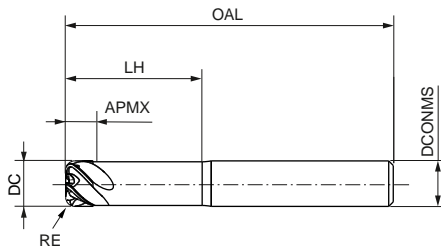

Hard Facts	
Fräserdurchmesser:	4,00 - 12,00 mm
Beschichtung:	AlTiSiN PVD
Schneidenzahl:	Z = 5
Drallwinkel:	~ 47°
Diameter:	4.00 - 12.00 mm
Coating:	AlTiSiN PVD
Amount/Teeth:	Z = 5
Helix angle:	~ 47°

UNItec Pro H		
ISO		
P	P.1	■
	P.2	■
	P.3	■
	P.4	■
	P.5	■
K	K.1	■
	K.2	■
	K.3	■
H	H.1	■
	H.2	■
	H.3	■
	H.4	■

Artikelbezeichnung Item Code	Bestell-Nr. Ordering No.	Verfügbarkeit Availability	Abmessungen [mm] Dimensions [mm]						ZEFF	Schaft Shank
			DC	DCONMS	OAL	APMX	LH	RE		
UPH004.04.2.060 FR0.5 Z5 012 HA SF	5164514	●	4,00	6,00	60,00	4,20	12,00	0,50	5	HA
UPH004.04.2.060 FR0.5 Z5 020 HA SF	5164516	●	4,00	6,00	60,00	4,20	20,00	0,50	5	HA
UPH004.04.2.060 FR1.0 Z5 012 HA SF	5164518	●	4,00	6,00	60,00	4,20	12,00	1,00	5	HA
UPH004.04.2.060 FR1.0 Z5 020 HA SF	5164519	●	4,00	6,00	60,00	4,20	20,00	1,00	5	HA
UPH005.05.2.060 FR0.5 Z5 015 HA SF	5164520	●	5,00	6,00	60,00	5,20	15,00	0,50	5	HA
UPH005.05.2.060 FR0.5 Z5 025 HA SF	5164521	●	5,00	6,00	60,00	5,20	25,00	0,50	5	HA
UPH005.05.2.060 FR1.0 Z5 015 HA SF	5164522	●	5,00	6,00	60,00	5,20	15,00	1,00	5	HA
UPH005.05.2.060 FR1.0 Z5 025 HA SF	5164533	●	5,00	6,00	60,00	5,20	25,00	1,00	5	HA
UPH006.06.3.060 FR0.5 Z5 018 HA SF	5164534	●	6,00	6,00	60,00	6,30	18,00	0,50	5	HA
UPH006.06.3.075 FR0.5 Z5 030 HA SF	5164536	●	6,00	6,00	75,00	6,30	30,00	0,50	5	HA
UPH006.06.3.060 FR1.0 Z5 018 HA SF	5164540	●	6,00	6,00	60,00	6,30	18,00	1,00	5	HA
UPH006.06.3.075 FR1.0 Z5 030 HA SF	5164542	●	6,00	6,00	75,00	6,30	30,00	1,00	5	HA
UPH008.08.4.064 FR0.5 Z5 024 HA SF	5164544	●	8,00	8,00	64,00	8,40	24,00	0,50	5	HA
UPH008.08.4.075 FR0.5 Z5 040 HA SF	5164545	●	8,00	8,00	75,00	8,40	40,00	0,50	5	HA
UPH008.08.4.064 FR1.0 Z5 024 HA SF	5164546	●	8,00	8,00	64,00	8,40	24,00	1,00	5	HA
UPH008.08.4.075 FR1.0 Z5 040 HA SF	5164547	●	8,00	8,00	75,00	8,40	40,00	1,00	5	HA
UPH010.10.5.075 FR1.0 Z5 030 HA SF	5164548	●	10,00	10,00	75,00	10,50	30,00	1,00	5	HA
UPH010.10.5.100 FR1.0 Z5 050 HA SF	5164550	●	10,00	10,00	100,00	10,50	50,00	1,00	5	HA
UPH010.10.5.075 FR2.0 Z5 030 HA SF	5164552	●	10,00	10,00	75,00	10,50	30,00	2,00	5	HA
UPH010.10.5.100 FR2.0 Z5 050 HA SF	5164554	●	10,00	10,00	100,00	10,50	50,00	2,00	5	HA
UPH012.12.5.100 FR1.0 Z5 036 HA SF	5164556	●	12,00	12,00	100,00	12,50	36,00	1,00	5	HA
UPH012.12.5.100 FR1.0 Z5 060 HA SF	5164558	●	12,00	12,00	100,00	12,50	60,00	1,00	5	HA
UPH012.12.5.100 FR2.0 Z5 036 HA SF	5164559	●	12,00	12,00	100,00	12,50	36,00	2,00	5	HA
UPH012.12.5.100 FR2.0 Z5 060 HA SF	5164560	●	12,00	12,00	100,00	12,50	60,00	2,00	5	HA

Bestellbeispiel Order example: 1 Stück piece 5164514 oder or UPH004.04.2.060 FR0.5 Z5 012 HA SF
Genauere Schnittwertempfehlung siehe Seite 286
Detailed cutting recommendations, see page 286

- Verfügbar ab Lager Available from stock
- Kurzfristig lieferbar Available at short notice
- Lieferzeit auf Anfrage Delivery time on request

Schnittwertempfehlung für Eckfräser, Vorschub und Schnittgeschwindigkeit
Recommended cutting values for corner milling cutters, feed and cutting speed

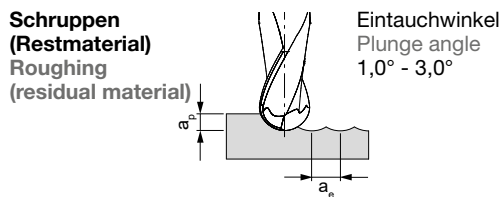

BALLtec SC Universal Z2/Z4

BZG	Kühlung Cooling			APMX [mm]	a _e [mm]	v _c [m/min]	f _z [mm/Zahn] f _z [mm/tooth]														
	Trocken Dry	Luft/MMS Air/MMS	Nass Wet				Fräserdurchmesser [mm] Cutter diameter [mm]														
							0,40	0,50	0,60	0,80	1,00	1,50	1,80	2,00	2,50	3,00	4,00	5,00	6,00	8,00	10,00
P	P1	●	●	●	0,05xD < 0,25xD	240 - 300	0,008	0,010	0,012	0,016	0,020	0,028	0,035	0,040	0,050	0,061	0,084	0,107	0,125	0,165	0,200
	P2	●	●	●	0,05xD < 0,25xD	240 - 300	0,008	0,010	0,012	0,016	0,020	0,028	0,035	0,040	0,050	0,061	0,084	0,107	0,125	0,165	0,200
	P3	●	●	●	0,05xD < 0,25xD	220 - 300	0,008	0,010	0,011	0,015	0,019	0,027	0,033	0,038	0,048	0,058	0,080	0,102	0,119	0,157	0,190
	P4		●	●	0,05xD < 0,25xD	240 - 280	0,008	0,010	0,012	0,016	0,020	0,028	0,035	0,040	0,050	0,061	0,084	0,107	0,125	0,165	0,200
	P5		●	●	0,05xD < 0,25xD	200 - 280	0,007	0,009	0,011	0,014	0,018	0,025	0,031	0,035	0,044	0,054	0,074	0,094	0,110	0,145	0,176
M	M1			●	0,05xD < 0,25xD	85 - 110	0,007	0,009	0,011	0,014	0,018	0,025	0,031	0,035	0,044	0,054	0,074	0,094	0,110	0,145	0,176
	M2			●	0,05xD < 0,25xD	60 - 85	0,006	0,007	0,009	0,012	0,015	0,020	0,026	0,029	0,037	0,045	0,061	0,078	0,091	0,120	0,146
K	K1	●	●	●	0,06xD < 0,3xD	250 - 300	0,010	0,012	0,014	0,019	0,024	0,034	0,042	0,048	0,060	0,073	0,101	0,128	0,150	0,198	0,240
	K2	●	●	●	0,06xD < 0,3xD	240 - 300	0,008	0,010	0,012	0,016	0,020	0,028	0,035	0,040	0,050	0,061	0,084	0,107	0,125	0,165	0,200
	K3	●	●	●	0,06xD < 0,3xD	240 - 300	0,006	0,007	0,009	0,012	0,015	0,020	0,026	0,029	0,037	0,045	0,061	0,078	0,091	0,120	0,146
H	H1	●	●		0,04xD < 0,18xD	160 - 280	0,006	0,007	0,009	0,012	0,015	0,020	0,026	0,029	0,037	0,045	0,061	0,078	0,091	0,120	0,146
	H2		●		0,015xD < 0,03xD	100 - 160	0,003	0,004	0,005	0,006	0,008	0,011	0,014	0,016	0,020	0,024	0,034	0,043	0,050	0,066	0,080

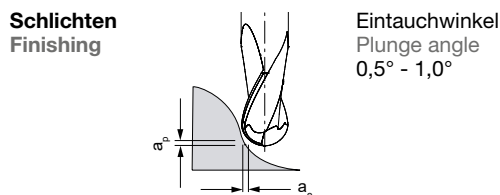

BALLtec SC Universal Z2/Z4

BZG	Kühlung Cooling			APMX [mm]	a _e [mm]	v _c [m/min]	f _z [mm/Zahn] f _z [mm/tooth]														
	Trocken Dry	Luft/MMS Air/MMS	Nass Wet				Fräserdurchmesser [mm] Cutter diameter [mm]														
							0,40	0,50	0,60	0,80	1,00	1,50	1,80	2,00	2,50	3,00	4,00	5,00	6,00	8,00	10,00
P	P1	●	●	●	0,015xD 0,025xD	280 - 340	0,008	0,010	0,011	0,015	0,019	0,027	0,033	0,038	0,048	0,058	0,080	0,102	0,119	0,157	0,190
	P2	●	●	●	0,014xD 0,024xD	260 - 320	0,008	0,010	0,011	0,015	0,019	0,027	0,033	0,038	0,048	0,058	0,080	0,102	0,119	0,157	0,190
	P3	●	●	●	0,013xD 0,023xD	240 - 320	0,007	0,009	0,011	0,014	0,018	0,025	0,032	0,036	0,045	0,055	0,076	0,097	0,113	0,149	0,181
	P4		●	●	0,013xD 0,023xD	260 - 300	0,008	0,010	0,011	0,015	0,019	0,027	0,033	0,038	0,048	0,058	0,080	0,102	0,119	0,157	0,190
	P5		●	●	0,013xD 0,023xD	220 - 300	0,007	0,008	0,010	0,013	0,017	0,023	0,029	0,033	0,042	0,051	0,070	0,089	0,105	0,138	0,167
M	M1			●	0,013xD 0,023xD	90 - 120	0,007	0,008	0,010	0,013	0,017	0,023	0,029	0,033	0,042	0,051	0,070	0,089	0,105	0,138	0,167
		●	●	●	0,012xD 0,022xD	70 - 90	0,006	0,007	0,008	0,011	0,014	0,019	0,024	0,028	0,035	0,042	0,058	0,074	0,087	0,114	0,139
K	K1	●	●	●	0,015xD 0,025xD	280 - 340	0,008	0,010	0,011	0,015	0,019	0,027	0,033	0,038	0,048	0,058	0,080	0,102	0,119	0,157	0,190
	K2	●	●	●	0,014xD 0,024xD	260 - 320	0,007	0,008	0,010	0,013	0,017	0,023	0,029	0,033	0,042	0,051	0,070	0,089	0,105	0,138	0,167
	K3	●	●	●	0,014xD 0,024xD	260 - 320	0,006	0,007	0,008	0,011	0,014	0,019	0,024	0,028	0,035	0,042	0,058	0,074	0,087	0,114	0,139
H	H1	●	●		0,012xD 0,022xD	160 - 280	0,006	0,007	0,009	0,012	0,014	0,020	0,025	0,029	0,036	0,044	0,061	0,077	0,090	0,119	0,144
	H2		●		0,008xD 0,018xD	120 - 160	0,004	0,005	0,006	0,008	0,010	0,013	0,017	0,019	0,024	0,029	0,040	0,051	0,060	0,079	0,096

* Angegebene Schnittdaten sind als Richtwert zu sehen, welche durch Versuche für jeden Anwendungsfall separat optimiert werden können.
* Recommended cutting data has to be seen as a reference which can be optimised for each application through trials separately.

Schnittwertempfehlung für Eckfräser, Vorschub und Schnittgeschwindigkeit
Recommended cutting values for corner milling cutters, feed and cutting speed

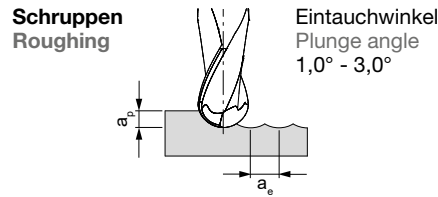

BALLtec SC Hardened Z2/Z4

BZG	Kühlung Cooling			APMX [mm]	a _e [mm]	v _c [m/min]	f _z [mm/Zahn] f _z [mm/tooth]													
	Trocken Dry	Luft/MMS Air/MMS	Nass Wet				Fräserdurchmesser [mm] Cutter diameter [mm]													
							0,40	0,50	0,60	0,80	1,00	1,50	1,80	2,00	2,50	3,00	4,00	5,00	6,00	
P	P1	●	●	●	0,05xD	< 0,25xD	250 - 300	0,008	0,010	0,012	0,016	0,020	0,028	0,035	0,040	0,050	0,061	0,084	0,107	0,125
		●	●	●	0,045xD	< 0,25xD	240 - 280	0,007	0,009	0,011	0,014	0,018	0,025	0,031	0,035	0,044	0,054	0,074	0,094	0,110
	P2	●	●	●	0,05xD	< 0,25xD	250 - 300	0,008	0,010	0,012	0,016	0,020	0,028	0,035	0,040	0,050	0,061	0,084	0,107	0,125
		●	●	●	0,045xD	< 0,25xD	240 - 280	0,007	0,009	0,011	0,014	0,018	0,025	0,031	0,035	0,044	0,054	0,074	0,094	0,110
	P3	●	●	●	0,05xD	< 0,25xD	250 - 300	0,008	0,010	0,011	0,015	0,019	0,027	0,033	0,038	0,048	0,058	0,080	0,102	0,119
		●	●	●	0,045xD	< 0,2xD	240 - 280	0,007	0,009	0,011	0,014	0,018	0,025	0,031	0,035	0,044	0,054	0,074	0,094	0,110
P4		●	●	0,04xD	< 0,2xD	220 - 260	0,006	0,007	0,009	0,012	0,015	0,020	0,026	0,029	0,037	0,045	0,061	0,078	0,091	
P5		●	●	0,05xD	< 0,25xD	240 - 280	0,008	0,010	0,012	0,016	0,020	0,028	0,035	0,040	0,050	0,061	0,084	0,107	0,125	
P6		●	●	0,05xD	< 0,25xD	240 - 280	0,007	0,009	0,011	0,014	0,018	0,025	0,031	0,035	0,044	0,054	0,074	0,094	0,110	
K	K1	●	●	●	0,06xD	< 0,3xD	250 - 300	0,010	0,012	0,014	0,019	0,024	0,034	0,042	0,048	0,060	0,073	0,101	0,128	0,150
		●	●	●	0,06xD	< 0,3xD	250 - 300	0,008	0,010	0,012	0,016	0,020	0,028	0,035	0,040	0,050	0,061	0,084	0,107	0,125
	K2	●	●	●	0,06xD	< 0,3xD	240 - 280	0,008	0,010	0,012	0,016	0,020	0,028	0,035	0,040	0,050	0,061	0,084	0,107	0,125
		●	●	●	0,06xD	< 0,3xD	240 - 280	0,007	0,009	0,011	0,014	0,018	0,025	0,031	0,035	0,044	0,054	0,074	0,094	0,110
	K3	●	●	●	0,06xD	< 0,3xD	250 - 300	0,006	0,007	0,009	0,012	0,015	0,020	0,026	0,029	0,037	0,045	0,061	0,078	0,091
		●	●	●	0,06xD	< 0,3xD	240 - 280	0,005	0,006	0,007	0,010	0,012	0,017	0,022	0,025	0,031	0,038	0,052	0,066	0,078
H	H1	●	●		0,04xD	< 0,18xD	220 - 280	0,006	0,007	0,009	0,012	0,015	0,020	0,026	0,029	0,037	0,045	0,061	0,078	0,091
		●	●		0,03xD	< 0,12xD	160 - 220	0,005	0,006	0,007	0,010	0,012	0,017	0,021	0,024	0,030	0,037	0,050	0,064	0,075
	H2		●		0,015xD	< 0,03xD	100 - 160	0,003	0,004	0,005	0,006	0,008	0,011	0,014	0,016	0,020	0,024	0,034	0,043	0,050
			●		0,008xD	< 0,018xD	60 - 100	0,002	0,003	0,004	0,005	0,006	0,008	0,011	0,012	0,015	0,018	0,025	0,032	0,038
	H3		●		0,005xD	< 0,015xD	40 - 80	0,002	0,002	0,003	0,004	0,004	0,006	0,008	0,009	0,011	0,013	0,019	0,024	0,028
		●	●		0,015xD	< 0,03xD	100 - 160	0,003	0,004	0,005	0,006	0,008	0,011	0,014	0,016	0,020	0,024	0,034	0,043	0,050

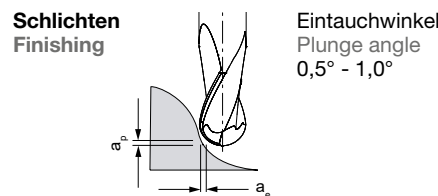

BALLtec SC Hardened Z2/Z4

BZG	Kühlung Cooling			APMX [mm]	a _e [mm]	v _c [m/min]	f _z [mm/Zahn] f _z [mm/tooth]															
	Trocken Dry	Luft/MMS Air/MMS	Nass Wet				Fräserdurchmesser [mm] Cutter diameter [mm]															
							0,40	0,50	0,60	0,80	1,00	1,50	1,80	2,00	2,50	3,00	4,00	5,00	6,00	8,00	10,00	
P	P1	●	●	●	0,015xD	0,025xD	280 - 340	0,008	0,010	0,011	0,015	0,019	0,027	0,033	0,038	0,048	0,058	0,080	0,102	0,119	0,157	0,190
	P2	●	●	●	0,014xD	0,024xD	260 - 320	0,008	0,010	0,011	0,015	0,019	0,027	0,033	0,038	0,048	0,058	0,080	0,102	0,119	0,157	0,190
	P3	●	●	●	0,013xD	0,023xD	240 - 320	0,007	0,009	0,011	0,014	0,018	0,025	0,032	0,036	0,045	0,055	0,076	0,097	0,113	0,149	0,181
	P4		●	●	0,013xD	0,023xD	260 - 300	0,008	0,010	0,011	0,015	0,019	0,027	0,033	0,038	0,048	0,058	0,080	0,102	0,119	0,157	0,190
	P5		●	●	0,013xD	0,023xD	220 - 300	0,007	0,008	0,010	0,013	0,017	0,023	0,029	0,033	0,042	0,051	0,070	0,089	0,105	0,138	0,167
K	K1	●	●	●	0,015xD	0,025xD	280 - 340	0,008	0,010	0,011	0,015	0,019	0,027	0,033	0,038	0,048	0,058	0,080	0,102	0,119	0,157	0,190
	K2	●	●	●	0,014xD	0,024xD	260 - 320	0,007	0,008	0,010	0,013	0,017	0,023	0,029	0,033	0,042	0,051	0,070	0,089	0,105	0,138	0,167
	K3	●	●	●	0,014xD	0,024xD	260 - 320	0,006	0,007	0,008	0,011	0,014	0,019	0,024	0,028	0,035	0,042	0,058	0,074	0,087	0,114	0,139
H	H1	●	●		0,012xD	0,022xD	200 - 300	0,007	0,009	0,011	0,015	0,018	0,026	0,032	0,037	0,046	0,056	0,077	0,098	0,114	0,151	0,183
	H2		●		0,008xD	0,018xD	130 - 200	0,006	0,008	0,009	0,012	0,015	0,021	0,026	0,030	0,038	0,046	0,063	0,081	0,094	0,124	0,151
	H3		●		0,006xD	0,016xD	70 - 150	0,005	0,007	0,008	0,011	0,014	0,019	0,024	0,027	0,034	0,042	0,058	0,073	0,086	0,113	0,137
	H4	●	●		0,008xD	0,018xD	130 - 200	0,006	0,008	0,009	0,012	0,015	0,021	0,026	0,030	0,038	0,046	0,063	0,081	0,094	0,124	0,151

Schnittwertempfehlung für Eckfräser, Vorschub und Schnittgeschwindigkeit
Recommended cutting values for corner milling cutters, feed and cutting speed

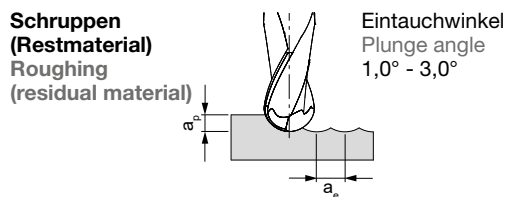

BALLtec SC N Z2

BZG	Kühlung Cooling			a_p [mm]	a_e [mm]	v_c [m/min]	f_z [mm/Zahn] f_z [mm/tooth]												
	Trocken Dry	Luft/MMS Air/MMS	Nass Wet				Fräserdurchmesser [mm] Cutter diameter [mm]												
							1,00	1,50	2,00	2,50	3,00	4,00	5,00	6,00	8,00	10,00	12,00	16,00	20,00
M	M1		●	0,05xD	< 0,25xD	85 - 110	0,018	0,025	0,035	0,044	0,054	0,074	0,094	0,110	0,145	0,176	0,207	0,264	0,304
	M2		●	0,05xD	< 0,25xD	60 - 85	0,015	0,020	0,029	0,037	0,045	0,061	0,078	0,091	0,120	0,146	0,172	0,219	0,252
	N1		●	0,1xD	< 0,3xD	400 - 600	0,022	0,030	0,038	0,045	0,057	0,062	0,082	0,090	0,102	0,120	0,155	0,180	0,205
N	N2		●	0,1xD	< 0,3xD	300 - 580	0,024	0,033	0,042	0,050	0,063	0,068	0,090	0,099	0,112	0,132	0,171	0,198	0,226
	N3	●	●	●	0,1xD	< 0,3xD	300 - 500	0,022	0,030	0,038	0,045	0,057	0,062	0,082	0,090	0,102	0,120	0,155	0,180

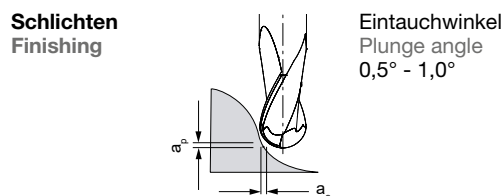

BALLtec SC N Z2

BZG	Kühlung Cooling			a_p [mm]	a_e [mm]	v_c [m/min]	f_z [mm/Zahn] f_z [mm/tooth]												
	Trocken Dry	Luft/MMS Air/MMS	Nass Wet				Fräserdurchmesser [mm] Cutter diameter [mm]												
							1,00	1,50	2,00	2,50	3,00	4,00	5,00	6,00	8,00	10,00	12,00	16,00	20,00
M	M1		●	0,013xD	0,023xD	90 - 120	0,017	0,023	0,033	0,042	0,051	0,070	0,089	0,105	0,138	0,167	0,196	0,251	0,288
	M2		●	0,012xD	0,022xD	70 - 90	0,014	0,019	0,028	0,035	0,042	0,058	0,074	0,087	0,114	0,139	0,163	0,208	0,239
	N1		●	0,015xD	0,025xD	400 - 600	0,022	0,030	0,038	0,045	0,057	0,062	0,082	0,090	0,102	0,120	0,155	0,180	0,205
N	N2		●	0,015xD	0,025xD	300 - 580	0,024	0,033	0,042	0,050	0,063	0,068	0,090	0,099	0,112	0,132	0,171	0,198	0,226
	N3	●	●	●	0,015xD	0,025xD	300 - 500	0,022	0,030	0,038	0,045	0,057	0,062	0,082	0,090	0,102	0,120	0,155	0,180

* Angegebene Schnittdaten sind als Richtwert zu sehen, welche durch Versuche für jeden Anwendungsfall separat optimiert werden können.
* Recommended cutting data has to be seen as a reference which can be optimised for each application through trials separately.

Schnittwertempfehlung für Eckfräser, Vorschub und Schnittgeschwindigkeit
Recommended cutting values for corner milling cutters, feed and cutting speed

Schruppen
 Roughing

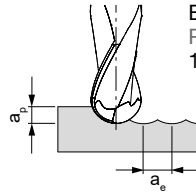

Eintauchwinkel
 Plunge angle
 1,0° - 3,0°

BALLtec SC Graphite Z2

BZG	Kühlung Cooling			APMX [mm]	a_e [mm]	v_c [m/min]	f_z [mm/Zahn] f_z [mm/tooth]													
	Trocken Dry	Luft/MMS Air/MMS	Nass Wet				Fräserdurchmesser [mm] Cutter diameter [mm]													
							0,40	0,50	0,60	0,80	1,00	1,20	1,50	2,00	3,00	4,00	5,00	6,00	8,00	10,00
N N4	●	●	●	0,2xD	0,3xD	400 - 600	0,016	0,018	0,019	0,020	0,022	0,030	0,038	0,045	0,057	0,062	0,082	0,090	0,102	0,120

Schlichten
 (3D, Abzeilen)
 Finishing
 (3D, line-off)

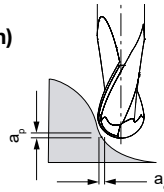

BALLtec SC Graphite Z2

BZG	Kühlung Cooling			APMX [mm]	a_e [mm]	v_c [m/min]	f_z [mm/Zahn] f_z [mm/tooth]													
	Trocken Dry	Luft/MMS Air/MMS	Nass Wet				Fräserdurchmesser [mm] Cutter diameter [mm]													
							0,40	0,50	0,60	0,80	1,00	1,20	1,50	2,00	3,00	4,00	5,00	6,00	8,00	10,00
N N4	●	●	●	0,015xD	0,025xD	600 - 800	0,016	0,018	0,019	0,020	0,022	0,030	0,038	0,045	0,057	0,062	0,082	0,090	0,102	0,120

Schnittwertempfehlung für Eckfräser, Vorschub und Schnittgeschwindigkeit
Recommended cutting values for corner milling cutters, feed and cutting speed

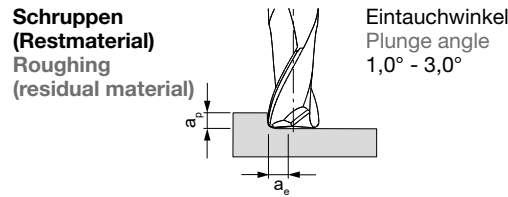

TORROtec SC Universal Z2

BZG	Kühlung Cooling			APMX [mm]	a _e [mm]	v _c [m/min]	f _z [mm/Zahn] f _z [mm/tooth]												
	Trocken Dry	Luft/MMS Air/MMS	Nass Wet				Fräserdurchmesser [mm] Cutter diameter [mm]												
							0,40	0,50	0,60	0,80	1,00	1,50	1,80	2,00	2,50	3,00	4,00	5,00	6,00
P1	●	●	●	0,15xD	0,45xD	240 - 300	0,008	0,010	0,012	0,016	0,020	0,028	0,035	0,040	0,050	0,061	0,084	0,107	0,125
P2	●	●	●	0,15xD	0,45xD	240 - 300	0,008	0,010	0,012	0,016	0,020	0,028	0,035	0,040	0,050	0,061	0,084	0,107	0,125
P3	●	●	●	0,15xD	0,45xD	220 - 300	0,008	0,010	0,011	0,015	0,019	0,027	0,033	0,038	0,048	0,058	0,080	0,102	0,119
P4		●	●	0,15xD	0,45xD	240 - 280	0,008	0,010	0,012	0,016	0,020	0,028	0,035	0,040	0,050	0,061	0,084	0,107	0,125
P5		●	●	0,15xD	0,45xD	200 - 280	0,007	0,009	0,011	0,014	0,018	0,025	0,031	0,035	0,044	0,054	0,074	0,094	0,110
M1			●	0,1xD	0,4xD	85 - 110	0,007	0,009	0,011	0,014	0,018	0,025	0,031	0,035	0,044	0,054	0,074	0,094	0,110
M2			●	0,1xD	0,4xD	60 - 85	0,006	0,007	0,009	0,012	0,015	0,020	0,026	0,029	0,037	0,045	0,061	0,078	0,091
K1	●	●	●	0,15xD	0,55xD	250 - 300	0,010	0,012	0,014	0,019	0,024	0,034	0,042	0,048	0,060	0,073	0,101	0,128	0,150
K2	●	●	●	0,15xD	0,55xD	240 - 300	0,008	0,010	0,012	0,016	0,020	0,028	0,035	0,040	0,050	0,061	0,084	0,107	0,125
K3	●	●	●	0,15xD	0,55xD	240 - 300	0,006	0,007	0,009	0,012	0,015	0,020	0,026	0,029	0,037	0,045	0,061	0,078	0,091
H1	●	●		0,06xD	0,35xD	140 - 240	0,006	0,007	0,009	0,012	0,015	0,020	0,026	0,029	0,037	0,045	0,061	0,078	0,091
H2		●		0,025xD	0,25xD	100 - 140	0,003	0,004	0,005	0,006	0,008	0,011	0,014	0,016	0,020	0,024	0,034	0,043	0,050

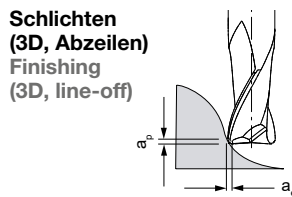

TORROtec SC Universal Z2

BZG	Kühlung Cooling			APMX [mm]	a _e [mm]	v _c [m/min]	f _z [mm/Zahn] f _z [mm/tooth]												
	Trocken Dry	Luft/MMS Air/MMS	Nass Wet				Fräserdurchmesser [mm] Cutter diameter [mm]												
							0,40	0,50	0,60	0,80	1,00	1,50	1,80	2,00	2,50	3,00	4,00	5,00	6,00
P1	●	●	●	0,012xD	0,022xD	280 - 340	0,008	0,010	0,011	0,015	0,019	0,027	0,033	0,038	0,048	0,058	0,080	0,102	0,119
P2	●	●	●	0,012xD	0,022xD	260 - 320	0,008	0,010	0,011	0,015	0,019	0,027	0,033	0,038	0,048	0,058	0,080	0,102	0,119
P3	●	●	●	0,012xD	0,022xD	240 - 320	0,007	0,009	0,011	0,014	0,018	0,025	0,032	0,036	0,045	0,055	0,076	0,097	0,113
P4		●	●	0,012xD	0,022xD	260 - 300	0,008	0,010	0,011	0,015	0,019	0,027	0,033	0,038	0,048	0,058	0,080	0,102	0,119
P5		●	●	0,012xD	0,022xD	220 - 300	0,007	0,008	0,010	0,013	0,017	0,023	0,029	0,033	0,042	0,051	0,070	0,089	0,105
M1			●	0,013xD	0,023xD	90 - 120	0,007	0,008	0,010	0,013	0,017	0,023	0,029	0,033	0,042	0,051	0,070	0,089	0,105
M2			●	0,012xD	0,022xD	70 - 90	0,006	0,007	0,008	0,011	0,014	0,019	0,024	0,028	0,035	0,042	0,058	0,074	0,087
K1	●	●	●	0,012xD	0,022xD	280 - 340	0,008	0,010	0,011	0,015	0,019	0,027	0,033	0,038	0,048	0,058	0,080	0,102	0,119
K2	●	●	●	0,012xD	0,022xD	260 - 320	0,007	0,008	0,010	0,013	0,017	0,023	0,029	0,033	0,042	0,051	0,070	0,089	0,105
K3	●	●	●	0,012xD	0,022xD	260 - 320	0,006	0,007	0,008	0,011	0,014	0,019	0,024	0,028	0,035	0,042	0,058	0,074	0,087
H1	●	●		0,012xD	0,022xD	170 - 250	0,006	0,007	0,009	0,012	0,014	0,020	0,025	0,029	0,036	0,044	0,061	0,077	0,090
H2		●		0,01xD	0,02xD	120 - 170	0,004	0,005	0,006	0,008	0,010	0,013	0,017	0,019	0,024	0,029	0,040	0,051	0,060

* Angegebene Schnittdaten sind als Richtwert zu sehen, welche durch Versuche für jeden Anwendungsfall separat optimiert werden können.
* Recommended cutting data has to be seen as a reference which can be optimised for each application through trials separately.

Schnittwertempfehlung für Eckfräser, Vorschub und Schnittgeschwindigkeit
Recommended cutting values for corner milling cutters, feed and cutting speed

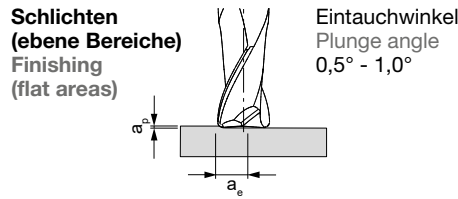

TORROtec SC Universal Z2

BZG	Kühlung Cooling			APMX [mm]	a _e [mm]	v _c [m/min]	f _z [mm/Zahn] f _z [mm/tooth]																
	Trocken Dry	Luft/MMS Air/MMS	Nass Wet				Fräserdurchmesser [mm] Cutter diameter [mm]																
							0,40	0,50	0,60	0,80	1,00	1,50	1,80	2,00	2,50	3,00	4,00	5,00	6,00	8,00	10,00	12,00	
P	P1	●	●	●	0,012xD	0,65xD	190 - 250	0,008	0,010	0,011	0,015	0,019	0,027	0,033	0,038	0,048	0,058	0,080	0,102	0,119	0,157	0,190	0,223
	P2	●	●	●	0,012xD	0,65xD	190 - 250	0,008	0,010	0,011	0,015	0,019	0,027	0,033	0,038	0,048	0,058	0,080	0,102	0,119	0,157	0,190	0,223
	P3	●	●	●	0,012xD	0,65xD	180 - 250	0,007	0,009	0,011	0,014	0,018	0,025	0,032	0,036	0,045	0,055	0,076	0,097	0,113	0,149	0,181	0,212
	P4		●	●	0,012xD	0,65xD	180 - 230	0,008	0,010	0,011	0,015	0,019	0,027	0,033	0,038	0,048	0,058	0,080	0,102	0,119	0,157	0,190	0,223
	P5		●	●	0,012xD	0,65xD	180 - 230	0,007	0,008	0,010	0,013	0,017	0,023	0,029	0,033	0,042	0,051	0,070	0,089	0,105	0,138	0,167	0,196
M	M1			●	0,013xD	0,4xD	90 - 120	0,007	0,008	0,010	0,013	0,017	0,023	0,029	0,033	0,042	0,051	0,070	0,089	0,105	0,138	0,167	0,196
	M2			●	0,012xD	0,4xD	70 - 90	0,006	0,007	0,008	0,011	0,014	0,019	0,024	0,028	0,035	0,042	0,058	0,074	0,087	0,114	0,139	0,163
K	K1	●	●	●	0,012xD	0,65xD	200 - 250	0,008	0,010	0,011	0,015	0,019	0,027	0,033	0,038	0,048	0,058	0,080	0,102	0,119	0,157	0,190	0,223
	K2	●	●	●	0,012xD	0,65xD	190 - 250	0,007	0,008	0,010	0,013	0,017	0,023	0,029	0,033	0,042	0,051	0,070	0,089	0,105	0,138	0,167	0,196
	K3	●	●	●	0,012xD	0,65xD	190 - 250	0,006	0,007	0,008	0,011	0,014	0,019	0,024	0,028	0,035	0,042	0,058	0,074	0,087	0,114	0,139	0,163
H	H1	●	●		0,012xD	0,65xD	120 - 200	0,006	0,007	0,009	0,012	0,014	0,020	0,025	0,029	0,036	0,044	0,061	0,077	0,090	0,119	0,144	0,170
	H2		●		0,01xD	0,65xD	80 - 120	0,004	0,005	0,006	0,008	0,010	0,013	0,017	0,019	0,024	0,029	0,040	0,051	0,060	0,079	0,096	0,113

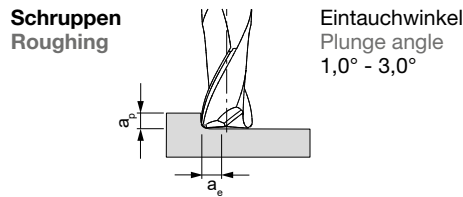

TORROtec SC Hardened Z2

BZG	Kühlung Cooling			APMX [mm]	a _e [mm]	v _c [m/min]	f _z [mm/Zahn] f _z [mm/tooth]																
	Trocken Dry	Luft/MMS Air/MMS	Nass Wet				Fräserdurchmesser [mm] Cutter diameter [mm]																
							0,40	0,50	0,60	0,80	1,00	1,50	1,80	2,00	2,50	3,00	4,00	5,00	6,00				
P	P1	●	●	●	0,15xD	0,45xD	240 - 300	0,008	0,010	0,012	0,016	0,020	0,028	0,035	0,040	0,050	0,061	0,084	0,107	0,125			
	P2	●	●	●	0,15xD	0,45xD	240 - 300	0,008	0,010	0,012	0,016	0,020	0,028	0,035	0,040	0,050	0,061	0,084	0,107	0,125			
	P3	●	●	●	0,15xD	0,45xD	220 - 300	0,008	0,010	0,011	0,015	0,019	0,027	0,033	0,038	0,048	0,058	0,080	0,102	0,119			
	P4		●	●	0,15xD	0,45xD	240 - 280	0,008	0,010	0,012	0,016	0,020	0,028	0,035	0,040	0,050	0,061	0,084	0,107	0,125			
	P5		●	●	0,15xD	0,45xD	200 - 280	0,007	0,009	0,011	0,014	0,018	0,025	0,031	0,035	0,044	0,054	0,074	0,094	0,110			
K	K1	●	●	●	0,15xD	0,55xD	250 - 300	0,010	0,012	0,014	0,019	0,024	0,034	0,042	0,048	0,060	0,073	0,101	0,128	0,150			
	K2	●	●	●	0,15xD	0,55xD	240 - 300	0,008	0,010	0,012	0,016	0,020	0,028	0,035	0,040	0,050	0,061	0,084	0,107	0,125			
	K3	●	●	●	0,15xD	0,55xD	240 - 300	0,006	0,007	0,009	0,012	0,015	0,020	0,026	0,029	0,037	0,045	0,061	0,078	0,091			
H	H1	●	●		0,06xD	0,35xD	180 - 250	0,006	0,007	0,009	0,012	0,015	0,020	0,026	0,029	0,037	0,045	0,061	0,078	0,091			
	H2		●		0,025xD	0,25xD	140 - 180	0,003	0,004	0,005	0,006	0,008	0,011	0,014	0,016	0,020	0,024	0,034	0,043	0,050			

Schnittwertempfehlung für Eckfräser, Vorschub und Schnittgeschwindigkeit
Recommended cutting values for corner milling cutters, feed and cutting speed

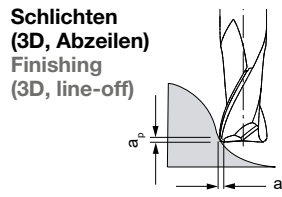

TORROtec SC Hardened Z2

BZG	Kühlung Cooling			APMX [mm]	a _e [mm]	v _c [m/min]	f _z [mm/Zahn] f _z [mm/tooth]												
	Trocken Dry	Luft/MMS Air/MMS	Nass Wet				Fräserdurchmesser [mm] Cutter diameter [mm]												
							0,40	0,50	0,60	0,80	1,00	1,50	1,80	2,00	2,50	3,00	4,00	5,00	6,00
P1	●	●	●	0,012xD	0,022xD	280 - 340	0,008	0,010	0,011	0,015	0,019	0,027	0,033	0,038	0,048	0,058	0,080	0,102	0,119
P2	●	●	●	0,012xD	0,022xD	260 - 320	0,008	0,010	0,011	0,015	0,019	0,027	0,033	0,038	0,048	0,058	0,080	0,102	0,119
P3	●	●	●	0,012xD	0,022xD	240 - 320	0,007	0,009	0,011	0,014	0,018	0,025	0,032	0,036	0,045	0,055	0,076	0,097	0,113
P4		●	●	0,012xD	0,022xD	260 - 300	0,008	0,010	0,011	0,015	0,019	0,027	0,033	0,038	0,048	0,058	0,080	0,102	0,119
P5		●	●	0,012xD	0,022xD	220 - 300	0,007	0,008	0,010	0,013	0,017	0,023	0,029	0,033	0,042	0,051	0,070	0,089	0,105
K1	●	●	●	0,012xD	0,022xD	280 - 340	0,008	0,010	0,011	0,015	0,019	0,027	0,033	0,038	0,048	0,058	0,080	0,102	0,119
K2	●	●	●	0,012xD	0,022xD	260 - 320	0,007	0,008	0,010	0,013	0,017	0,023	0,029	0,033	0,042	0,051	0,070	0,089	0,105
K3	●	●	●	0,012xD	0,022xD	260 - 320	0,006	0,007	0,008	0,011	0,014	0,019	0,024	0,028	0,035	0,042	0,058	0,074	0,087
H1	●	●		0,012xD	0,022xD	190 - 250	0,006	0,007	0,009	0,012	0,014	0,020	0,025	0,029	0,036	0,044	0,061	0,077	0,090
H2		●		0,01xD	0,02xD	150 - 190	0,004	0,005	0,006	0,008	0,010	0,013	0,017	0,019	0,024	0,029	0,040	0,051	0,060
H3		●		0,007xD	0,017xD	80 - 150	0,003	0,004	0,005	0,007	0,008	0,012	0,015	0,017	0,021	0,025	0,035	0,045	0,052
H4	●	●		0,008xD	0,018xD	150 - 200	0,004	0,005	0,006	0,008	0,010	0,013	0,017	0,019	0,024	0,029	0,040	0,051	0,060

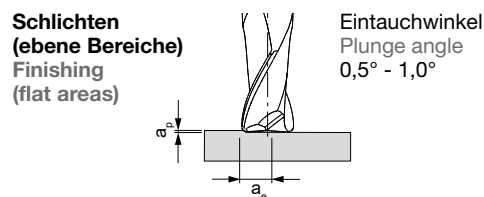

TORROtec SC Hardened Z2

BZG	Kühlung Cooling			APMX [mm]	a _e [mm]	v _c [m/min]	f _z [mm/Zahn] f _z [mm/tooth]												
	Trocken Dry	Luft/MMS Air/MMS	Nass Wet				Fräserdurchmesser [mm] Cutter diameter [mm]												
							0,40	0,50	0,60	0,80	1,00	1,50	1,80	2,00	2,50	3,00	4,00	5,00	6,00
P1	●	●	●	0,012xD	0,65xD	190 - 250	0,008	0,010	0,011	0,015	0,019	0,027	0,033	0,038	0,048	0,058	0,080	0,102	0,119
P2	●	●	●	0,012xD	0,65xD	190 - 250	0,008	0,010	0,011	0,015	0,019	0,027	0,033	0,038	0,048	0,058	0,080	0,102	0,119
P3	●	●	●	0,012xD	0,65xD	180 - 250	0,007	0,009	0,011	0,014	0,018	0,025	0,032	0,036	0,045	0,055	0,076	0,097	0,113
P4		●	●	0,012xD	0,65xD	180 - 230	0,008	0,010	0,011	0,015	0,019	0,027	0,033	0,038	0,048	0,058	0,080	0,102	0,119
P5		●	●	0,012xD	0,65xD	180 - 230	0,007	0,008	0,010	0,013	0,017	0,023	0,029	0,033	0,042	0,051	0,070	0,089	0,105
K1	●	●	●	0,012xD	0,65xD	200 - 250	0,008	0,010	0,011	0,015	0,019	0,027	0,033	0,038	0,048	0,058	0,080	0,102	0,119
K2	●	●	●	0,012xD	0,65xD	190 - 250	0,007	0,008	0,010	0,013	0,017	0,023	0,029	0,033	0,042	0,051	0,070	0,089	0,105
K3	●	●	●	0,012xD	0,65xD	190 - 250	0,006	0,007	0,008	0,011	0,014	0,019	0,024	0,028	0,035	0,042	0,058	0,074	0,087
H1	●	●		0,012xD	0,65xD	120 - 200	0,006	0,007	0,009	0,012	0,014	0,020	0,025	0,029	0,036	0,044	0,061	0,077	0,090
H2		●		0,01xD	0,65xD	80 - 120	0,004	0,005	0,006	0,008	0,010	0,013	0,017	0,019	0,024	0,029	0,040	0,051	0,060
H3		●		0,006xD	0,45xD	35 - 80	0,003	0,004	0,005	0,007	0,008	0,012	0,015	0,017	0,021	0,025	0,035	0,045	0,052
H4	●	●		0,008xD	0,55xD	80 - 120	0,004	0,005	0,006	0,008	0,010	0,013	0,017	0,019	0,024	0,029	0,040	0,051	0,060

* Angegebene Schnittdaten sind als Richtwert zu sehen, welche durch Versuche für jeden Anwendungsfall separat optimiert werden können.
* Recommended cutting data has to be seen as a reference which can be optimised for each application through trials separately.

Schnittwertempfehlung für Eckfräser, Vorschub und Schnittgeschwindigkeit
Recommended cutting values for corner milling cutters, feed and cutting speed

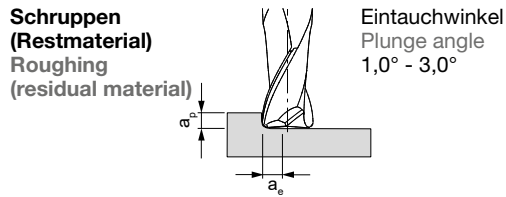

TORROtec SC N Z2

BZG	Kühlung Cooling			APMX [mm]	a_e [mm]	v_c [m/min]	f_z [mm/Zahn] f_z [mm/tooth]									
	Trocken Dry	Luft/MMS Air/MMS	Nass Wet				Fräserdurchmesser [mm] Cutter diameter [mm]									
							2,00	3,00	4,00	5,00	6,00	8,00	10,00	12,00	16,00	20,00
M	M1		●	0,1xD	0,4xD	85 - 110	0,035	0,054	0,074	0,094	0,110	0,145	0,176	0,207	0,264	0,304
	M2		●	0,1xD	0,4xD	60 - 85	0,029	0,045	0,061	0,078	0,091	0,120	0,146	0,172	0,219	0,252
N	N1		●	0,15xD	0,6xD	400 - 600	0,038	0,057	0,062	0,082	0,090	0,102	0,120	0,155	0,180	0,205
	N2		●	0,15xD	0,6xD	300 - 580	0,042	0,063	0,068	0,090	0,099	0,112	0,132	0,171	0,198	0,226
	N3	●	●	●	0,15xD	0,6xD	300 - 500	0,038	0,057	0,062	0,082	0,090	0,102	0,120	0,155	0,180

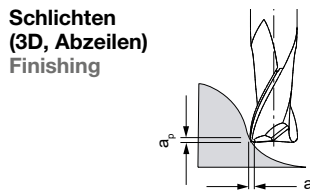

TORROtec SC N Z2

BZG	Kühlung Cooling			APMX [mm]	a_e [mm]	v_c [m/min]	f_z [mm/Zahn] f_z [mm/tooth]									
	Trocken Dry	Luft/MMS Air/MMS	Nass Wet				Fräserdurchmesser [mm] Cutter diameter [mm]									
							2,00	3,00	4,00	5,00	6,00	8,00	10,00	12,00	16,00	20,00
M	M1		●	0,013xD	0,023xD	90 - 120	0,033	0,051	0,070	0,089	0,105	0,138	0,167	0,196	0,251	0,288
	M2		●	0,012xD	0,022xD	70 - 90	0,028	0,042	0,058	0,074	0,087	0,114	0,139	0,163	0,208	0,239
N	N1		●	0,015xD	0,025xD	400 - 600	0,038	0,057	0,062	0,082	0,090	0,102	0,120	0,155	0,180	0,205
	N2		●	0,015xD	0,025xD	300 - 580	0,042	0,063	0,068	0,090	0,099	0,112	0,132	0,171	0,198	0,226
	N3	●	●	●	0,015xD	0,025xD	300 - 500	0,038	0,057	0,062	0,082	0,090	0,102	0,120	0,155	0,180

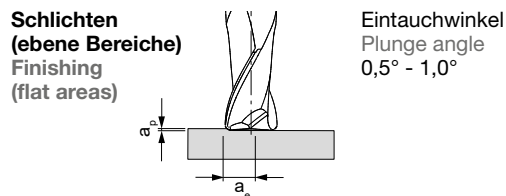

TORROtec SC N

BZG	Kühlung Cooling			APMX [mm]	a_e [mm]	v_c [m/min]	f_z [mm/Zahn] f_z [mm/tooth]									
	Trocken Dry	Luft/MMS Air/MMS	Nass Wet				Fräserdurchmesser [mm] Cutter diameter [mm]									
							2,00	3,00	4,00	5,00	6,00	8,00	10,00	12,00	16,00	20,00
M	M1		●	0,013xD	0,4xD	90 - 120	0,033	0,051	0,070	0,089	0,105	0,138	0,167	0,196	0,251	0,288
	M2		●	0,012xD	0,4xD	70 - 90	0,028	0,042	0,058	0,074	0,087	0,114	0,139	0,163	0,208	0,239
N	N1		●	0,015xD	0,6xD	380 - 600	0,038	0,057	0,062	0,082	0,090	0,102	0,120	0,155	0,180	0,205
	N2		●	0,015xD	0,6xD	300 - 580	0,042	0,063	0,068	0,090	0,099	0,112	0,132	0,171	0,198	0,226
	N3	●	●	●	0,015xD	0,6xD	300 - 500	0,038	0,057	0,062	0,082	0,090	0,102	0,120	0,155	0,180

Schnittwertempfehlung für Eckfräser, Vorschub und Schnittgeschwindigkeit
Recommended cutting values for corner milling cutters, feed and cutting speed

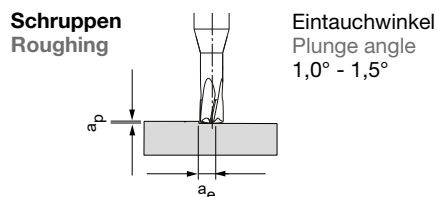

FEEDtec SC Universal Z4

BZG	Kühlung Cooling			APMX [mm]	a _e [mm]	v _c [m/min]	f _z [mm/Zahn] f _z [mm/tooth]								
	Trocken Dry	Luft/MMS Air/MMS	Nass Wet				Fräserdurchmesser [mm] Cutter diameter [mm]								
							2,00	3,00	4,00	5,00	6,00	8,00	10,00	12,00	16,00
P1	●	●		0,038xD	0,6xD	150 - 250	0,100	0,150	0,200	0,225	0,287	0,400	0,550	0,625	0,625
P2	●	●		0,038xD	0,6xD	150 - 250	0,100	0,150	0,200	0,225	0,287	0,400	0,550	0,625	0,625
P3	●	●		0,038xD	0,6xD	120 - 220	0,100	0,150	0,200	0,225	0,287	0,325	0,325	0,475	0,475
P4		●	●	0,038xD	0,6xD	90 - 110	0,100	0,150	0,200	0,225	0,287	0,325	0,325	0,475	0,475
P5		●	●	0,038xD	0,6xD	70 - 110	0,100	0,150	0,200	0,225	0,287	0,325	0,325	0,475	0,475
K1	●	●		0,038xD	0,7xD	250 - 300	0,100	0,150	0,200	0,225	0,287	0,400	0,550	0,625	0,625
K2	●	●		0,038xD	0,7xD	150 - 300	0,100	0,150	0,200	0,225	0,287	0,400	0,550	0,625	0,625
K3	●	●		0,038xD	0,7xD	150 - 200	0,100	0,150	0,200	0,225	0,287	0,325	0,325	0,475	0,475
H1	●	●		0,035xD	0,7xD	120 - 190	0,100	0,150	0,200	0,225	0,287	0,400	0,550	0,625	0,625
H2	●	●		0,028xD	0,55xD	100 - 120	0,100	0,150	0,175	0,200	0,250	0,250	0,300	0,350	0,400

FEEDtec Universal Z4

Programmierdaten CAM data		
Ø Fräser [mm] Ø End mill cutter [mm]	Abmessungen [mm] Dimensions [mm]	
	R _{th}	b
3	0,20	0,75
4	0,30	1,00
5	0,40	1,35
6	0,50	1,50
8	0,70	2,10
10	0,85	2,50
12	1,00	3,10

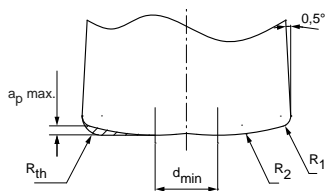

* Angegebene Schnittdaten sind als Richtwert zu sehen, welche durch Versuche für jeden Anwendungsfall separat optimiert werden können.
* Recommended cutting data has to be seen as a reference which can be optimised for each application through trials separately.

Schnittwertempfehlung für Eckfräser, Vorschub und Schnittgeschwindigkeit
Recommended cutting values for corner milling cutters, feed and cutting speed

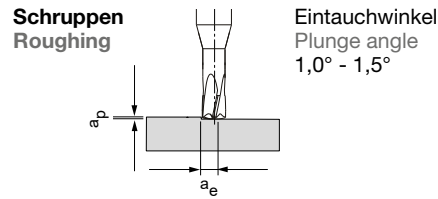

FEEDtec SC Hardened Z4/Z6

BZG	Kühlung Cooling			APMX [mm]	a _e [mm]	v _c [m/min]	f _z [mm/Zahn] f _z [mm/tooth]								
	Trocken Dry	Luft/MMS Air/MMS	Nass Wet				Fräserdurchmesser [mm] Cutter diameter [mm]								
							2,00	3,00	4,00	5,00	6,00	8,00	10,00	12,00	
P	P1	●	●		0,042xD	0,6xD	240 - 340	0,100	0,130	0,180	0,210	0,250	0,350	0,460	0,580
	P2	●	●		0,042xD	0,6xD	240 - 320	0,100	0,130	0,180	0,210	0,250	0,350	0,450	0,560
	P3	●	●		0,042xD	0,6xD	240 - 340	0,100	0,130	0,170	0,200	0,240	0,340	0,430	0,520
	P4		●	●	0,042xD	0,6xD	160 - 200	0,100	0,130	0,180	0,210	0,250	0,350	0,400	0,500
	P5		●	●	0,042xD	0,6xD	160 - 220	0,100	0,110	0,160	0,200	0,230	0,330	0,380	0,470
K	K1	●	●		0,042xD	0,7xD	250 - 300	0,100	0,130	0,180	0,210	0,250	0,350	0,460	0,580
	K2	●	●		0,042xD	0,7xD	200 - 300	0,080	0,110	0,160	0,190	0,230	0,310	0,430	0,520
	K3	●	●		0,042xD	0,7xD	200 - 270	0,100	0,130	0,180	0,210	0,250	0,350	0,450	0,560
H	H1	●	●		0,042xD	0,7xD	150 - 250	0,071	0,103	0,135	0,170	0,210	0,280	0,350	0,420
	H2		●		0,04xD	0,55xD	110 - 150	0,062	0,083	0,106	0,142	0,172	0,220	0,280	0,330
	H3		●		0,03xD	0,4xD	60 - 120	0,044	0,065	0,086	0,109	0,131	0,170	0,210	0,245
	H4	●	●		0,035xD	0,45xD	90 - 120	0,055	0,070	0,090	0,120	0,140	0,180	0,220	0,250

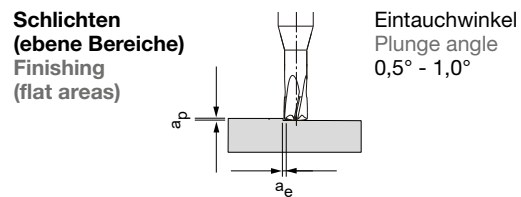

FEEDtec SC Hardened Z4/Z6

BZG	Kühlung Cooling			APMX [mm]	a _e [mm]	v _c [m/min]	f _z [mm/Zahn] f _z [mm/tooth]								
	Trocken Dry	Luft/MMS Air/MMS	Nass Wet				Fräserdurchmesser [mm] Cutter diameter [mm]								
							2,00	3,00	4,00	5,00	6,00	8,00	10,00	12,00	
H	H2		●		0,008xD	0,08xD	160 - 185	0,040	0,048	0,058	0,072	0,105	0,144	0,182	0,210
	H3		●		0,004xD	0,072xD	110 - 170	0,028	0,037	0,046	0,063	0,084	0,110	0,148	0,174
	H4	●	●		0,006xD	0,08xD	160 - 180	0,038	0,042	0,055	0,070	0,092	0,128	0,160	0,190

FEEDtec SC Hardened Z4/Z6

Programmierdaten CAM data		
Ø Fräser [mm] Ø End mill cutter [mm]	Abmessungen [mm] Dimensions [mm]	
	R _{th}	b
2	0,18	0,7
3	0,28	1,05
4	0,37	1,4
5	0,46	1,75
6	0,55	2,1
8	0,74	2,8
10	0,92	3,5
12	1,11	4,2

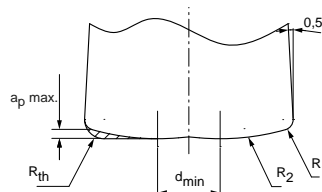

Schnittwertempfehlung für Eckfräser, Vorschub und Schnittgeschwindigkeit
Recommended cutting values for corner milling cutters, feed and cutting speed

Schruppen
Roughing

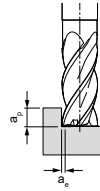

Eintauchwinkel
Plunge angle
1,0° - 3,0°

UNItec Pro H long neck FR Z4,
UNItec Pro H overlength neck FR Z4

BZG	Kühlung Cooling			APMX [mm]	a _e [mm]	v _c [m/min]	f _z [mm/Zahn] f _z [mm/tooth]								
	Trocken Dry	Luft/MMS Air/MMS	Nass Wet				Fräserdurchmesser [mm] Cutter diameter [mm]								
							4,00	5,00	6,00	8,00	10,00	12,00	16,00	20,00	
P	P1	●	●	●	0,5xD	0,08xD	160 - 200	0,032	0,040	0,048	0,055	0,075	0,095	0,110	0,140
	P2	●	●	●	0,5xD	0,08xD	150 - 190	0,032	0,040	0,048	0,055	0,075	0,095	0,110	0,140
	P3	●	●	●	0,5xD	0,08xD	130 - 190	0,032	0,040	0,048	0,055	0,075	0,095	0,110	0,140
	P4		●	●	0,5xD	0,07xD	130 - 150	0,027	0,034	0,041	0,047	0,064	0,081	0,094	0,119
	P5		●	●	0,5xD	0,07xD	130 - 160	0,027	0,034	0,041	0,047	0,064	0,081	0,094	0,119
H	H1	●	●		0,5xD	0,02xD	80 - 125	0,027	0,034	0,041	0,047	0,064	0,081	0,094	0,119
	H2		●		0,5xD	0,012xD	60 - 80	0,019	0,024	0,029	0,033	0,045	0,057	0,066	0,084

Schlichten
Finishing

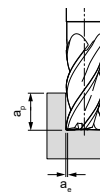

Eintauchwinkel
Plunge angle
0,5° - 1,0°

UNItec Pro H long neck FR Z4,
UNItec Pro H overlength neck FR Z4

BZG	Kühlung Cooling			APMX [mm]	a _e [mm]	v _c [m/min]	f _z [mm/Zahn] f _z [mm/tooth]								
	Trocken Dry	Luft/MMS Air/MMS	Nass Wet				Fräserdurchmesser [mm] Cutter diameter [mm]								
							4,00	5,00	6,00	8,00	10,00	12,00	16,00	20,00	
P	P1	●	●	●	1xD	0,02xD	180 - 220	0,025	0,030	0,040	0,050	0,065	0,075	0,090	0,105
	P2	●	●	●	1xD	0,02xD	160 - 200	0,025	0,030	0,040	0,050	0,065	0,075	0,090	0,105
	P3	●	●	●	1xD	0,02xD	140 - 200	0,025	0,030	0,040	0,050	0,065	0,075	0,090	0,105
	P4		●	●	1xD	0,02xD	140 - 160	0,021	0,026	0,034	0,043	0,055	0,064	0,077	0,089
	P5		●	●	1xD	0,02xD	140 - 170	0,021	0,026	0,034	0,043	0,055	0,064	0,077	0,089
H	H1	●	●		1xD	0,015xD	90 - 130	0,021	0,026	0,034	0,043	0,055	0,064	0,077	0,089
	H2		●		1xD	0,008xD	70 - 90	0,015	0,018	0,024	0,030	0,039	0,045	0,054	0,063

* Angegebene Schnittdaten sind als Richtwert zu sehen, welche durch Versuche für jeden Anwendungsfall separat optimiert werden können.
* Recommended cutting data has to be seen as a reference which can be optimised for each application through trials separately.

Schnittwertempfehlung für Eckfräser, Vorschub und Schnittgeschwindigkeit
Recommended cutting values for corner milling cutters, feed and cutting speed

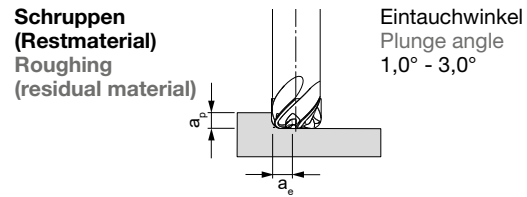

UNItec Pro Hardened Superfinish FR Z5

BZG	Kühlung Cooling			APMX [mm]	a _e [mm]	v _c [m/min]	f _z [mm/Zahn] f _z [mm/tooth]						
	Trocken Dry	Luft/MMS Air/MMS	Nass Wet				Fräserdurchmesser [mm] Cutter diameter [mm]						
							4	5	6	8	10	12	
P	P1	●	●	●	0,15xD	0,35xD	210 - 270	0,080	0,090	0,100	0,120	0,150	0,180
	P2	●	●	●	0,15xD	0,35xD	210 - 270	0,080	0,090	0,100	0,120	0,150	0,180
	P3	●	●	●	0,15xD	0,35xD	220 - 270	0,080	0,090	0,100	0,120	0,150	0,180
	P4		●	●	0,15xD	0,35xD	200 - 250	0,070	0,080	0,090	0,110	0,130	0,160
	P5		●	●	0,15xD	0,35xD	200 - 250	0,070	0,080	0,090	0,110	0,130	0,160
K	K1	●	●	●	0,15xD	0,4xD	220 - 270	0,080	0,090	0,100	0,120	0,150	0,180
	K2	●	●	●	0,15xD	0,4xD	200 - 270	0,080	0,090	0,100	0,120	0,150	0,180
	K3	●	●	●	0,15xD	0,4xD	200 - 270	0,080	0,090	0,100	0,120	0,150	0,180
H	H1	●	●		0,06xD	0,35xD	180 - 250	0,060	0,080	0,090	0,110	0,130	0,160
	H2		●		0,025xD	0,25xD	140 - 180	0,040	0,060	0,070	0,085	0,095	0,120
	H3		●										
	H4	●	●										

**Schlichten
(3D, Abzeilen)**
Finishing
(3D, line-off)

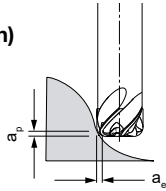

**Schlichten
(ebene Bereiche)**
Finishing
(flat areas)

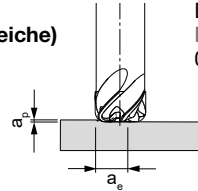

Eintauchwinkel
Plunge angle
0,5° - 1,0°

APMX [mm]	a _e [mm]	v _c [m/min]	f _z [mm/Zahn] f _z [mm/tooth]						APMX [mm]	a _e [mm]	v _c [m/min]	f _z [mm/Zahn] f _z [mm/tooth]					
			Fräserdurchmesser [mm] Cutter diameter [mm]									Fräserdurchmesser [mm] Cutter diameter [mm]					
			4	5	6	8	10	12				4	5	6	8	10	12
0,012xD	0,022xD	250 - 320	0,050	0,060	0,080	0,090	0,110	0,130	0,012xD	0,65xD	190 - 250	0,050	0,060	0,080	0,090	0,110	0,130
0,012xD	0,022xD	250 - 320	0,050	0,060	0,080	0,090	0,110	0,130	0,012xD	0,65xD	190 - 250	0,050	0,060	0,080	0,090	0,110	0,130
0,012xD	0,022xD	240 - 320	0,050	0,060	0,080	0,090	0,110	0,130	0,012xD	0,65xD	180 - 250	0,050	0,060	0,080	0,090	0,110	0,130
0,012xD	0,022xD	240 - 300	0,050	0,060	0,080	0,090	0,110	0,130	0,012xD	0,65xD	180 - 230	0,050	0,060	0,080	0,090	0,110	0,130
0,012xD	0,022xD	240 - 300	0,050	0,060	0,080	0,090	0,110	0,130	0,012xD	0,65xD	180 - 230	0,050	0,060	0,080	0,090	0,110	0,130
0,012xD	0,022xD	260 - 320	0,050	0,060	0,080	0,090	0,110	0,130	0,012xD	0,65xD	200 - 250	0,050	0,060	0,080	0,090	0,110	0,130
0,012xD	0,022xD	250 - 320	0,050	0,060	0,080	0,090	0,110	0,130	0,012xD	0,65xD	190 - 250	0,050	0,060	0,080	0,090	0,110	0,130
0,012xD	0,022xD	240 - 320	0,050	0,060	0,080	0,090	0,110	0,130	0,012xD	0,65xD	190 - 250	0,050	0,060	0,080	0,090	0,110	0,130
0,012xD	0,022xD	210 - 300	0,050	0,060	0,080	0,090	0,110	0,130	0,012xD	0,65xD	160 - 230	0,050	0,060	0,080	0,090	0,110	0,130
0,01xD	0,02xD	200 - 270	0,040	0,050	0,070	0,080	0,100	0,120	0,01xD	0,65xD	140 - 200	0,040	0,050	0,070	0,080	0,100	0,120
0,007xD	0,017xD	80 - 220	0,035	0,045	0,060	0,075	0,090	0,110	0,006xD	0,45xD	50 - 140	0,035	0,045	0,060	0,075	0,090	0,110
0,008xD	0,018xD	100 - 180	0,040	0,050	0,070	0,080	0,100	0,120	0,008xD	0,55xD	80 - 140	0,040	0,050	0,070	0,080	0,100	0,120

* Angegebene Schnittdaten sind als Richtwert zu sehen, welche durch Versuche für jeden Anwendungsfall separat optimiert werden können.
* Recommended cutting data has to be seen as a reference which can be optimised for each application through trials separately.

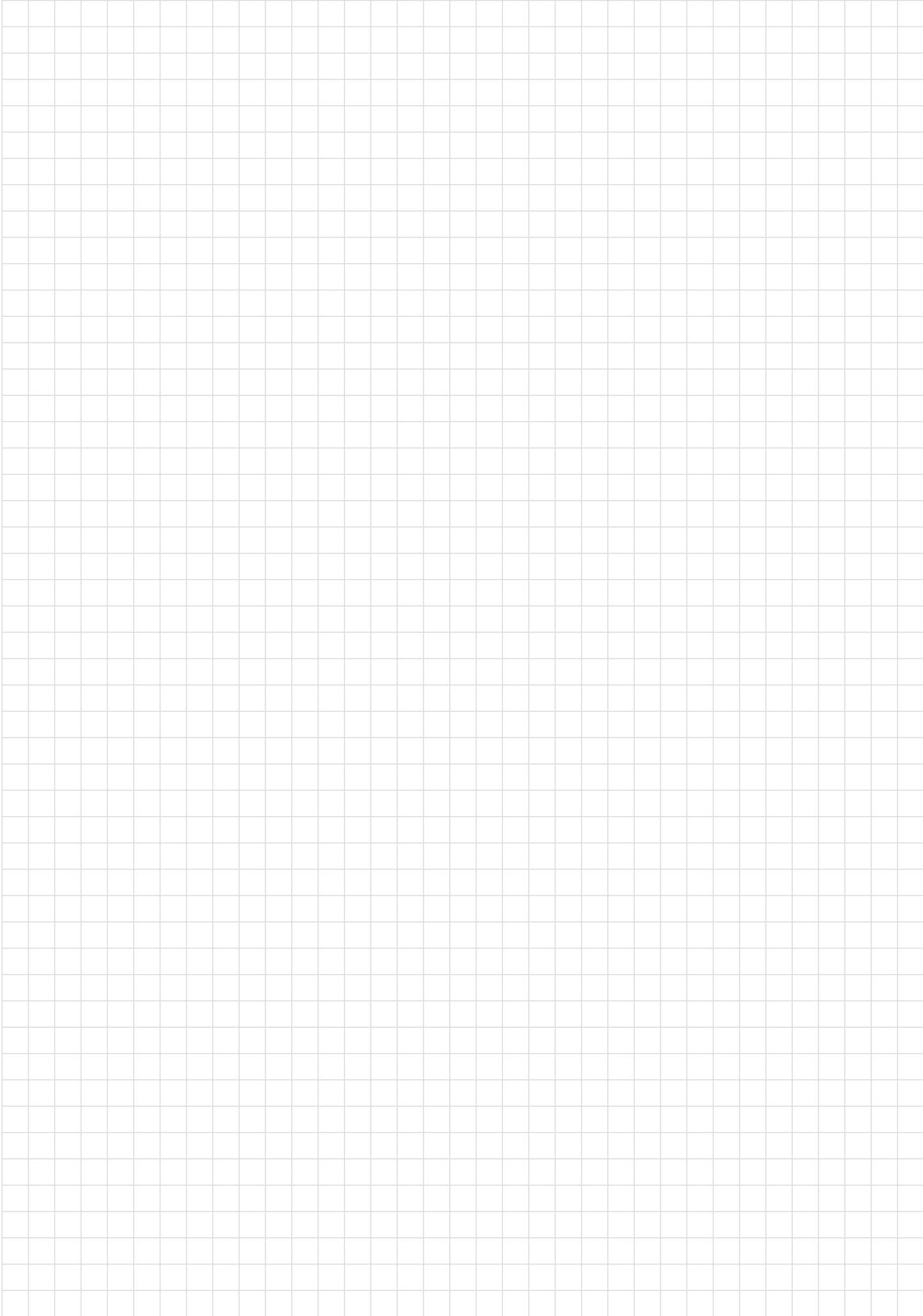

boehlerit

Fasbearbeitung, Entgraten
Chamfering, deburring



Fasbearbeitung, Entgraten Chamfering, deburring	
	UNItec
	
Zähnezahl Amount teeth	Z4
P.1	■
P.2	■
P.3	■
P.4	■
P.5	■
M.1	□
M.2	□
K.1	■
K.2	■
N.1	■
N.2	■
N.3	□

UNItec chamfer 90°

Kurze Ausführung Z4
Execution short Z4

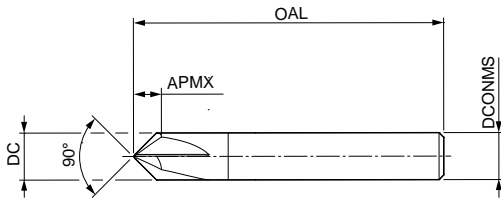

Hard Facts	
Fräserdurchmesser:	4,00 - 20,00 mm
Beschichtung:	TiAlN PVD
Schneidenzahl:	Z = 4
Spitzenwinkel:	90°
Drallwinkel:	0°
Diameter:	4.00 - 20.00 mm
Coating:	TiAlN PVD
Amount/Teeth:	Z = 4
Angle:	90°
Helix angle:	0°

UNItec chamfer 90°		
ISO		
P	P.1	■
	P.2	■
	P.3	■
	P.4	■
	P.5	■
M	M.1	□
	M.2	□
K	K.1	■
	K.2	■
N	N.1	■
	N.2	■
	N.3	□

Artikelbezeichnung Item Code	Bestell-Nr. Ordering No.	Verfügbarkeit Availability	Abmessungen [mm] Dimensions [mm]				ZEFF ^o	Schaft Shank
			DC	DCONMS	OAL	APMX		
UC04.009.054 SH Z4 HA	5162909	●	4,00	4,00	54,00	4,00	4	HA
UC06.012.054 SH Z4 HA	5162910	●	6,00	6,00	54,00	6,00	4	HA
UC08.015.058 SH Z4 HA	5162911	●	8,00	8,00	58,00	8,00	4	HA
UC10.016.066 SH Z4 HA	5162912	●	10,00	10,00	66,00	10,00	4	HA
UC12.018.073 SH Z4 HA	5162913	●	12,00	12,00	73,00	12,00	4	HA
UC16.025.082 SH Z4 HA	5162914	●	16,00	16,00	82,00	16,00	4	HA
UC20.030.092 SH Z4 HA	5162915	⦿	20,00	20,00	92,00	20,00	4	HA

Bestellbeispiel Order example: 1 Stück piece 5162909 oder or UC04.009.054 SH Z4 HA
Genauere Schnittwertempfehlung siehe Seite 292
Detailed cutting recommendations, see page 292

- Verfügbar ab Lager Available from stock
- ⦿ Kurzfristig lieferbar Available at short notice
- Lieferzeit auf Anfrage Delivery time on request

Schnittwertempfehlung für Eckfräser, Vorschub und Schnittgeschwindigkeit
Recommended cutting values for corner milling cutters, feed and cutting speed

Schlichten
 Finishing

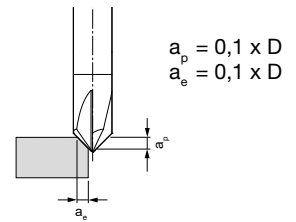

UNitec Chamfer Z4

BZG	Kühlung Cooling			v_c [m/min]	f_z [mm/Zahn] f_z [mm/tooth]							
	MMS/Luft MMS/Air	Trocken Dry	Nass Wet		Fräserdurchmesser [mm] Cutter diameter [mm]							
					4	6	8	10	12	16	20	
P	P1	●	●	●	220 - 265	0,041	0,058	0,075	0,091	0,105	0,132	0,153
	P2	●	●	●	170 - 245	0,041	0,058	0,075	0,091	0,105	0,132	0,153
	P3	●	●	●	135 - 160	0,039	0,055	0,071	0,086	0,100	0,125	0,145
	P4	●		●	110	0,027	0,039	0,050	0,060	0,070	0,088	0,102
	P5			●	110 - 165	0,039	0,056	0,072	0,088	0,102	0,128	0,148
M	M1	●		●	75 - 80	0,024	0,034	0,044	0,053	0,062	0,077	0,089
	M2			●	70 - 75	0,020	0,028	0,036	0,044	0,051	0,064	0,074
K	K1	●	●	●	290	0,068	0,097	0,124	0,151	0,176	0,220	0,255
	K2	●	●	●	120 - 265	0,058	0,082	0,106	0,128	0,149	0,187	0,217
N	N1	●	●	●	1015	0,068	0,097	0,124	0,151	0,176	0,220	0,255
	N2	●	●	●	390 - 675	0,071	0,102	0,131	0,158	0,185	0,231	0,268
	N3	●	●	●	290 - 485	0,054	0,077	0,100	0,121	0,141	0,176	0,204

* Angegebene Schnittdaten sind als Richtwert zu sehen, welche durch Versuche für jeden Anwendungsfall separat optimiert werden können.
 * Recommended cutting data has to be seen as a reference which can be optimised for each application through trials separately.

bilz

boehlerit

Verlängerungen
Extensions
Aufnahmen
Chucks



Vollhartmetall-Verlängerungen für Einschraubwerkzeug
Solid carbide extensions for screw on type milling cutter

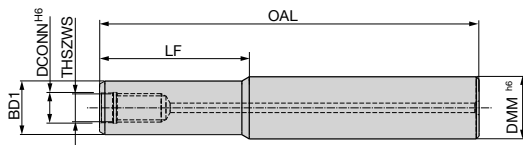

THSZWS	DCONN ^{H6}	BD1	DMM ^{H6}	LF	OAL	Bestellbezeichnung Ordering code	Material-Nr. Material-No.	Verfügbarkeit Availability
4,5	4,8	7,7	10	20	65	Z 10.020 M4,5	5153592	●

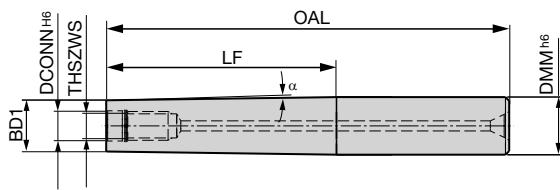

THSZWS	DCONN ^{H6}	BD1	DMM ^{H6}	α	LF	OAL	Bestellbezeichnung Ordering code	Material-Nr. Material-No.	Verfügbarkeit Availability
4,5	4,8	7,7	10	1,65°	40	85	K 10.040 M4,5	5153620	●
4,5	4,8	7,7	10	1,1°	60	105	K 10.060 M4,5	5153854	●
4,5	4,8	7,7	10	0,82°	80	130	K 10.080 M4,5	5153855	●
4,5	4,8	7,7	10	0,66°	100	150	K 10.100 M4,5	5153863	●

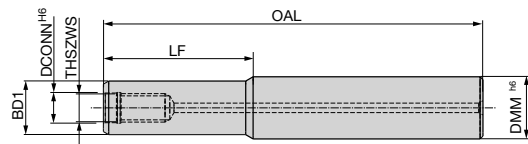

THSZWS	DCONN ^{H6}	BD1	DMM ^{H6}	α	LF	OAL	LBD1	Bestellbezeichnung Ordering code	Material-Nr. Material-No.	Verfügbarkeit Availability
6	6,5	9,5	10	0,72°	20	60	9	Z 10.060 M6	5127650	●
6	6,5	9,5	10	0,36°	40	80	9	Z 10.080 M6	5127652	●
6	6,5	9,5	10	0,24°	60	100	9	Z 10.100 M6	5127653	●
6	6,5	9,5	10	0,18°	80	120	9	Z 10.120 M6	5127655	●

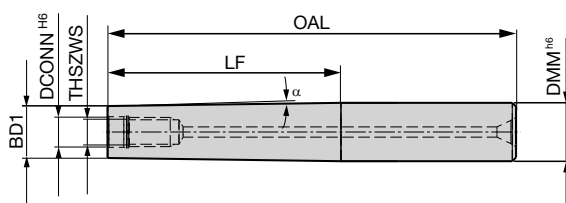

THSZWS	DCONN ^{H6}	BD1	DMM ^{H6}	α	LF	OAL	Bestellbezeichnung Ordering code	Material-Nr. Material-No.	Verfügbarkeit Availability
8	8,5	12,8	16	2,29°	40	95	K 16.040 M8	5087764	●
8	8,5	12,8	16	1,53°	60	115	K 16.060 M8	5088441	●
8	8,5	12,8	16	1,15°	80	135	K 16.080 M8	5088442	●
8	8,5	12,8	16	0,92°	100	155	K 16.100 M8	5088459	●
8	8,5	12,8	16	0,76°	120	175	K 16.120 M8	5088462	●

Bestellbeispiel Order example: 1 Stück piece 5153592 oder or Z 10.020 M4,5

Vollhartmetall-Verlängerungen für Einschraubwerkzeug
Solid carbide extensions for screw on type milling cutter

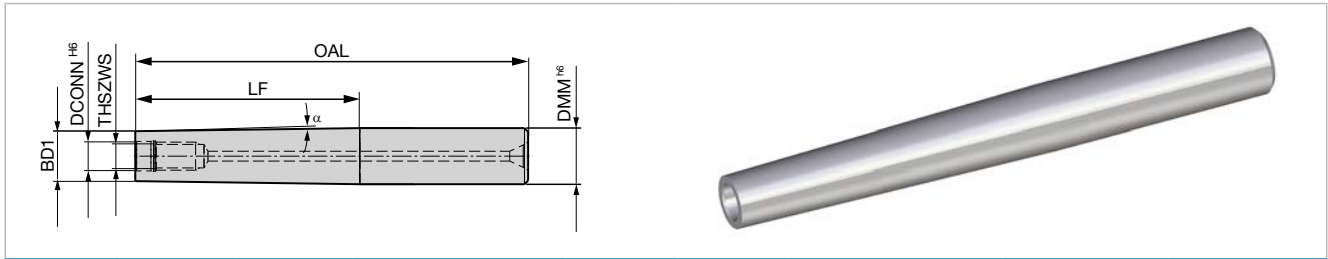

THSZWS	DCONN ^{H6}	BD1	DMM ^{H6}	α	LF	OAL	Bestellbezeichnung Ordering code	Material-Nr. Material-No.	Verfügbarkeit Availability
10	10,5	17,8	20	1,58°	40	100	K 20.040 M10	5088552	●
10	10,5	17,8	20	1,05°	60	120	K 20.060 M10	5088553	●
10	10,5	17,8	20	0,79°	80	140	K 20.080 M10	5088661	●
10	10,5	17,8	20	0,63°	100	160	K 20.100 M10	5088662	●
10	10,5	17,8	20	0,53°	120	180	K 20.120 M10	5088768	●

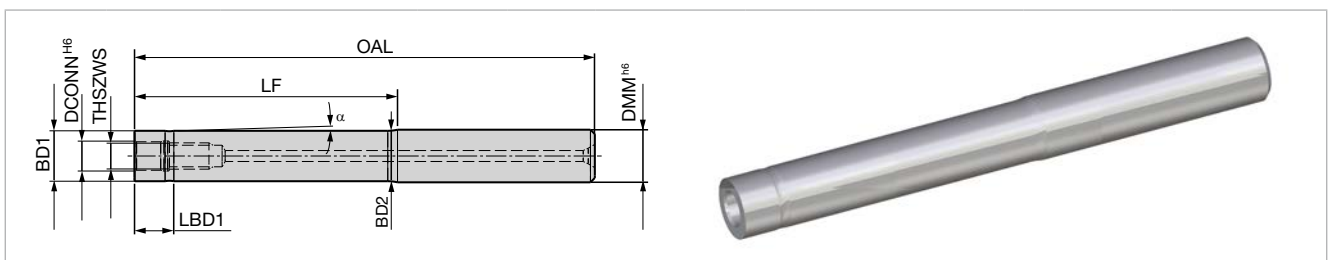

THSZWS	DCONN ^{H6}	BD1	d ₂	DMM ^{H6}	α	LF	OAL	LBD1	Bestellbezeichnung Ordering code	Material-Nr. Material-No.	Verfügbarkeit Availability
12	12,5	23	24,3	25	0,591°	80	136	9	K 25.080 M12	5088769	●
12	12,5	23	24,3	25	0,449°	100	156	9	K 25.100 M12	5088776	●
12	12,5	23	24,3	25	0,362°	120	176	9	K 25.120 M12	5088777	●
12	12,5	23	24,3	25	0,303°	140	196	9	K 25.140 M12	5088779	●
12	12,5	23	24,3	25	0,260°	160	216	9	K 25.160 M12	5088781	●

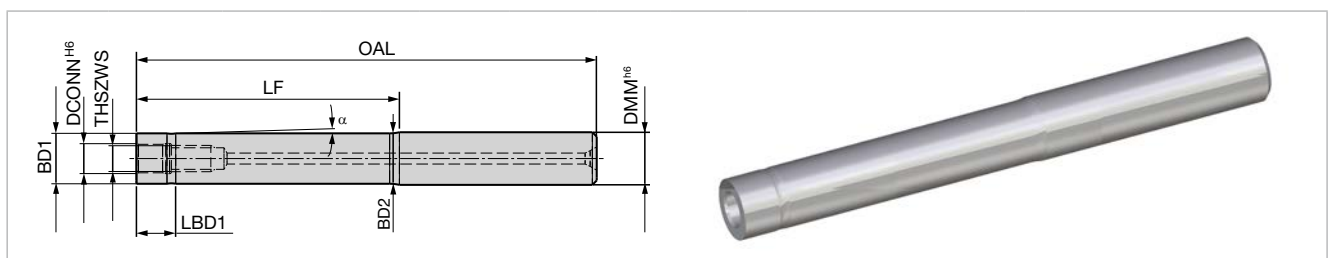

THSZWS	DCONN ^{H6}	BD1	d ₂	DMM ^{H6}	α	LF	OAL	LBD1	Bestellbezeichnung Ordering code	Material-Nr. Material-No.	Verfügbarkeit Availability
16	17	29	31,5	32	0,828°	100	160	9	K 32.100 M16	5088789	●
16	17	29	31,5	32	0,517°	150	210	9	K 32.150 M16	5088788	●
16	17	29	31,5	32	0,376°	200	260	9	K 32.200 M16	5088787	●
16	17	29	31,5	32	0,295°	250	310	9	K 32.250 M16	5088786	●
16	17	29	31,5	32	0,243°	300	360	9	K 32.300 M16	5088784	●

Bestellbeispiel Order example: 1 Stück piece 5088552 oder or K 20.040 M10

Vollhartmetall-Verlängerungen für Einschraubwerkzeug INCH
Solid carbide extensions for screw on type milling cutter INCH

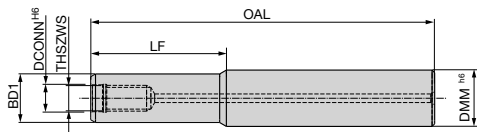

Abmessungen [INCH] Dimensions [INCH]						Material-Nr. Material-No.	Bestellbezeichnung Ordering code	Verfügbarkeit Availability
THSZWS	DCONN ^{H6}	BD1	DMM ^{H6}	LF	OAL			
6	0.256	0.374	0.375	1.496	4.330	5153910	ZU 03750.1500 M06	○
6	0.256	0.374	0.375	2.086	5.512	5153911	ZU 03750.2000 M06	○
6	0.256	0.433	0.500	1.457	4.803	5153912	ZU 05000.1500 M06	○
6	0.256	0.433	0.500	2.047	6.378	5153914	ZU 05000.2000 M06	○

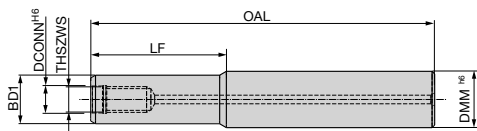

Abmessungen [INCH] Dimensions [INCH]						Material-Nr. Material-No.	Bestellbezeichnung Ordering code	Verfügbarkeit Availability
THSZWS	DCONN ^{H6}	BD1	DMM ^{H6}	LF	OAL			
8	0.335	0.543	0.625	1.654	5.591	5153917	ZU 06250.1600 M08	○
8	0.335	0.543	0.625	1.654	6.968	5153918	ZU 06250.2200 M08	○

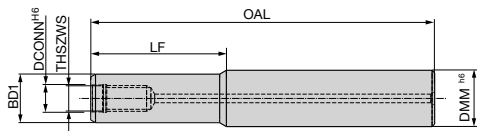

Abmessungen [INCH] Dimensions [INCH]						Material-Nr. Material-No.	Bestellbezeichnung Ordering code	Verfügbarkeit Availability
THSZWS	DCONN ^{H6}	BD1	DMM ^{H6}	LF	OAL			
10	0.413	0.7908	0.750	2.126	5.669	5153919	ZU 07500.2100 M10	○
10	0.413	0.7908	0.750	3.071	7.637	5153947	ZU 07500.3000 M10	○

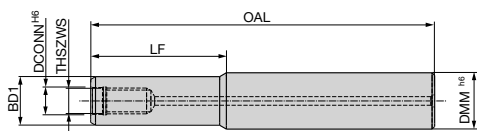

Abmessungen [INCH] Dimensions [INCH]						Material-Nr. Material-No.	Bestellbezeichnung Ordering code	Verfügbarkeit Availability
THSZWS	DCONN ^{H6}	BD1	DMM ^{H6}	LF	OAL			
12	0.492	0.890	1.000	2.362	6.299	5153951	ZU 10000.2300 M12	○
12	0.492	0.890	1.000	3.543	8.267	5153966	ZU 10000.3500 M12	○

Bestellbeispiel Order example: 1 Stück piece 5153910 oder or ZU 03750.1500 M06

- Verfügbar ab Lager Available from stock
- Lieferzeit auf Anfrage Delivery time on request

Vollhartmetall-Verlängerungen für Einschraubwerkzeug INCH
Solid carbide extensions for screw on type milling cutter INCH

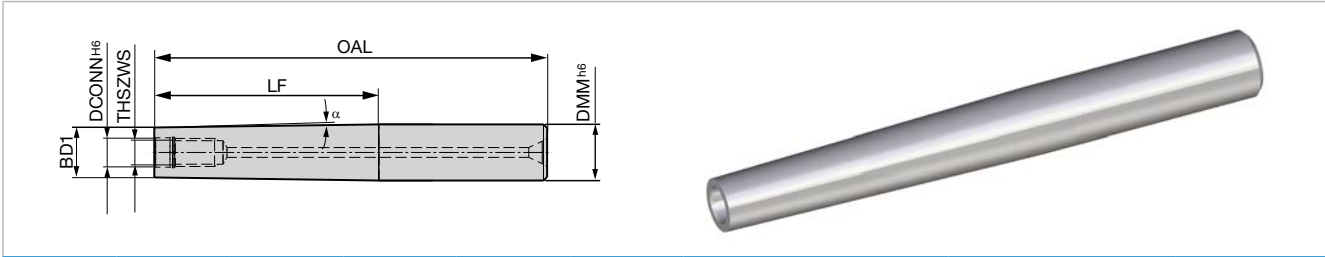

Abmessungen [INCH] Dimensions [INCH]							Material-Nr. Material-No.	Bestellbezeichnung Ordering code	Verfügbarkeit Availability
THSZWS	DCONN ^{H6}	BD1	DMM ^{h6}	α	LF	OAL			
6	0.256	0.374	0.500	1.0°	3.031	4.921	5153967	KU 05000.3000 M06	○
6	0.256	0.374	0.500	0.4°	5.000	6.889	5153969	KU 05000.5000 M06	○

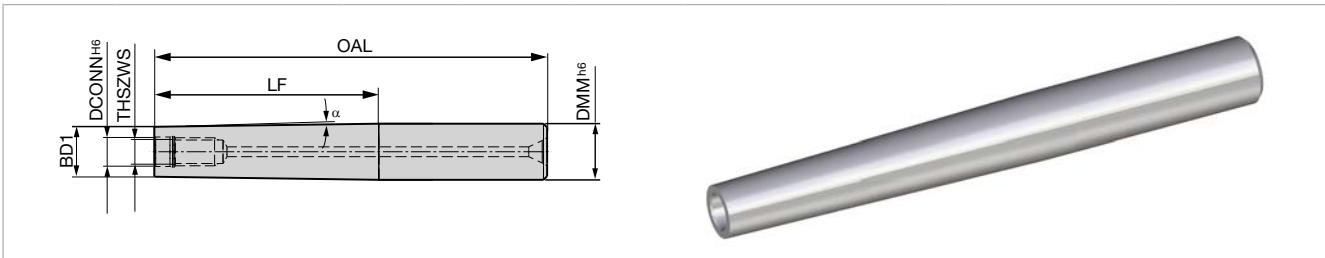

Abmessungen [INCH] Dimensions [INCH]							Material-Nr. Material-No.	Bestellbezeichnung Ordering code	Verfügbarkeit Availability
THSZWS	DCONN ^{H6}	BD1	DMM ^{h6}	α	LF	OAL			
8	0.334	0.492	0.625	0.8°	3.937	5.905	5153970	KU 06250.4000 M08	○
8	0.334	0.492	0.625	0.6°	4.921	6.889	5153971	KU 06250.5000 M08	○

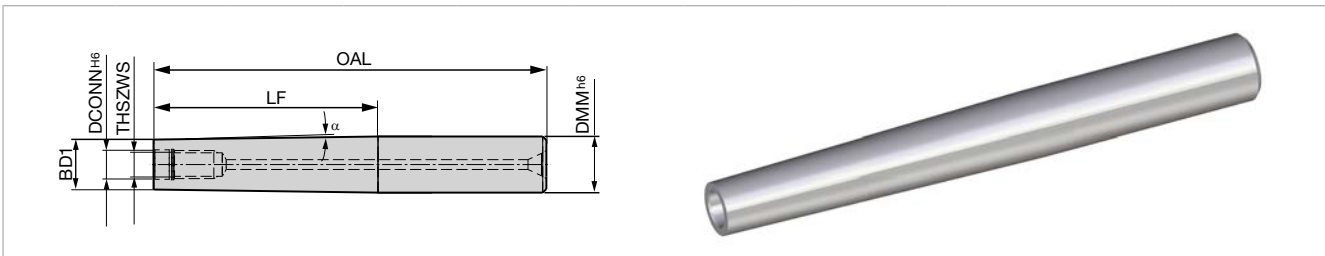

Abmessungen [INCH] Dimensions [INCH]							Material-Nr. Material-No.	Bestellbezeichnung Ordering code	Verfügbarkeit Availability
THSZWS	DCONN ^{H6}	BD1	DMM ^{h6}	α	LF	OAL			
10	0.413	0.669	0.750	0.35°	3.700	5.905	5153976	KU 07500.3700 M10	○
10	0.413	0.669	0.750	0.35°	5.669	7.874	5153978	KU 07500.5600 M10	○

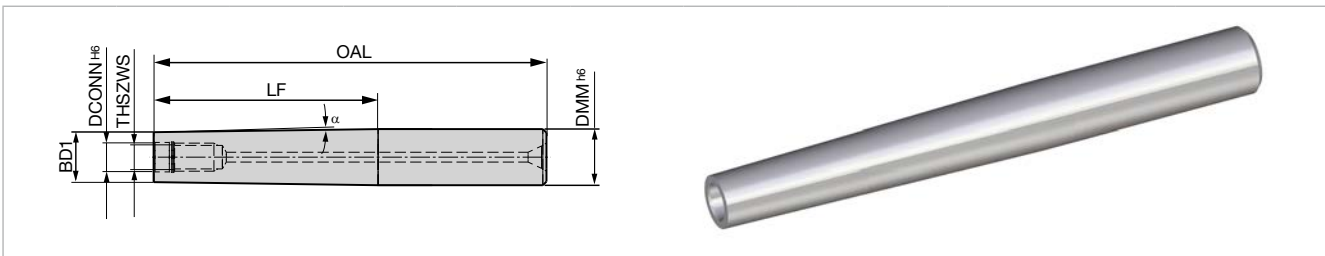

Abmessungen [INCH] Dimensions [INCH]							Material-Nr. Material-No.	Bestellbezeichnung Ordering code	Verfügbarkeit Availability
THSZWS	DCONN ^{H6}	BD1	DMM ^{h6}	α	LF	OAL			
12	0.492	0.787	1.000	1.2°	4.094	6.299	5153979	KU 10000.4000 M12	○
12	0.492	0.787	1.000	1.0°	6.063	8.267	5153980	KU 10000.6000 M12	○

Bestellbeispiel Order example: 1 Stück piece 5153967 oder or KU 05000.3000 M06

- Verfügbar ab Lager Available from stock
- Lieferzeit auf Anfrage Delivery time on request

SK - Aufnahmen Chucks

Fräseraufnahme (Weldon) - für Zylinderschäfte (BE Typen) gemäß DIN 1835B

End mill holder (Weldon) - for cylindrical shanks (BE Typs) according to DIN 1835B

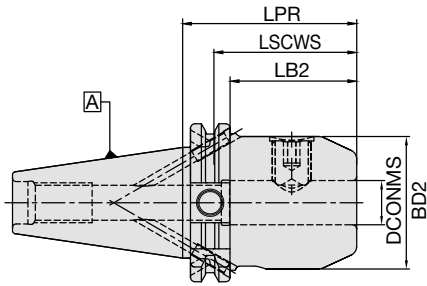

SK 40										Verfügbarkeit Availability
d (mm)	D (mm)	A (mm)	L1 (mm)	L3 (mm)	g	Kühlmitteleinzufuhr Coolant supply	N/W (Kg)	Bezeichnung Designation	Ident No.	
16	48	35	49	15.9	M14	Form "AD"	1.0	WSLH/16-35/SK40*	4600771	●
20	50	35	51	15.9	M16	Form "AD"	1.0	WSLH/20-35/SK40*	4600782	●
25	50	35	59	15.9	M16	Form "AD"	1.0	WSLH/25-35/SK40*	4600788	●
32	50	65	63	45.9	M16	Form "AD"	1.2	WSLH/32-65/SK40*	4600792	●
06	25	50	37	30.9	M6	Form "AD/B"	1.0	WSLH/06-50/SK40	4600745	○
08	28	50	37	30.9	M8	Form "AD/B"	1.0	WSLH/08-50/SK40	4600750	○
10	35	50	41	30.9	M10	Form "AD/B"	1.1	WSLH/10-50/SK40	4600755	○
12	42	50	46	30.9	M12	Form "AD/B"	1.2	WSLH/12-50/SK40	4600760	○
14	44	50	46	30.9	M12	Form "AD/B"	1.2	WSLH/14-50/SK40	4600765	○
16	48	63	49	43.9	M14	Form "AD/B"	1.2	WSLH/16-63/SK40	4600770	○
18	50	63	49	43.9	M14	Form "AD/B"	1.4	WSLH/18-63/SK40	4600776	○
20	50	63	51	43.9	M16	Form "AD/B"	1.5	WSLH/20-63/SK40	4600781	○
06	25	100	37	80.9	M6	Form "AD/B"	1.2	WSLH/06-100/SK40	4600746	○
08	28	100	37	80.9	M8	Form "AD/B"	1.2	WSLH/08-100/SK40	4600751	○
10	35	100	41	80.9	M10	Form "AD/B"	1.4	WSLH/10-100/SK40	4600756	○
12	42	100	46	80.9	M12	Form "AD/B"	1.6	WSLH/12-100/SK40	4600761	○
14	44	100	46	80.9	M12	Form "AD/B"	1.7	WSLH/14-100/SK40	4600766	○
16	48	100	49	80.9	M14	Form "AD/B"	1.7	WSLH/16-100/SK40	4600772	○
18	50	100	49	80.9	M14	Form "AD/B"	2.0	WSLH/18-100/SK40	4600777	○
20	52	100	51	80.9	M16	Form "AD/B"	2.0	WSLH/20-100/SK40	4600783	○
25	65	100	59	80.9	M18	Form "AD/B"	2.7	WSLH/25-100/SK40 **	4600787	○
32	72	100	63	80.9	M20	Form "AD/B"	2.5	WSLH/32-100/SK40 **	4600791	○
40	80	120	73	100.9	M20	Form "AD/B"	3.0	WSLH/40-120/SK40 **	4600795	○
06	25	160	37	140.9	M6	Form "AD/B"	1.5	WSLH/06-160/SK40	4600748	○
08	28	160	37	140.9	M8	Form "AD/B"	1.5	WSLH/08-160/SK40	4600753	○
10	35	160	41	140.9	M10	Form "AD/B"	1.7	WSLH/10-160/SK40	4600758	○
12	42	160	46	140.9	M12	Form "AD/B"	2.2	WSLH/12-160/SK40	4600763	○
14	44	160	46	140.9	M12	Form "AD/B"	2.3	WSLH/14-160/SK40	4600768	○
16	48	160	49	140.9	M14	Form "AD/B"	1.7	WSLH/16-160/SK40	4600774	○
18	50	160	49	140.9	M14	Form "AD/B"	2.6	WSLH/18-160/SK40	4600779	○
20	52	160	51	140.9	M16	Form "AD/B"	2.8	WSLH/20-160/SK40	4600785	○
25	65	160	59	140.9	M18	Form "AD/B"	3.8	WSLH/25-160/SK40 **	4600789	○
32	72	160	63	140.9	M20	Form "AD/B"	4.4	WSLH/32-160/SK40 **	4600793	○

Ersatzteile und Zubehör / Spare Parts & Accessories: Pg.D6

Pg.E2

- Datenträger-Bohrung (10mm) Standard bei allen Grundhaltern
- Bohrungstoleranz H4
- * Extra kurze Aufnahmen:
 - Die Spannschrauben sind im Mitnehmer
 - Maximale Steifigkeit dank kurzer Ausraglänge
- Im Lieferumfang enthalten: Spannschraube
- Höhere Wuchtgüte auf Anfrage
- ** 2 Spannschrauben für ID Größe = 25 / 32 / 40

- Data carrier bore (10mm) as standard for all holders
- Bore tolerance H4
- * Extra short holders:
 - Locking screws are located in the same plane as drive slots
 - Gives maximum rigidity due to short projection
- Delivery includes: Locking screw
- Higher balancing grade on request
- ** 2 locking screws for ID size = 25 / 32 / 40

Das gesamte Aufnahmen Sortiment mit Ersatzteilen entnehmen Sie dem Bilz-Katalog
 CNC Grip / Thermo Grip www.bilz.de
 The complete chuck range also the spare parts refer to the Bilz- catalog
 CNC Grip / Thermo Grip www.bilz.de

- Verfügbar ab Lager Available from stock
- kurzfristig lieferbar available at short notice

SK - Aufnahmen Chucks

Aufnahmen für Einschraubfräser (BS Typen)

Chuck for screw on type (BS Typs)

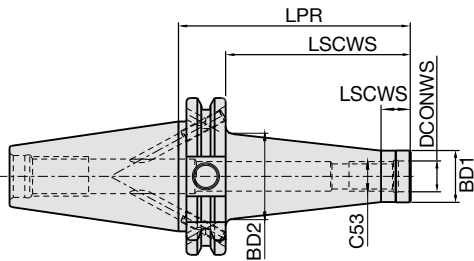

SK 40										Verfügbarkeit Availability
G	d (mm)	D1 (mm)	D2 (mm)	A (mm)	L1 (mm)	L3 (mm)	Kühlmittelezufuhr Coolant supply	Bezeichnung Designation	Ident No.	
M6	6.5	10.0	13	44	12	24.9	Form "AD/B"	WTA/M6-44/SK40	5054973	●
M6	6.5	10.0	20	69	12	49.9	Form "AD/B"	WTA/M6-69/SK40	5054974	●
M6	6.5	10.0	23	94	12	74.9	Form "AD/B"	WTA/M6-94/SK40	5054975	●
M8	8.5	13.8	15	44	12	24.9	Form "AD/B"	WTA/M8-44/SK40	5054979	●
M8	8.5	13.8	23	69	12	49.9	Form "AD/B"	WTA/M8-69/SK40	5054980	●
M8	8.5	13.8	25	94	12	74.9	Form "AD/B"	WTA/M8-94/SK40	5054981	●
M8	8.5	13.8	30	119	12	99.9	Form "AD/B"	WTA/M8-119/SK40	5054982	●
M10	10.5	18.0	23	44	12	24.9	Form "AD/B"	WTA/M10-44/SK40	5054983	●
M10	10.5	18.0	25	69	12	49.9	Form "AD/B"	WTA/M10-69/SK40	5054985	●
M10	10.5	18.0	30	94	12	74.9	Form "AD/B"	WTA/M10-94/SK40	5054989	●
M10	10.5	18.0	35	119	12	99.9	Form "AD/B"	WTA/M10-119/SK40	5054991	●
M10	10.5	18.0	45	169	12	149.9	Form "AD/B"	WTA/M10-169/SK40	5054992	●
M12	12.5	21.0	24	44	12	24.9	Form "AD/B"	WTA/M12-44/SK40	5054993	●
M12	12.5	21.0	30	69	12	49.9	Form "AD/B"	WTA/M12-69/SK40	5054995	●
M12	12.5	21.0	35	94	12	74.9	Form "AD/B"	WTA/M12-94/SK40	5054996	●
M12	12.5	21.0	38	119	12	99.9	Form "AD/B"	WTA/M12-119/SK40	5054997	●
M12	12.5	21.0	48	169	12	149.9	Form "AD/B"	WTA/M12-169/SK40	5054998	●
M16	17.0	29.0	29	44	12	24.9	Form "AD/B"	WTA/M16-44/SK40	5054999	●
M16	17.0	29.0	34	69	12	49.9	Form "AD/B"	WTA/M16-69/SK40	5055001	●
M16	17.0	29.0	35	94	12	74.9	Form "AD/B"	WTA/M16-94/SK40	5055002	●
M16	17.0	29.0	40	119	12	99.9	Form "AD/B"	WTA/M16-119/SK40	5055003	●
M16	17.0	29.0	48	169	12	149.9	Form "AD/B"	WTA/M16-169/SK40	5054004	●

SK 50										Verfügbarkeit Availability
G	d (mm)	D1 (mm)	D2 (mm)	A (mm)	L1 (mm)	L3 (mm)	Kühlmittelezufuhr Coolant supply	Bezeichnung Designation	Ident No.	
M8	8.5	13.8	23	69	12	49.9	Form "AD/B"	WTA/M8-69/SK50	5055005	●
M8	8.5	13.8	30	119	12	99.9	Form "AD/B"	WTA/M8-119/SK50	5055007	●
M8	8.5	13.8	45	169	12	149.9	Form "AD/B"	WTA/M8-169/SK50	5055011	●
M10	10.5	18.0	25	69	12	49.9	Form "AD/B"	WTA/M10-69/SK50	5055012	●
M10	10.5	18.0	35	119	12	99.9	Form "AD/B"	WTA/M10-119/SK50	5055013	●
M10	10.5	18.0	45	169	12	149.9	Form "AD/B"	WTA/M10-169/SK50	5055014	●
M12	12.5	21.0	30	69	12	49.9	Form "AD/B"	WTA/M12-69/SK50	5055016	●
M12	12.5	21.0	38	119	12	99.9	Form "AD/B"	WTA/M12-119/SK50	5055017	●
M12	12.5	21.0	52	169	12	149.9	Form "AD/B"	WTA/M12-169/SK50	5055018	●
M16	17.0	29.0	34	69	12	49.9	Form "AD/B"	WTA/M16-69/SK50	5055019	●
M16	17.0	29.0	40	119	12	99.9	Form "AD/B"	WTA/M16-119/SK50	5055022	●
M16	17.0	29.0	48	169	12	149.9	Form "AD/B"	WTA/M16-169/SK50	5055023	●

Ersatzteile und Zubehör / Spare Parts & Accessories: Pg.D6

Siehe Seite D12 für Einschraubfräser Verlängerung & Reduzierung
Refer page. D12 for Threaded Arbor extensions & reductions.

Das gesamte Aufnahmen Sortiment mit Ersatzteilen entnehmen Sie dem Bilz-Katalog
CNC Grip / Thermo Grip www.bilz.de
The complete chuck range also the spare parts refer to the Bilz- catalog
CNC Grip / Thermo Grip www.bilz.de

● Verfügbar ab Lager Available from stock
○ kurzfristig lieferbar available at short notice

SK - Aufnahmen Chucks

Aufnahmedorn mit Innenzentrierung DIN 6357 mit vergrößertem Bunddurchmesser für Aufsteckfräser (BF Typen)

Shell mill holder DIN 6357for cutters with drive key face mill type cutter (BF Typs)

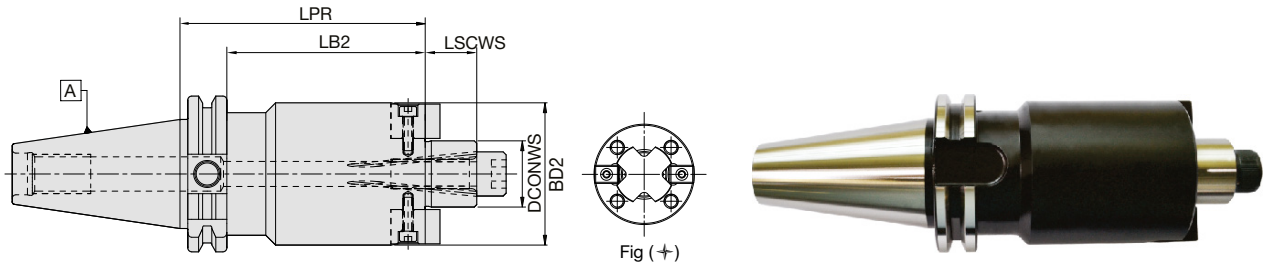

SK 40												Verfügbarkeit Availability
d (mm)	D (mm)	A (mm)	L1 (mm)	L3 (mm)	Kühlmittelezufuhr Coolant supply	N/W (Kg)	Bezeichnung Designation	Ident No.				
16	38	35	17	15.9	Form "AD/B"	1.0	WSMH/16-35/SK40	4600822	●			
22	48	35	19	15.9	Form "AD/B"	1.0	WSMH/22-35/SK40	4600823	●			
27	50	40	21	20.9	Form "AD/B"	1.1	WSMH/27-40/SK40	4600824	●			
32	78	50	24	30.9	Form "AD/B"	1.3	WSMH/32-50/SK40	4600825	●			
40	88	50	27	30.9	Form "AD/B"	1.6	WSMH/40-50/SK40+*	4600826	●			
16	38	100	17	80.9	Form "AD/B"	1.8	WSMH/16-100/SK40	5055095	○			
22	48	100	19	80.9	Form "AD/B"	2.1	WSMH/22-100/SK40	5055102	○			
27	58	100	21	80.9	Form "AD/B"	2.6	WSMH/27-100/SK40	5055104	○			
32	78	100	24	80.9	Form "AD/B"	3.6	WSMH/32-100/SK40	5055105	○			
40	88	100	27	80.9	Form "AD/B"	4.3	WSMH/40-100/SK40+*	5055106	○			
16	38	160	17	140.9	Form "AD/B"	2.1	WSMH/16-160/SK40	5055107	○			
22	48	160	19	140.9	Form "AD/B"	2.7	WSMH/22-160/SK40	5055108	○			
27	58	160	21	140.9	Form "AD/B"	3.7	WSMH/27-160/SK40	5055109	○			
32	78	160	24	140.9	Form "AD/B"	5.8	WSMH/32-160/SK40	5055110	○			
40	88	160	27	140.9	Form "AD/B"	6.6	WSMH/40-160/SK40+*	5055111	○			

SK 50												Verfügbarkeit Availability
d (mm)	D (mm)	A (mm)	L1 (mm)	L3 (mm)	Kühlmittelezufuhr Coolant supply	N/W (Kg)	Bezeichnung Designation	Ident No.				
16	38	44	17	24.9	Form "AD/B"	2.8	WSMH/16-44/SK50	5055112	○			
22	48	44	19	24.9	Form "AD/B"	3.0	WSMH/22-44/SK50	4601356	○			
27	58	44	21	24.9	Form "AD/B"	3.2	WSMH/27-44/SK50	4601357	○			
32	78	40	24	20.9	Form "AD/B"	4.0	WSMH/32-40/SK50	4601358	○			
40	88	50	27	30.9	Form "AD/B"	4.2	WSMH/40-50/SK50+*	4601359	○			
60	129	70	40	50.9	-	4.8	WSMH/60-70/SK50+	4601360	○			
16	38	100	17	80.9	Form "AD/B"	3.6	WSMH/16-100/SK50	5055123	○			
22	48	100	19	80.9	Form "AD/B"	4.0	WSMH/22-100/SK50	5055125	○			
27	58	100	21	80.9	Form "AD/B"	4.4	WSMH/27-100/SK50	5055126	○			
32	78	100	24	80.9	Form "AD/B"	5.2	WSMH/32-100/SK50	5055127	○			
40	88	100	27	80.9	Form "AD/B"	6.0	WSMH/40-100/SK50+*	5055128	○			
16	38	160	17	140.9	Form "AD/B"	3.9	WSMH/16-160/SK50	5055130	○			
22	48	160	19	140.9	Form "AD/B"	4.2	WSMH/22-160/SK50	5055131	○			
27	58	160	21	140.9	Form "AD/B"	5.3	WSMH/27-160/SK50	5055132	○			
32	78	160	24	140.9	Form "AD/B"	7.2	WSMH/32-160/SK50	5055133	○			
40	88	160	27	140.9	Form "AD/B"	8.8	WSMH/40-160/SK50+*	5055134	○			

Ersatzteile und Zubehör / Spare Parts & Accessories: Pg.D8 Pg.E3 Pg.E4 Pg.D6 Pg.E4

- Datenträger-Bohrung (10 mm) Standard bei allen Grundhaltern
 - Kühlbohrung an der Stirnseite Standard bei allen Grundhaltern
 - + ID = Ø 40, D = Ø 60 Mit 4 zusätzlichen Gewindebohrungen nach DIN 2079
 - Im Lieferumfang enthalten: Mitnehmersteine, Fräseranzugsschraube und Spannschrauben (DIN 912)
 - Spannschrauben bitte separat bestellen (DIN6367)
 - * Im Lieferumfang enthalten: Spannschrauben (DIN 912 & DIN 6367)
- Data carrier bore (10 mm) as standard for all holders
 - Coolant bore on the pilot face (holder with Form "AD/B") as standard for all holders
 - + ID = Ø 40, d = Ø 60 with additional 4 screw holes to DIN 2079
 - Delivery includes: Drive keys, clamping screw and locking screw(DIN 912)
 - Please order locking screw (DIN 6367) separately
 - * Delivery includes: Locking screw (both DIN 912 & DIN 6367)

Das gesamte Aufnahmen Sortiment mit Ersatzteilen entnehmen Sie dem Bilz-Katalog
 CNC Grip / Thermo Grip www.bilz.de
 The complete chuck range also the spare parts refer to the Bilz- catalog
 CNC Grip / Thermo Grip www.bilz.de

- Verfügbar ab Lager Available from stock
- kurzfristig lieferbar available at short notice

HSK - Aufnahmen Chucks

Fräseraufnahmen (Weldon) - für Zylinderschäfte gemäß DIN 1835B (BE Typen)

End mill holder (Weldon) - for cylindrical shanks according to DIN 1835B (BE Typs)

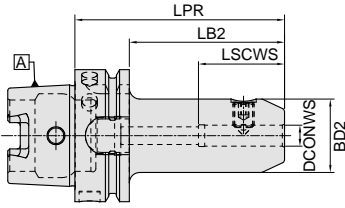

HSK-A63										≤ 3µm	G2.5 15000 RPM	bar	Verfügbar- keit Availability
d (mm)	D (mm)	A (mm)	L1 (mm)	L3 (mm)	g	Kühlmittelzufuhr Coolant supply	N/W (Kg)	Bezeichnung Designation	Ident No.				
06	25	65	37	39	M6	Form "AD"	1.0	WSLH/06-65/HSK-A63	4601702	○			
08	28	65	37	39	M8	Form "AD"	1.0	WSLH/08-65/HSK-A63	4601705	○			
10	35	65	41	39	M10	Form "AD"	1.0	WSLH/10-65/HSK-A63	4601708	○			
12	42	80	46	54	M12	Form "AD"	1.4	WSLH/12-80/HSK-A63	4601711	○			
14	44	80	46	54	M12	Form "AD"	1.4	WSLH/14-80/HSK-A63	4601715	○			
16	48	80	49	54	M14	Form "AD"	1.4	WSLH/16-80/HSK-A63	4601719	○			
18	50	80	49	54	M14	Form "AD"	1.7	WSLH/18-80/HSK-A63	4601723	○			
20	52	80	51	54	M16	Form "AD"	1.7	WSLH/20-80/HSK-A63	4601727	●			
06	25	100	37	74	M6	Form "AD"	1.2	WSLH/06-100/HSK-A63	4601703	○			
08	28	100	37	74	M8	Form "AD"	1.2	WSLH/08-100/HSK-A63	4601706	○			
10	35	100	41	74	M10	Form "AD"	1.2	WSLH/10-100/HSK-A63	4601709	○			
12	42	100	46	74	M12	Form "AD"	1.5	WSLH/12-100/HSK-A63	5056629	○			
16	48	100	49	74	M14	Form "AD"	1.7	WSLH/16-100/HSK-A63	5056632	○			
20	52	100	51	74	M16	Form "AD"	1.9	WSLH/20-100/HSK-A63	5056495	○			
25	62.5	110	59	84	M18 x2	Form "AD"	2.5	WSLH/25-110/HSK-A63 **	4601730	●			
32	72	110	63	84	M20 x2	Form "AD"	2.5	WSLH/32-110/HSK-A63 **	4601732	●			
40	80	125	73	99	M20 x2	Form "AD"	3.2	WSLH/40-125/HSK-A63 **	4601734	○			

HSK-A63										≤ 3µm	G6.3 15000 RPM	bar	Verfügbar- keit Availability
d (mm)	D (mm)	A (mm)	L1 (mm)	L3 (mm)	g	Kühlmittelzufuhr Coolant supply	N/W (Kg)	Bezeichnung Designation	Ident No.				
06	25	160	37	134	M6	Form "AD"	1.4	WSLH/06-160/HSK-A63	5056636	○			
08	28	160	37	134	M8	Form "AD"	1.5	WSLH/08-160/HSK-A63	5056638	○			
10	35	160	41	134	M10	Form "AD"	1.8	WSLH/10-160/HSK-A63	5056640	○			
12	42	160	46	134	M12	Form "AD"	1.8	WSLH/12-160/HSK-A63	5056642	○			
16	48	160	49	134	M14	Form "AD"	1.8	WSLH/16-160/HSK-A63	5056643	○			
20	52	160	51	134	M16	Form "AD"	1.7	WSLH/20-160/HSK-A63	5056645	○			

HSK-A100										≤ 3µm	G6.3 15000 RPM	bar	Verfügbar- keit Availability
d (mm)	D (mm)	A (mm)	L1 (mm)	L3 (mm)	g	Kühlmittelzufuhr Coolant supply	N/W (Kg)	Bezeichnung Designation	Ident No.				
06	25	80	37	51	M6	Form "AD"	2.5	WSLH/06-80/HSK-A100	4601614	○			
08	28	80	37	51	M8	Form "AD"	2.4	WSLH/08-80/HSK-A100	4601616	○			
10	35	80	41	51	M10	Form "AD"	2.5	WSLH/10-80/HSK-A100	4601618	○			
12	42	80	46	51	M12	Form "AD"	2.7	WSLH/12-80/HSK-A100	4601620	○			
14	44	80	46	51	M12	Form "AD"	2.7	WSLH/14-80/HSK-A100	4601622	○			
16	48	100	49	71	M14	Form "AD"	2.8	WSLH/16-100/HSK-A100	4601624	●			
18	50	100	49	71	M14	Form "AD"	2.9	WSLH/18-100/HSK-A100	4601626	○			
20	52	100	51	71	M16	Form "AD"	3.2	WSLH/20-100/HSK-A100	4601628	●			
25	65	100	59	71	M18 x2	Form "AD"	3.7	WSLH/25-100/HSK-A100 **	4601630	●			
32	72	100	63	71	M20 x2	Form "AD"	4.0	WSLH/32-100/HSK-A100 **	4601632	●			
40	80	105	73	76	M20 x2	Form "AD"	4.7	WSLH/40-105/HSK-A100 **	4601634	○			

HSK-A100										≤ 3µm	G6.3 15000 RPM	bar	Verfügbar- keit Availability
d (mm)	D (mm)	A (mm)	L1 (mm)	L3 (mm)	g	Kühlmittelzufuhr Coolant supply	N/W (Kg)	Bezeichnung Designation	Ident No.				
06	25	160	37	131	M6	Form "AD"	2.7	WSLH/06-160/HSK-A100	5056735	○			
08	28	160	37	131	M8	Form "AD"	2.9	WSLH/08-160/HSK-A100	5056736	○			
10	35	160	41	131	M10	Form "AD"	3.1	WSLH/10-160/HSK-A100	5056737	○			
12	42	160	46	131	M12	Form "AD"	3.6	WSLH/12-160/HSK-A100	5056739	○			
16	48	160	49	131	M14	Form "AD"	3.9	WSLH/16-160/HSK-A100	5056740	○			
20	52	160	51	131	M16	Form "AD"	4.4	WSLH/20-160/HSK-A100	5056742	○			
25	65	160	59	131	M18 x2	Form "AD"	5.3	WSLH/25-160/HSK-A100 **	5056743	○			

Ersatzteile und Zubehör / Spare Parts & Accessories: Pg.E2 Pg.D8

- Bohrungstoleranz H4
- Kühlmittelrohr bitte separat bestellen (Siehe Seite D8)
- Im Lieferumfang enthalten: Spannschraube
- ** 2 Spannschrauben für ID Größe = 25 / 32 / 40
- Bore tolerance H4
- Please order coolant tube separately (See page D8)
- Delivery includes: Locking screw
- ** 2 locking screws for ID size = 25 / 32 / 40

Das gesamte Aufnahmen Sortiment mit Ersatzteilen entnehmen Sie dem Bilz-Katalog

CNC Grip / Thermo Grip www.bilz.de

The complete chuck range also the spare parts refer to the Bilz- catalog

CNC Grip / Thermo Grip www.bilz.de

- Verfügbar ab Lager Available from stock
- kurzfristig lieferbar available at short notice

HSK - Aufnahmen Chucks

Aufnahmen für Einschraubfräser (BS Typen)

Chuck for screw on type milling heads (BS Typs)

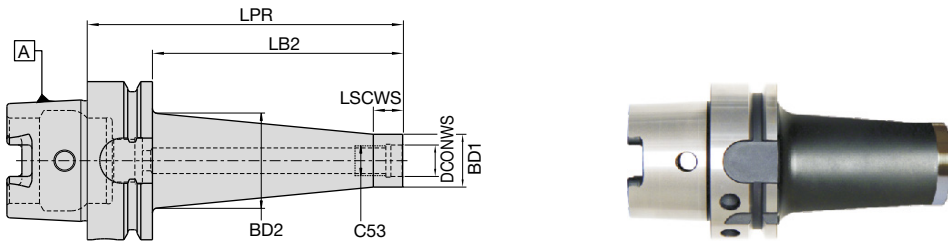

HSK-A63										Verfügbarkeit Availability
G	d (mm)	D1 (mm)	D2 (mm)	A (mm)	L1 (mm)	L3 (mm)	Kühlmittelezufuhr Coolant supply	Bezeichnung Designation	Ident No.	
M8	8.5	13.8	15	51	12	25	Form "AD"	WTA/M8-51/HSK-A63	5055783	●
M8	8.5	13.8	23	76	12	50	Form "AD"	WTA/M8-76/HSK-A63	5055784	○
M8	8.5	13.8	25	101	12	75	Form "AD"	WTA/M8-101/HSK-A63	5055785	○
M10	10.5	18.0	23	51	12	25	Form "AD"	WTA/M10-51/HSK-A63	5055786	●
M10	10.5	18.0	25	76	12	50	Form "AD"	WTA/M10-76/HSK-A63	5055787	○
M10	10.5	18.0	35	126	12	100	Form "AD"	WTA/M10-126/HSK-A63	5055788	○
M10	10.5	18.0	45	176	12	150	Form "AD"	WTA/M10-176/HSK-A63	5055789	○
M12	12.5	21.0	24	51	12	25	Form "AD"	WTA/M12-51/HSK-A63	5055790	●
M12	12.5	21.0	30	76	12	50	Form "AD"	WTA/M12-76/HSK-A63	5055791	○
M12	12.5	21.0	38	126	12	100	Form "AD"	WTA/M12-126/HSK-A63	5055792	○
M12	12.5	21.0	45	176	12	150	Form "AD"	WTA/M12-176/HSK-A63	5055793	○
M16	17.0	29.0	29	51	12	25	Form "AD"	WTA/M16-51/HSK-A63	5055794	●
M16	17.0	29.0	34	76	12	50	Form "AD"	WTA/M16-76/HSK-A63	5055795	○
M16	17.0	29.0	40	126	12	100	Form "AD"	WTA/M16-126/HSK-A63	5055796	○
M16	17.0	29.0	48	176	12	150	Form "AD"	WTA/M16-176/HSK-A63	5055797	○

HSK-A100										Verfügbarkeit Availability
G	d (mm)	D1 (mm)	D2 (mm)	A (mm)	L1 (mm)	L3 (mm)	Kühlmittelezufuhr Coolant supply	Bezeichnung Designation	Ident No.	
M10	10.5	18.0	25	79	12	50	Form "AD"	WTA/M10-79/HSK-A100	5055798	●
M10	10.5	18.0	35	129	12	100	Form "AD"	WTA/M10-129/HSK-A100	5055799	○
M10	10.5	18.0	45	179	12	150	Form "AD"	WTA/M10-179/HSK-A100	5055800	○
M12	12.5	21.0	30	79	12	50	Form "AD"	WTA/M12-79/HSK-A100	5055801	●
M12	12.5	21.0	38	129	12	100	Form "AD"	WTA/M12-129/HSK-A100	5055802	○
M12	12.5	21.0	45	179	12	150	Form "AD"	WTA/M12-179/HSK-A100	5055803	○
M16	17.0	29.0	34	79	12	50	Form "AD"	WTA/M16-79/HSK-A100	5055804	●
M16	17.0	29.0	40	129	12	100	Form "AD"	WTA/M16-129/HSK-A100	5055805	○
M16	17.0	29.0	48	179	12	150	Form "AD"	WTA/M16-179/HSK-A100	5055806	○

Ersatzteile und Zubehör / Spare Parts & Accessories: Pg.D8

- Kühlmittelrohr bitte separat bestellen (Siehe Seite D8)
- Siehe Seite D12 für Einschraubfräser Verlängerung & Reduzierung
- Please order coolant tube separately (See page D8)
- Refer page D12 for Threaded Arbor extensions & reductions.

Das gesamte Aufnahmen Sortiment mit Ersatzteilen entnehmen Sie dem Bilz-Katalog

CNC Grip / Thermo Grip www.bilz.de

The complete chuck range also the spare parts refer to the Bilz- catalog

CNC Grip / Thermo Grip www.bilz.de

- Verfügbar ab Lager Available from stock
- kurzfristig lieferbar available at short notice

HSK - Aufnahmen Chucks

Aufnahmedorn mit Innenzentrierung DIN 6357 und vergrößertem Bunddurchmesser (BF Typen)

Shell mill holder DIN 6357 for cutters with drive key (BF Typs)

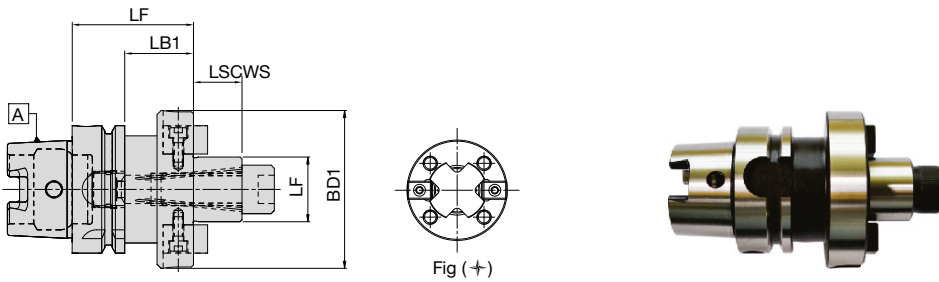

Fig (+)

HSK-A50										Verfügbarkeit Availability
d (mm)	D (mm)	A (mm)	L1 (mm)	L3 (mm)	Kühlmittelezufuhr Coolant supply	N/W (kg)	Bezeichnung Designation	Ident No.		
16	38	50	17	24	Form "AD"	0.8	WSMH/16-50/HSK-A50	5103448	●	
22	48	60	19	34	Form "AD"	1.0	WSMH/22-60/HSK-A50	5103450	●	
27	58	60	21	34	Form "AD"	1.1	WSMH/27-60/HSK-A50	5103452	●	
32	78	60	24	34	Form "AD"	1.4	WSMH/32-60/HSK-A50	5103454	●	
16	38	100	17	74	Form "AD"	1.2	WSMH/16-100/HSK-A50	5103457	●	
22	48	100	19	74	Form "AD"	1.6	WSMH/22-100/HSK-A50	5103459	●	
27	58	100	21	74	Form "AD"	1.9	WSMH/27-100/HSK-A50	5103461	●	
32	78	100	24	74	Form "AD"	2.7	WSMH/32-100/HSK-A50	5103462	●	

HSK-A63										Verfügbarkeit Availability
d (mm)	D (mm)	A (mm)	L1 (mm)	L3 (mm)	Kühlmittelezufuhr Coolant supply	N/W (kg)	Bezeichnung Designation	Ident No.		
16	38	50	17	24	Form "AD"	1.1	WSMH/16-50/HSK-A63	4601763	●	
22	48	50	19	24	Form "AD"	1.1	WSMH/22-50/HSK-A63	4601765	●	
27	58	60	21	34	Form "AD"	1.3	WSMH/27-60/HSK-A63	4601767	●	
32	78	60	24	34	Form "AD"	1.4	WSMH/32-60/HSK-A63	4601769	●	
40	88	60	27	34	Form "AD"	1.9	WSMH/40-60/HSK-A63+*	4601771	●	
16	38	100	17	74	Form "AD"	1.4	WSMH/16-100/HSK-A63	4601764	●	
22	48	100	19	74	Form "AD"	1.8	WSMH/22-100/HSK-A63	4601766	●	
27	58	100	21	74	Form "AD"	2.0	WSMH/27-100/HSK-A63	4601768	●	
32	78	100	24	74	Form "AD"	2.6	WSMH/32-100/HSK-A63	4601770	●	
40	88	100	27	74	Form "AD"	3.1	WSMH/40-100/HSK-A63+*	4601772	●	

HSK-A100										Verfügbarkeit Availability
d (mm)	D (mm)	A (mm)	L1 (mm)	L3 (mm)	Kühlmittelezufuhr Coolant supply	N/W (kg)	Bezeichnung Designation	Ident No.		
16	38	50	17	21	Form "AD"	2.3	WSMH/16-50/HSK-A100	5056120	●	
22	48	50	19	21	Form "AD"	2.5	WSMH/22-50/HSK-A100	4601663	●	
27	58	50	21	21	Form "AD"	2.7	WSMH/27-50/HSK-A100	4601664	●	
32	78	50	24	21	Form "AD"	2.8	WSMH/32-50/HSK-A100	4601665	●	
40	88	60	27	31	Form "AD"	3.8	WSMH/40-60/HSK-A100+*	4601666	●	
60	129	70	40	41	Form "AD"	6.0	WSMH/60-70/HSK-A100+	5056122	●	

Ersatzteile und Zubehör / Spare Parts & Accessories: Pg.D8 Pg.E3 Pg.E4 Pg.E4 Pg.D8

- Kühlbohrung an der Stirnseite Standard bei allen Grundhaltern
- + ID = Ø 40, D = Ø 60 Mit 4 zusätzlichen Gewindebohrungen nach DIN 2079
- Kühlmittelrohr bitte separat bestellen (Siehe Seite D8)
- Im Lieferumfang enthalten: Mitnehmersteine, Fräseranzugsschraube und Spanschrauben (DIN 912)
- * Im Lieferumfang enthalten: Spanschrauben (DIN 912 & DIN 6367)
- Spanschrauben (DIN6367) bitte separat bestellen (Siehe Seite E3)

- Coolant bore on the pilot face (holder with Form "AD") as standard for all holders
- + ID = Ø 40, d = Ø 60 With additional 4 screw holes to DIN 2079
- Please order coolant tube separately (See page D8)
- Delivery includes : Drive keys, clamping screw and locking screw(DIN 912)
- * Delivery includes : Locking screw (both DIN 912 & DIN 6367)
- Please order locking screw (DIN6367) separately (refer page E3)

Das gesamte Aufnahmen Sortiment mit Ersatzteilen entnehmen Sie dem Bilz-Katalog
 CNC Grip / Thermo Grip www.bilz.de
 The complete chuck range also the spare parts refer to the Bilz- catalog
 CNC Grip / Thermo Grip www.bilz.de

- Verfügbar ab Lager Available from stock
- kurzfristig lieferbar available at short notice

T... HSK-A63, DIN69893

Schrumpffutter für (BE Typen)

Shrink Chucks for (BE Typs)

www.boehlerit.com

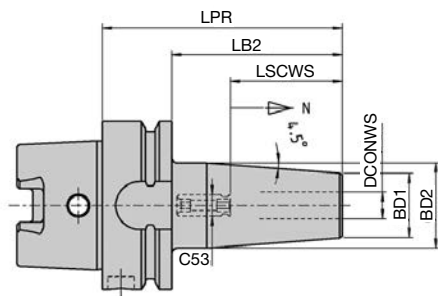

T... HSK-A63													
D1 [mm]	A [mm]	L3 [mm]	D2 [mm]	D3 [mm]	L1 [mm]	N [mm]	G	Bezeichnung Designation	Ident No.	Verfügbarkeit Availability			
3	80	54	15	20	20	5	M6	T0300/HSK-A63	6726618	○			
4	80	54	15	20	20	5	M6	T0400/HSK-A63	6726619	○			
5	80	54	15	20	25	5	M6	T0500/HSK-A63	6726620	○			
6	80	54	21	27	36	10	M5	T0600/HSK-A63	6726201	○			
8	80	54	21	27	36	10	M6	T0800/HSK-A63	6726202	○			
10	85	59	24	32	42	10	M8x1	T1000/HSK-A63	6726203	●			
12	90	64	24	32	47	10	M10x1	T1200/HSK-A63	6726204	●			
14	90	64	27	34	47	10	M10x1	T1400/HSK-A63	6726205	○			
16	95	69	27	34	50	10	M12x1	T1600/HSK-A63	6726206	●			
18	95	69	33	42	50	10	M12x1	T1800/HSK-A63	6726211	○			
20	100	74	33	42	52	10	M16x1	T2000/HSK-A63	6726207	●			
25	115	89	44	52,5	58	10	M16x1	T2500/HSK-A63	6726208	●			
32	120	94	44	52,5	62	10	M16x1	T3200/HSK-A63	6726209	●			
6	120	94	21	27	36	10	M5	T0600-120/HSK-A63	6726388	○			
8	120	94	21	27	36	10	M6	T0800-120/HSK-A63	6726391	○			
10	120	94	24	32	42	10	M8x1	T1000-120/HSK-A63	6726392	○			
12	120	94	24	32	47	10	M10x1	T1200-120/HSK-A63	6726410	○			
14	120	94	27	34	47	10	M10x1	T1400-120/HSK-A63	6726401	○			
16	120	94	27	34	50	10	M12x1	T1600-120/HSK-A63	6726399	○			
18	120	94	33	42	50	10	M12x1	T1800-120/HSK-A63	6726539	○			
20	120	94	33	42	52	10	M16x1	T2000-120/HSK-A63	6726662	○			
25	120	94	44	52,5	58	10	M16x1	T2500-120/HSK-A63	6726416	○			
6	160	134	21	32	36	10	M5	T0600-160/HSK-A63	6726411	○			
8	160	134	21	32	36	10	M6	T0800-160/HSK-A63	6726402	○			
10	160	134	24	34	42	10	M8x1	T1000-160/HSK-A63	6726403	○			
12	160	134	24	34	47	10	M10x1	T1200-160/HSK-A63	6726404	○			
14	160	134	27	42	47	10	M10x1	T1400-160/HSK-A63	6726405	○			
16	160	134	27	42	50	10	M12x1	T1600-160/HSK-A63	6726406	○			
18	160	134	33	51	50	10	M12x1	T1800-160/HSK-A63	6726407	○			
20	160	134	33	51	52	10	M16x1	T2000-160/HSK-A63	6726468	○			
25	160	134	44	52,5	58	10	M16x1	T2500-160/HSK-A63	6726408	○			
32	160	134	44	52,5	62	10	M16x1	T3200-160/HSK-A63	6726409	○			
	5025376			6738421									

Das gesamte Aufnahmen Sortiment mit Ersatzteilen entnehmen Sie dem Bilz-Katalog
 CNC Grip / Thermo Grip www.bilz.de
 The complete chuck range also the spare parts refer to the Bilz- catalog
 CNC Grip / Thermo Grip www.bilz.de

● Verfügbar ab Lager Available from stock
 ○ kurzfristig lieferbar available at short notice

T... HSK-A100, DIN69893

Schrumpffutter (für BE Typen)

Shrink Chucks for (BE Typs)

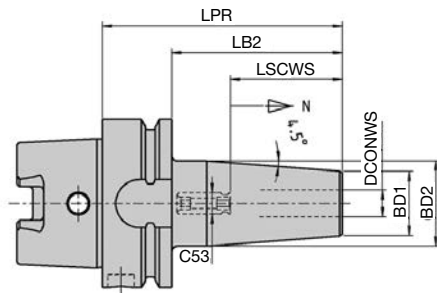

T... HSK-A100													Verfügbarkeit Availability
D1 [mm]	A [mm]	L3 [mm]	D2 [mm]	D3 [mm]	L1 [mm]	N [mm]	G	Bezeichnung Designation	Ident No.				
6	85	56	21	27	36	10	M5	T0600/HSK-A100	6726342	○			
8	85	56	21	27	36	10	M6	T0800/HSK-A100	6726343	○			
10	90	61	24	32	42	10	M8x1	T1000/HSK-A100	6726344	●			
12	95	66	24	32	47	10	M10x1	T1200/HSK-A100	6726345	●			
14	95	66	27	34	47	10	M10x1	T1400/HSK-A100	6726346	○			
16	100	71	27	34	50	10	M12x1	T1600/HSK-A100	6726347	●			
18	100	71	33	42	50	10	M12x1	T1800/HSK-A100	6726348	○			
20	105	76	33	42	52	10	M16x1	T2000/HSK-A100	6726349	●			
25	115	86	44	53	58	10	M16x1	T2500/HSK-A100	6726350	●			
32	120	91	44	53	62	10	M16x1	T3200/HSK-A100	6726351	●			
6	120	91	21	27	36	10	M5	T0600-120/HSK-A100	6726478	○			
8	120	91	21	27	36	10	M6	T0800-120/HSK-A100	6726479	○			
10	120	91	24	32	42	10	M8x1	T1000-120/HSK-A100	6726755	○			
12	120	91	24	32	47	10	M10x1	T1200-120/HSK-A100	6726480	○			
14	120	91	27	34	47	10	M10x1	T1400-120/HSK-A100	6726833	○			
16	120	91	27	34	50	10	M12x1	T1600-120/HSK-A100	6726820	○			
18	120	91	33	42	50	10	M12x1	T1800-120/HSK-A100	6727035	○			
20	120	91	33	42	52	10	M16x1	T2000-120/HSK-A100	6726821	○			
25	120	91	44	53	58	10	M16x1	T2500-120/HSK-A100	6727037	○			
6	160	131	21	32	36	10	M5	T0600-160/HSK-A100	6726645	○			
8	160	131	21	32	36	10	M6	T0800-160/HSK-A100	6726646	○			
10	160	131	24	34	42	10	M8x1	T1000-160/HSK-A100	6726647	○			
12	160	131	24	34	47	10	M10x1	T1200-160/HSK-A100	6726648	○			
14	160	131	27	42	47	10	M10x1	T1400-160/HSK-A100	6726649	○			
16	160	131	27	42	50	10	M12x1	T1600-160/HSK-A100	6726650	○			
18	160	131	33	51	50	10	M12x1	T1800-160/HSK-A100	6727036	○			
20	160	131	33	51	52	10	M16x1	T2000-160/HSK-A100	6726643	○			
25	160	131	44	60	58	10	M16x1	T2500-160/HSK-A100	6726644	○			
32	160	131	44	60	62	10	M16x1	T3200-160/HSK-A100	6727038	○			
		5028428				6738303							

Das gesamte Aufnahmen Sortiment mit Ersatzteilen entnehmen Sie dem Bilz-Katalog
 CNC Grip / Thermo Grip www.bilz.de
 The complete chuck range also the spare parts refer to the Bilz- catalog
 CNC Grip / Thermo Grip www.bilz.de

● Verfügbar ab Lager Available from stock
 ○ kurzfristig lieferbar available at short notice

Neuheiten News

- **Torx®** - Schraubendreher mit selbsteinstellendem Drehmoment für jede Torx-Größe
Torque wrench® with self-regulating torque load for each torx-size.
- **DINA PLUS®** Torx-Schraubendreher Kit
DINA PLUS® torque wrench kit





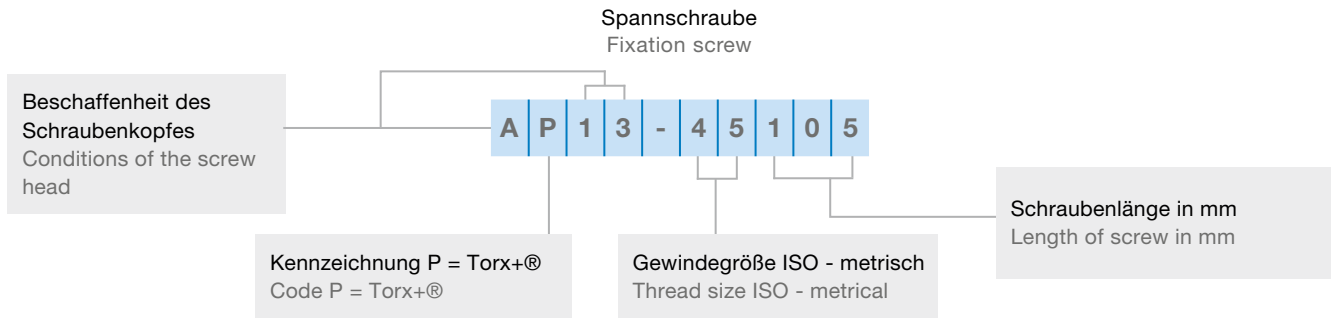

Technische Hinweise
Technical hints
Anhang
Attachment

Ersatzteile - Schrauben



Spare parts - Screws



Ersatzteile Spare parts				Frässystem Milling system														
				Plitec 45N	ETAtec 45P	THETAtec 45N	ISO 45P	BETAtec 90P Feed	DELTAtec 90P Feed	DELTAtec 90N	DELTAtec 90N Tang	ISO 90P	THETAtec 88N	ZETAtec 90N	BALLtec	ISO 00P	RHOMBICtec 95P	VARIOtec
Artikelbezeichnung Item code	Bestell-Nr. Ordering No.	Montagewerkzeug Mounting tool	Anzugsmoment torque															
A02-30076	5084082	T9	2 Nm															
A02-60160	6401270	T25	6 Nm	•														
AP02-18041	5149563	IP6	0,9 Nm															
AP02-22052	5142537	IP7	1,2 Nm															
AP02-25051	5091691	IP8	1,5 Nm															
AP02-25064	5127961	IP7	1,5 Nm															
AP02-25068	5085706	IP8	2 Nm															
AP02-30083	5112357	IP9	2 Nm															
AP02-35100	5092669	IP15	3,5 Nm															
AP02-40054	5085714	IP15	3 Nm		•													
AP02-40082	5122796	IP15	3 Nm		•													
AP02-40095	5085711	IP15	3 Nm															
AP02-50108	5112356	IP20	5 Nm															
AP06-40115	5131917	IP20	5 Nm	•		•												
AP12-25063	5118702	IP7	1,4 Nm															
AP12-30077	5118703	IP8	2,5 Nm															
AP12-35095	5118704	IP10	3,5 Nm															
AP12-40133	5118705	IP15	5,0 Nm															
AP12-50162	5118706	IP20	7,0 Nm															
AP12-60200	5118707	IP25	8,0 Nm															
AP12-80250	5118709	IP40	20,0 Nm															
AP13-18037	5118116	IP6	0,6 Nm															
AP13-25055	5118117	IP7	1,4 Nm															
AP13-35072	5118118	IP15	3,5 Nm															
AP13-35086	5118120	IP15	3,5 Nm															
AP13-40110	5084084	IP15	3 Nm															
AP13-45105	5118121	IP15	5,5 Nm															
AP13-45108	5085713	IP20	5 Nm															
AP17-25055	5085710	IP8	2 Nm															
AP17-25056	5150331	IP7	1,2 Nm															
Spannschraube Clamping screw RD12	5125841	IP15	5,0 Nm															
Spannsystem Clampingsystem RD16	5125842 5118121	IP15	5,0 Nm															
AP02-35121	5134447	IP15	5,0 Nm															
Schraube U-Platte Screw, shim	5171188	SW 3,5	3,0 Nm															
AP13-45110	5172494	IP20	5,0 Nm															
AP13-25063	5138229	IP8	2,0 Nm															
Differ.Schraube Dif. Screw SD10	5127661	SW 5	-															
Differ.Schraube Dif. Screw SD14	5111638	SW 6	-															

	Ersatzteile Spare parts		Frässystem Milling system
	Artikelbezeichnung Item code	Bestell-Nr. Ordering No.	BULLtec®
	Spannschraube für Kassette Fixation screw for cartridge	5049762	•
	Spannkeil Wedge clamp	5132639	•
	Spannschraube für Spannkeil Fixation screw for wedge clamp	5132480	•
	Drehmomentschlüssel Torque wrench	5136235	•

Ersatzteile - KAPPAtec
Spare parts - KAPPAtec

Ersatzteile für Planfräskopf 55° PN.. 13 Spare parts for face milling cutter 55° PN.. 13			
			
Spannschraube für Wendeschneidplatte Fräser DM 80-125 Clamping screw for indexable insert A02-80240 5222056	Spannschraube für Wendeschneidplatte Fräser DM 160-315 Clamping screw for indexable insert A02-120440 5222058	Spannschraube für die Unterlegsplatte Clamping screw for shim AP02-40086 5198554	Unterlegsplatte Shim 5083795

DINA PLUS Torx®- Schraubendreher Kit
 DINA PLUS torque® - Wrench kit

Besondere Merkmale:

- selbststellendes Drehmoment für jede Torx-Größe, dank speziellem System (kein manuelles Einstellen notwendig)
- große Vielfalt an farbig markierten Einsteckklingen (T6 -T20 / IP6 - IP20)
- 100 % Lösemoment beim Öffnen der Schraube verfügbar
- hohe Lebensdauer dank eloxiertem Aluminiumgriff

Special features:

- self-regulating torque for each torx-size, due to special system (no self-adjustment required)
- huge range of colour-marked blades (T6 -T20 / IP6 - IP20)
- 100 % torque availability when loosening screws
- long tool life through anodised aluminium handle



Bezeichnung Designation			Artikelnummer Ordering code		
DINA PLUS® Kit / (1 Griff + 14 Einsätze pro Packung 1 handle + 14 blades in a box)			5126413		
DINA PLUS® Griff Handle			5126415		
Torx® Klinge / blade		Torx® PLUS Klinge / blade			
Größe Size	Anzugsmoment Nm max. torque Nm max.	Artikelnummer Ordering code	Größe Size	Anzugsmoment Nm max. torque Nm max.	Artikelnummer Ordering code
T6	0,6 Nm	5126416	IP6	0,6 Nm	5126423
T7	0,9 Nm	5126417	IP7	0,9 Nm	5126425
T8	1,2 Nm	5126418	IP8	1,2 Nm	5126426
T9	1,4 Nm	5126419	IP9	1,4 Nm	5126427
T10	2,0 Nm	5126420	IP10	2,0 Nm	5126428
T15	3,0 Nm	5126421	IP15	3,0 Nm	5126429
T20	5,0 Nm	5126422	IP20	5,0 Nm	5126430
Verfügbare Drehmomente können von vorgeschlagenen Anzugsmomenten abweichen. Available torques can deviate from suggested tightening torque.					

Ersatzteile Spare parts		Frässystem Milling system												
		Plitec 45N	ETAttec 45P	THETAttec 45N	ISO 45P	BETAttec 90P Feed	DELTAtec 90P Feed	DELTAtec 90N	DELTAtec 90N Tang	ISO 90P	THETAttec 88N	ZETAttec 90N	BALLtec	ISO 00P
Bezeichnung Designation	Artikelnummer Ordering code													
T6	5118122													
T7	5121167													
T9	5088515							●						
T10	5088516													
T25	5088518	●						●						
IP6	5126412					●								●
IP7	5118123							●			●	●	●	●
IP8	5088519					●				●		●		
IP9	5118124							●						
IP10	5118726											●		
IP15	5088520		●			●		●	●	●	●	●	●	
IP20	5088521	●		●	●					●		●		
IP25	5118727											●		
IP40	5118728											●		

Torx-Kit_2 Schraubendreher & Drehmoment & Drehmomenteinsätze
Torx-Kit_2 wrench & Torque & Torque wrench insets



Bezeichnung Designation		Ident.-Nr. Ident.-No	
Torx-Kit_2		5151259	
Torx-Kit_2 beinhaltet folgende Artikel: includes the following parts:			
Griffe Handle	Drehmomenteinsätze Torque wrench insets	Bit Torx 25mm	Bit Torx Plus 50mm
Quergriff Cross handle (1) Kraftgriff Power handle (2)	0,6 Nm	T6	6IP
	0,9 Nm	T7	7IP
	1,2 Nm	T8	8IP
	1,4 Nm	T9	9IP
	2,0 Nm	T10	10IP
	3,0 Nm	T15	15IP



Ersatzteile
Spare parts

Drehmomenteinsätze Torque wrench insets		
Bezeichnung Designation	Einsatz für Inserts for	Ident.-Nr. Ident.-No.
0,6 Nm	T6, IP6	5151263
0,9 Nm	T7, IP7	5151265
1,2 Nm	T8, IP8	5151266
2,0 Nm	T8, IP8	5151267
1,4 Nm	T9, IP9	5151268
2,0 Nm	T9, IP9	5151269
2,0 Nm	T10, IP10	5151270
3,0 Nm	T15, IP15	5151271
5,0 Nm	T20, IP20	5151272
5,5 Nm	T20, IP20	5151273

Bits			
Bit Torx 25mm		Bit Torx Plus 50mm	
Bezeichnung Designation	Ident.-Nr. Ident.-No.	Bezeichnung Designation	Ident.-Nr. Ident.-No.
T6	5151274	6IP	5151281
T7	5151275	7IP	5151282
T8	5151276	8IP	5151283
T9	5151277	9IP	5151284
T10	5151278	10IP	5151285
T15	5151279	15IP	5151286
T20	5151280	20IP	5151287

Griffe Handle	
Bezeichnung Designation	Ident.-Nr. Ident.-No.
Quergriff Cross handle (1)	5151260
Kraftgriff Power handle (2)	5151262

Aufsteckfräser Face Milling Cutter			
Schrägungswinkel W_1 max beim Rampe eintauchen (Ramping) Bevel angle W_1 max. for plunge milling "ramping"			
	BF45	BF90	
d	12,7	6,65	9,52
b	1,4		
$a_{p,max}$	5,5	8	14
d_1 mm	W_1 max Grad Degree		
40	8,5	1,0	1,5
50	6,5	0,8	1,1
63	5,0	0,6	0,8
80	3,5	0,5	0,6
100	3,0		0,5
innere Schnitttiefe: internal cutting depth: $0,7 \times a_{p,max}$			

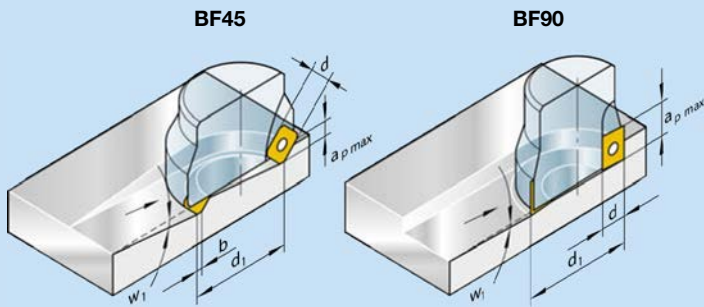

Schaftfräser End milling cutter			
Schrägungswinkel W_1 max beim Rampe eintauchen (Ramping) Bevel angle W_1 max. for plunge milling "ramping"			
	BE90		
d_1	l_2	d	W_1 max Grad Degree
16	8	6,65	3,0
20	8	6,65	2,1
25	8	6,65	1,5
25	14	9,52	2,8
32	14	9,52	2,0
40	14	9,52	1,5

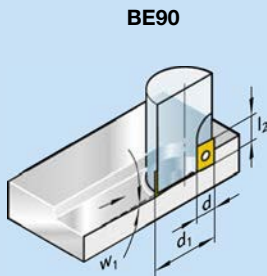

Formeln
Formulas

Drehzahl Revolutions n (min^{-1}): $n = \frac{v_c \cdot 1000}{\pi \cdot d_1}$	Schnittgeschwindigkeit Cutting speed v_c (m/min): $v_c = \frac{n \cdot \pi \cdot d_1}{1000}$	v_c = Schnittgeschwindigkeit Cutting speed (m/min) n = Drehzahl (min^{-1}) Revolution (min^{-1}) d_1 = Fräser-Durchmesser-(mm) Cutter diameter (mm) v_f = Vorschubgeschwindigkeit Feed rate (mm/min) f_z = Vorschub pro Zahn Feed per tooth (mm) P_e = Antriebsleistung Drive power z_{eff} = Effektive Zähnezahl effective number of teeth Q = Spanvolumen Chip volume (cm^3/min) a_e = Schnittbreite Width of cut (mm) a_p = Schnitttiefe Depth of cut (mm) LF = Leistungsfaktor Efficiency factor ($\text{cm}^3/\text{min}/\text{kW}$)
Vorschubgeschwindigkeit Feed rate V_f (mm/min): $V_f = f_z \cdot Z_{eff} \cdot n$	Vorschub pro Zahn Feed per tooth f_z (mm): $f_z = \frac{V_f}{Z_{eff} \cdot n}$	
Spanvolumen Chip volume-Q (cm^3/min): $Q = \frac{a_e \cdot a_p \cdot V_f}{1000}$	Antriebsleistung Drive power P_e (kW): $P_e = \frac{Q}{LF}$	

Mittige Anordnung Centerline location	
$\varphi_s = 2 \cdot \sin^{-1} \left(\frac{a_e}{d_1} \right)$	

Kanten fräsen Edge milling	
$\varphi_s = \sin^{-1} \left(\frac{a_e - \frac{d_1}{2}}{\frac{d_1}{2}} \right) + 90$	

Versetzt fräsen Adjusted milling	
$\sin \varphi_1 = \frac{2 \times \left(\frac{d_1}{2} - a_{ue} \right)}{d_1}$ $\sin \varphi_2 = \frac{2 \times (a_e - a_{e1})}{d_1}$ $\sin \varphi_s = \sin \varphi_1 + \sin \varphi_2$	

Maße und Einheiten Dimensions and units	Anwendungsformeln Application formulas	
a_p = Schnitttiefe in mm Depths of cut in mm a_e = Schnittbreite in mm Width of cut in mm l = Bearbeitete Länge in mm Machined length in mm h_m = Mittenspanndicke in mm Medium chip thickness v_c = Schnittgeschwindigkeit in m/mm Cutting speed in m/mm f_z = Vorschub pro Zahn in mm Feed per tooth in mm d_1 = Äußerer Werkzeugdurchmesser External tool diameter d_e = Effektiver Durchmesser, Schnittkreisdurchmesser in mm Effective diameter with different inserts and at specified cut depth in mm d = Durchmesser der Platte in mm Insert diameter in mm z = Anzahl der Schneiden am Werkzeug Number of tool cutting edges k = Einstellwinkel Setting angle φ_s = Eingriffswinkel Approach angle	Umdrehungen pro Minute n [U/min] Revolutions per minute n [rpm]	Mittlere Spandicke h_m [mm] Medium chip thickness h_m [mm]
	$n = \frac{v_c \times 1000}{\pi \cdot d_e}$	$h_m = f_z \times \frac{a_e}{d_e}$
	Vorschubgeschwindigkeit v_f [mm/min] Feed rate v_f [mm/min]	gültig nur bis valid only up to $\frac{a_e}{d_e} < 0,3$ bzw. 30% oder $\varphi = 60^\circ$ sonst otherwise $h_m = \frac{360 \times f_z \times a_e \times \sin(k)}{\pi \cdot d_e \varphi_s}$
	$v_f = f_z \cdot n \cdot z$	
	Vorschub pro Umdrehung f [mm/U] Feed per revolution f [mm/rev]	Zerspanungsvolumen Q [cm ³ /min] Chip removal rate Q [cm ³ /min]
	$f = \frac{v_f}{n}$	$Q = \frac{a_p \times a_e \times v_f}{1000}$
	Vorschub pro Zahn f_z [mm/z] Feed per tooth f_z [mm/tooth]	Effektiver Schnittkreisdurchmesser [mm] Effective diameter of cutting [mm]
	$f_z = h_m \times \sqrt{\frac{d_e}{a_e}}$	$d_e = d_1 - d + 2 a_p \sqrt{d - a_p}$
	gültig nur bis valid only up to $\frac{a_e}{d_e} < 0,3$ bzw. 30 % oder $\varphi = 60^\circ$ respectively 30 % or $\varphi 60^\circ$	
	Einstellwinkel k Setting angle	Vorschub pro Zahn f_z Feed per tooth
	90°	f_z
	45°	$f_z \cdot 1,414$
	30°	$f_z \cdot 2$
	sonst otherwise $f_z = \frac{h_m \times \pi \times d_e \times \varphi_s}{360 \times a_e \times \sin(k)}$	

Abhilfe und Lösungen Removal and solutions	Problem Problem										
	Freiflächenverschleiß Flank wear	Kolkverschleiß Crater wear	Plattenabsplittierungen Flaking	Kammrisse Thermal cracks	Ermüdungsrisse Fatigue cracks	Plastische Verformung Plastic deformation	Kerbverschleiß Notch wear	Aufbauschneidenbildung Built-up edge	Schneidkantenbruch Cutting edge failure	Vibrationen Vibrations	Schlechte Oberflächenqualität Poor surface quality
Verschleißfestere HM-Sorte Carbide grade with higher wear resistance	•	•				•	•				•
Zähere HM-Sorte Tougher carbide grade			•	•	•				•		
Schnittgeschwindigkeit erhöhen Increase cutting speed			•					•			
Schnittgeschwindigkeit verringern Reduce cutting speed	•	•		•		•					
Vorschub pro Zahn erhöhen Increase feed per tooth	•							•		•	
Vorschub pro Zahn verringern Reduce feed per tooth			•	•	•	•	•		•		•
Fräserpositionierung ändern Change cutter position					•					•	
Kleinerer Fräserdurchmesser Smaller cutter diameter				•							
Stabilität verbessern Improve rigidity			•				•		•		
Verwendung einer beschichteten Sorte Use coated grade	•	•						•			
Kühlmittel verwenden Use coolant				•		•					

ISO 513	BZG	Deutschland Germany	Deutschland Germany	Europa Europe	Europa Europe	Italien Italy	
		W-Nr. Mat.-No.	DIN	W.-Nr. EN	DIN EN	UNI	
P - Stahl / P - steel Magnetweicheisen, Baustahl, Stahlguss, Einsatzstahl, Kugellagerstahl, Federstahl, Werkzeugstahl, Rostfreierstahl ferritisch/ martensitisch Magnetic steel, construction steel, steel castings, cementation steel, free cutting steel, heat treatable steel, bearing steel, spring steel, alloyed steel, stainless steel ferritic/ martensitic	P1	1.0037	St 37-2		S25GT	Fe360B	
		1.0044	St 44-2		S 235 JR	Fe430B	
		1.0050	St 50-2		E 295	Fe490	
		1.0060	St 60-2		E 335	Fe590	
		1.0301	C10		C10	C10	
		1.0401	C 15		C15	C15, C16, 1C15	
		1.0402	C 22		C22	C20, C21	
		1.0406	C25			C25	
		1.0420	GS-38				
		1.0501	C 35		C35	C35, 1C35	
		1.0503	C 45		C45	C45, 1C45	
		1.0511	C40			C40	
		1.0528	C30			C30	
		1.0535	C 55		C55	C55, 1C55	
		1.0540	C50			C50	
		1.0570	St 52-3		S 355 JR G3	Fe510B	
		1.0601	C 60		C60	C60, 1C60	
		1.0711	9S20		10S20	9S20	
		1.0715	9 SMn 28		11SMn30	9SMn28	
		1.0718	9 SMnPb 28		11SMnPb30	CF9SMnPb28	
		1.0722	10 SPb 20		10SPb20	CF10SPb20	
		1.0726	35 S 20		35S20	35S20	
		1.0736	9 SMn 36		11SMn37	9SMn36, CF9SMn36	
		1.0737	9 SMnPb 36		11SMnPb37	9SMnPb36, CF9SMnPb36	
		1.1013	RFe100				
		1.1014	RFe80				
		1.1015	RFe60				
		1.1141	Ck 15		C15E	C16	
		1.1157	40 Mn 4		40Mn4		
		1.1158	Ck 25		C25E		
		1.1167	36 Mn 5		36Mn5		
		1.1170	28 Mn 6		28Mn6	C28Mn	
		1.1183	Cf 35		C35G	C36, C38	
		1.1191	Ck 45		C45E	C45	
		1.1203	Ck 55		C55E	C50	
		1.1213	Cf 53		C53G	C53	
		1.1221	Ck 60		C60E	C60	
		1.1231	Ck67			C67	
		1.1248	Ck75			C75	
		1.1249	Cf70				
		1.1274	Ck 101		C101E, C100S	C100	
		1.1545	C 105 W 1		C105U	C100KU	
		1.1663	C 125 W		C125W, C125U		
		1.2067	100 Cr 6		99Cr6, 102Cr6		
		P2	1.0904	55 Si 7		56Si7	

Spanien Spain	Frankreich France	USA U.S.A.	Herstellerbezeichnung Brand Name
UNE	AFNOR	AISI/SAE	AISI / SAE
	E 24-2	1013	
	E 28-2	1021	
	A 50-2	A 570 (50)	
	A 60-2	A 572 (65)	
	C10	1010	
F.111	C18RR, XC18	J 409 Grade 1015	
1C22, F112	AF42C20, XC25, 1C22	1020	
	AF 50 C 30	1025	
		A 27	
F.113	C35,1C35,AF55,C35	1035	
F.114	1C45, AF 65 C 45	1045	
	AF 60 C 40	1040	
		1030	
F.115	C54, 1C55, AF 70 C 55	1055	
		1050	
		1024	
F.115	C60, 1C60, AF70C55	1060	
		1212	
F.2111 - 11SMn28	S250	1213	
F.2112 - 11SMnPb28	S250Pb	12L13, 12L14, J 403 Grade 12L14, J 1397 Grade 12L14	
10SPb20	10PbF2		
F.210G	35MF6	J 403 Grade 1141	
F.2113 - 12 SMn 35	S300	J 403 Grade 1213, J 403 Grade 1215, J 1392 Grade 1213	
F.2114 - 12 SMnPb 35	S300Pb	J 403 Grade 12L14, J 1397 Grade 12L14	
F.1511 - C 16 k, F.1110 - C 15 k	XC12	1015	
	35M5	1035, 1041	
F.1120 - C 25 k, C25K (F1120)	2C25	1025	
F.1203 - 36 Mn5	40M5	1335	
28Mn6	20M5	1027	
0	XC38H1TS	1035	
F1140-C45k, F1142-C48k	C45RR, XC42H1, XC45, 2C45, XC48, XC48H1	1045	
F.1150 - C 55 k	XC55H1, 2C55, XC54	1055	
	XC48H1TS	1050, 1055	
F.511, F.512	C60RR, XC60, 2C60	1060	
	XC 68	1070	
		1074	
	C100RR, C100, XC100, E 100	1095	
F515, F516	C105E2U, Y1105	W110	
F.5123 C120	Y2120	W112	
F.5230 100 Cr6, F.1310 - 100 Cr6, F.131	100Cr6RR, 100C6, Y100C6	L3, 52100, L1	
F.1440 - 56 Si 7	55S7	9255	

ISO 513	BZG	Deutschland Germany	Deutschland Germany	Europa Europe	Europa Europe	Italien Italy		
		W.-Nr. Mat.-No.	DIN	W.-Nr. EN	DIN EN	UNI		
P - Stahl / P - steel Magnetweicheisen, Baustahl, Stahlguss, Einsatzstahl, Nitierstahl, Nitterstahl, Automatenstahl, Vergütungsstahl, Kugellagerstahl, Federstahl, Werkzeugstahl, Rostfreierstahl ferritisch/ martensitisch Magnetic steel, construction steel, steel castings, cementation steel, nirtiding steel, free cutting steel, heat treatable steel, bearing steel, spring steel, alloyed steel, stainless steel ferritic/ martensitic	P2	1.2080	X 210 Cr 12		X210Cr12	X205Cr12KU		
		1.2311	40CrMnMo7		40CrMnNiMo8-6			
		1.2312	40CrMnMoS8-6		40CrMnNiMoS8-6-4			
		1.2365	32CrMoV12-28				30CrMoV12-27 KU	
		1.2419	105 WCr 6			107WCr5, 105WCr6, 100WCr6	107WCr5KU	
		1.2542	45 WCrV 7			45WCrV8, 45WCrV7	45WCrV8KU	
		1.2714	56NiCrMoV7			55NiCrMoV7		
		1.2738	40CrMnNiMo8-6-4					
		1.2767	45NiCrMo16				40NiCrMoV16 KU	
		1.2833	100 V 1			100V1	102V2KU	
		1.3505	100 Cr 6			100Cr6	100Cr6	
		1.3536	100CrMo7-3					
		1.5415	15 Mo 3			16Mo3	16Mo3 (KG KW)	
		1.5423	16 Mo 5			16Mo5	16Mo5KG, 16Mo5KW	
		1.5622	14 Ni 6			14Ni6	14Ni6KG, 14Ni6KT	
		1.5662	X 8 Ni 9			X8Ni9	X10Ni9, X12Ni09	
		1.5680	12 Ni 19			X12Ni5, 12Ni19		
		1.5710	36 NiCr 6			36NiCr6		
		1.5732	14 NiCr 10			14NiCr10	16NiCr11	
		1.5752	14 NiCr 14			15NiCr13		
		1.5919	15CrNi6			15CrNi6	16CrNi4	
		1.6511	36 CrNiMo 4			36CrNiMo4	38NiCrMo7 (KB)	
		1.6523	21NiCrMo2, 20NiCrMo2-2			21NiCrMo2	20NiCrMo2	
		1.6546	40 NiCrMo 22			40NiCrMo2-2, 40NiCrMo2KD	40NiCrMo2 (KB)	
		1.6580	30CrNiMo8			30CrNiMo8	30CrNiMo8	
		1.6582	34 CrNiMo 6			34CrNiMo6	35NiCrMo6KB	
		1.6587	18CrNiMo7-6			17CrNiMo6, 18CrNiMo7-6	18NiCrMo7	
		1.6657	14 NiCrMo 134			14NiCrMo13-4	15NiCrMo13	
		1.6773	36NiCrMo16				36NiCrMo16	
		1.7005	45Cr2				45Cr2	
		1.7015	15 Cr 3			15Cr2KD		
		1.7033	34 Cr 4			34Cr4	34Cr4(KB)	
		1.7034	37Cr4				36CrMn4	
		1.7035	41 Cr 4			41Cr4	41Cr4, 41Cr4KB	
		1.7043	38Cr4				38Cr4	
		1.7045	42 Cr 4			42Cr4	41Cr4	
		1.7108	60SiCr7				60SiCr8	
		1.7131	16 MnCr 5			16MnCr5	16MnCr5	
		1.7147	20MnCr5				20MnCr5	
		1.7176	55 Cr 3			55Cr3	55Cr3	
		1.7218	25 CrMo 4			25CrMo4	25CrMo4 (KB)	
		1.7220	34 CrMo 4			34CrMo4	34CrMo4KB, 35CrMo4, 35CrMo4F	

Spanien Spain	Frankreich France	USA U.S.A.	Herstellerbezeichnung Brand Name
UNE	AFNOR	AISI/SAE	AISI / SAE
F.5212 X210 Cr12	X200Cr12, Z200C12	D3	
			M200
	32CDV12-28	H10	W320
F.5233 105 WCr5, F.523	105WC13		
F.5241 45 WCrSi 8, F.524, F524145WCrSi 8	45WCrV8, 45WCrV20	S1	
			W500
			M238
	Y35NCD16		
	C105E2UV1, Y1105V, 100V2	W210	
F.5230 100 Cr6, F.1310-100 Cr 6, F.131	Y100C6, 100C6, 100Cr6	L3, 52100	
F.2601-16 Mo 3	15D3, 15Mo3	ASTM A20, GR	
F.2602-16Mo5		4520	
F.2641-15Ni6	16N6, 15N6, 15Ni6	ASTM A350 LF5	
F.2645-X8 Ni09	Z8N9, 9Ni490	ASTM A353	
	Z18N5, 5Ni390	2515, 2517	
	35NC6	3135	
F.1540-15NiCr11	14NC11	3415	
	14NC11, 12NC15, 14NC12, 13NiCr14	3310, 3415, 9314	
	16 NC 6	4320	
F.1280-35NiCrMo4	40NCD3, 36CrNiMo4, 35NCD5	9840	
F1552-20NiCrMo2, F1534-20NiCrMo3	20NCD2, 22NCD2	J 1268 Grade 8620H, 8620	
F1204-40NiCrMo2, F1205- 40NiCrMo2DF	40NCD2	8740	
	30CrNiMo8, 30NCD8		
F1272-40NiCrMo7, 34CrNiMo6	35NCD6, 34CrNiMo6, 34CrNiMo8	4340	
F.1560-14 NiCrMo13, F.156	18NCD6	4320	
F1560-14NiCrMo13, F.1569- 14NiCrMo131	16NCD13		
	12C3, 15Cr2, 18C3	5132	
F.8221-35 Cr 4, F.224	32C4, 34Cr4	5132	
	38 4	5135	
38Cr4, 38Cr41, 42Cr4, F.1202-42Cr4	42C4, 41Cr4	5140	
F1201, F1202, F1206, F.1202-42Cr4	42C4, 42C4TS	5140, 5140H	
	#NV	9262	
F.1515-16 MnCr5, F.151	16MC5, 16MC4, 16MnCr5	J 1268 Grade 4118H, C5115	
	20 MC 5	5120	
F.1431-55 Cr3, F.143	55Cr3, 55C3	5155	
F8372-AM26CrMo4, F8330- AM25CrMo4, F1256-30CrMo4-1, F.222	25CD4, 25CrMo4	4130	
F8331-AM34CrMo4, F8231-34CrMo4, F1250-35CrMo4, F1254-35CrMo4DF, F.125	35CD4, 34CrMo4, 35CD4 / 34CrMo5	4135, 4137, J 1268 Grade 4135H	

ISO 513	BZG	Deutschland Germany	Deutschland Germany	Europa Europe	Europa Europe	Italien Italy		
		W-Nr. Mat.-No.	DIN	W.-Nr. EN	DIN EN	UNI		
P - Stahl / P - steel Magnetweicheisen, Baustahl, Stahlguss, Einsatzstahl, Nitterstahl, Automatenstahl, Vergütungsstahl, Kugellagerstahl, Federstahl, Werkzeugstahl, Rostfreierstahl ferritisch/ martensitisch Magnetic steel, construction steel, steel castings, cementation steel, nitriding steel, free cutting steel, heat treatable steel, bearing steel, spring steel, alloyed steel, stainless steel ferritic/ martensitic	P2	1.7223	41 CrMo 4		41CrMo4	41CrMo4		
		1.7225	42 CrMo 4		42CrMo4	38CrMo4KB, 42CrMo4, G40CrMo4		
		1.7228	50CrMo4		50CrMo4	50CrMo4		
		1.7243	18CrMo4			18CrMo4		
		1.7262	15 CrMo 5		15CrMo5			
		1.7335	13 CrMo 4 4		13CrMo4-5	14CrMo3, 16CrMo3		
		1.7361	32 CrMo 12		32CrMo12	32CrMo12		
		1.7380	10 CrMo 9 10		10CrMo9-10	12CrMo9 (KW KG), G14CrMo9, 10		
		1.7715	14 MoV 6 3		14MoV6-3			
		1.8159	50 CrV 4, 51CrV4			50CrV4		
		1.8507	34CrAlMo5		34CrAlMo5-10	34CrAlMo7		
		1.8509	41 CrAlMo 7		41CrAlMo7	41CrAlMo7		
		1.8515	31CrMo12		31CrMo12	31CrMo12		
		1.8519	31CrMoV9		31CrMoV9	31CrMoV10		
		1.8523	39 CrMoV 13 9		39CrMoV13-9			
	P3	1.1269	Ck85				C85	
		1.2085	X33CrS16				35CrMo8 KU	
		1.2316	X36CrMo17				X37CrMoV5-1 KU	
		1.2343	X38CrMoV5-1				X37CrMoV5-1 KU	
		1.2344	X 40 CrMoV 5 1			X40CrMoV5-1	X40CrMoV511KU	
		1.2363	X 100 CrMoV 5 1			X100CrMoV5-1	X100CrMoV51KU	
		1.2379	X153CrMoV12					
		1.2436	X 210 CrW 12			X210CrW12-1, X210CrW12	X215CrW121KU	
		1.2567	X30WCrV5-3			X30WCrV5-3	X30WCrV5-3 KU	
		1.2581	X 30 WCrV 9 3			X30WCrV9-3	X30WCrV9-3 KU	
		1.2601	X 165 CrMoV 12			X165CrMoV12	X165CrMoW12KU	
		1.3243	S 6-5-2-5			HS6-5-2-5	HS6-5-2-5	
		1.3255	S 18-1-2-5			HS18-1-2-5	HS18-1-1-5	
		1.3343	S 6-5-2			HS6-5-2	HS6-5-2-5	
		1.3348	S 2-9-2			HS2-9-2	HS2-9-2	
		1.3355	S 18-0-1			HS18-0-1	HS18-0-1	
		1.3401	X 120 Mn 12			X120Mn12	G-X120Mn12	
		1.5021	48Si7				48Si7	
		1.5026	55Si7				55Si7	
		1.5027	60Si7				60Si7	
	1.7701	51CrMoV4				51CrMoV4		
	P4	1.4000	X 7 Cr 13			X6Cr13	X6Cr13	
		1.4001	X 7 Cr 14			X7Cr14	X6Cr13	
		1.4002	X6CrAl13			X6CrAl13	X6CrAl13	
		1.4005	X12CrS13				X12CrS13	
		1.4006	X 10 Cr 13, X 12 Cr 13			X12Cr13, X10Cr13	X12Cr13, X10Cr13	
		1.4016	X6Cr17			X6Cr17	X8Cr17	

Spanien Spain	Frankreich France	USA U.S.A.	Herstellerbezeichnung Brand Name
UNE	AFNOR	AISI/SAE	AISI / SAE
F8332-AM42CrMo4, F8232-42CrMo4, F1252-40CrMo4	42CD4TS	4140	
F8332-AM42CrMo4, F8232-42CrMo4, F1252-40CrMo4	42CD4, 42CrMo4	4140	
	50CrMo4	4150	
F.1551-12CrMo4	12CD4		
F.2631-14CrMo45	15CD3.05, 15CD4.05	A387 Grade 12Cl2, ASTM A182	
F.124.A	30CD12		
TU.H	12CD9.10, 10CrMo9-10, 10CrMo9-11	A387 Grade 22, A387 Grade 22Cl2, ASTM A182	
F.2621-13 MoCrV6			
F.1430-51CrV4	50CV4, 51CrV4, 50CrV4	6150	
	30 CAD 6.12	A355CI-D	
F.1740-41CrAlMo7	40CAD6.12	Nitralloy 135	
	30 CD 12	A/B	
	-		
	40CDV12		
	C90	1086	
			M314
			M303, M303HH
	Z38CDV5	H11	W300
F.5318 X40 CrMoV5	X40CrMoV5, Z40CDV5	H13, P20	
F.5227 X100 CrMoV5	X100CrMoV5, Z100CDV5	A2, D2	
		D2	K110
F.5213 X210 CrW12, F.521	X210CrW12-1, Z210CW12-01, Z 210 CW 12	D6	
	Z32WCV5	H14	
F.5323 X30 WCrV9	X30WCrV9, Z30WCV9	O1, H21	
F.5211 X160 CrMoV12			
F.5613 6-5-2-5	Z85WDKCV06- 05-05-04-02, Z90WDKCV06- 05-05-04-02	S7, M35	
F.5530 18-1-1-5	Z80WKCV18- 05-04-01	T4	
F.5603 6-5-2	Z85WDCV06- 05-04-02	M2	
F.5607 2-9-2	Z100DCWV09- 04-02-02	M7	
F.5520 18-0-1	Z80WCV18-04-01	T1	
F.82551-AM-X 120 Mn 12	Z120M12, Z120Mn12		
	55S7, 56SC7	9255	
	60Si7	9260	
F.3110-X6 Cr13	Z6013, Z6Cr13, Z8C12	403, 13/6	
F.8401-AM-X12 Cr13	Z3014, Z8C13FF	403, 410S, 429	
	Z 8 CA 12	405	
	Z 11 CF 13	416	
F.3401-X12 Cr13	Z12C13, Z12Cr13, Z10C13	410	N100
F.3113-X8 Cr17	Z8C17, Z6Cr17	430	N200

ISO 513	BZG	Deutschland Germany	Deutschland Germany	Europa Europe	Europa Europe	Italien Italy		
		W.-Nr. Mat.-No.	DIN	W.-Nr. EN	DIN EN	UNI		
P - Stahl / P - steel	P4		1.4021	X20Cr13			X20Cr13	
			1.4028	X30Cr13		X20Cr13	X30Cr13	
			1.4034	X 46 Cr 13		X46Cr13	X40Cr14	
			1.4057	X 20 CrNi 17 2		X19CrNi17-2, X17CrNi16-2	X16CrNi16	
			1.4104	X 12 CrMoS 17		X14CrMoS17	X10CrS17	
			1.4113	X 6 CrMo 17 1		X6CrMo17-1	X8CrMo17	
			1.4125	X105CrMo17		X105CrMo17	#NV	
			1.4313	X 4 CrNi 13 4		X3CrNiMo13-4	GX6CrNi13 04	
			1.4510	X3CrTi17				
			1.4512	X2CrTi12		X5CrTi12	X6CrTi12	
			1.4542	X5CrNiCuNb16-4				
			1.4545	X5CrNiCu15-5				
			1.4568	X7CrNiAl17-7				
			1.4718	X 45 CrSi 9 3		X45CrSi9-3-1	X45CrSi8	
			1.4724	X 10 CrAl 13, X 10 CrAlSi 13		X10CrAlSi13, X10CrAl13	X10CrAl12	
			1.4742	X 10 CrAl 18, X 10 CrAlSi 18		X10CrAl18, X10CrAlSi18	X8Cr17	
			1.4747	X 80 CrNiSi 20		X80CrNiSi20		
			1.4762	X 10 CrAl 24, X 10 CrAlSi 25		X10CrAl24, X10CrAlSi25	X16Cr26	
		P5		1.1118	GS-24Mn6			
				1.1120	GS-20Mn5			
				1.4027	G-X 20 Cr 14		GX20Cr14	
				1.5419	GS-22Mo4			
				1.5633	GS-24Ni8			
				1.5681	GS-10Ni19			
				1.6309	GS-20MnMoNi5-5			
				1.6571	GS-34CrNiMo6			
				1.6748	GS-40NiCrMo6-5-6			
				1.6750	GS-20NiCrMo3-7			
				1.6760	GS-22NiMoCr5-6			
				1.7231	G42CrMo4			
		1.7357	GS-17CrMo5-5					
		1.7379	GS-18CrMo9-10					

Spanien Spain	Frankreich France	USA U.S.A.	Herstellerbezeichnung Brand Name
UNE	AFNOR	AISI/SAE	AISI / SAE
	Z 20 C 13	420	N320
	Z 20 C 13	420	
F.3405-X46 Cr13	Z40C14, Z40Cr14, Z38C13M, Z44C14	420	T651
F.3427-X15 CrNi16, F.313, F3427-X19CrNi172	Z15CN16.02	431	N350
F3117-X10CrS17, F3413-X14CrMoS17	Z10CF17	430F, J 405 Grade 51435	N310
F3116-X6CrMo171	Z8CD17.01	434	
	Z 100 CD 17	440C	N695
	Z5CN13.4, Z4CND13.4M, Z6CN13-4, Z8CD17-01	CA6. 13/4	
	Z 3 CT 12	409	
	Z 7 CNU 15-05	630	N700
			N701
F.3220-X 4 ScrSi 09-03	Z45CS9	HNV3	H700
F.13152-X 10 CrAl13	Z10C13, Z13C13	405	
F.3153-X 10 CrAl 18	Z10CAS18, Z12CAS18	430	
F.3222-X 80CrSiNi20-02	Z80CSN20.02	HNV6	
F.3154-X 10 CrAl24	Z10CAS24, Z12CAS25	446	H100
	Z 20 C13M		,
		A757	
		A 217	

ISO 513	BZG	Deutschland Germany	Deutschland Germany	Europa Europe	Europa Europe	Italien Italy			
		W.-Nr. Mat.-No.	DIN	W.-Nr. EN Mat.-No. EN	DIN EN	UNI			
M - Rostfreier Stahl / M - stainless steel	Austenitisch, ferritisch + austenitisch Austenitic stainless steel, ferritic + austenitic steel (duplex)	M1	1.4301	X 5 CrNi 18 10		X5CrNi18-10+F3:F21A3F3: F23F3:F24A3F3:F23F3: FF3:F24	X5CrNi 18 10		
			1.4303	X4CrNi18-12			X8CrNi1812		
			1.4305	X 10 CrNiS 18 9		X8CrNiS18-9	X10CrNiS 18.09		
			1.4306	X 2 CrNi 19 11		X2CrNi19-11	"X3CrNi18 11, X2CrNi18 11, GX2CrNi19 10"		
			1.4308	G-X 6 CrNi 18 9		GX5CrNi19-10			
			1.4311	X 2 CrNiN 18 10		X2CrNiN18-10	X2CrNiN18 11		
			1.4319	X3CrNiN17-8			X10CrNi1809		
			1.4401	X 5 CrNiMo 17 12 2		X5CrNiMo17-12-2, X4CrNiMo17-12-2, X5CrNiMo18-10	X5CrNiMo17 12		
			1.4404	X2CrNiMo17-12-2		X3CrNiMo17-12-2	X2CrNiMo1712		
			1.4408	G-X 6 CrNiMo 18 10		GX5CrNiMo19-11-2			
			1.4429	X 2 CrNiMoN 17 13 3		X2CrNiMoN17-13-3	X2CrNiMoN17 13		
			1.4435	X 2 CrNiMo 18 14 3, X 2 CrNiMo 18 12		X2CrNiMo18-14-3	X2CrNiMo17 13		
			1.4438	X 2 CrNiMo 18 16 4		X2CrNiMo18-15-4	X2CrNiMo18 16		
			1.4460	X 4 CrNiMoN 27 5 2		X3CrNiMoN27-5-2	X 3 CrNiMo 27 5 2		
			1.4541	X 6 CrNiTi 18 10		X6CrNiTi18-10	X6CrNiTi18 11		
			1.4550	X 6 CrNiNb 18 10		X6CrNiNb18-10	X6CrNiNb18 11		
			1.4558	X 2 NiCrAlTi 32 20		X2NiCrAlTi32-20			
			1.4563	X 1 NiCrMoCu 31 27 4		X1NiCrMoCu31-27-4			
			1.4571	X 6 CrNiMoTi 17 12 2		X6CrNiMoTi17-12-2	X6CrNiMoTi1712		
			1.4565, 1.4581	G-X 5 CrNiMiNb 18 10					
			1.4583	X 10 CrNiMoNb 18 12		X10CrNiMoNb18-12	X6CrNiMoNb		
			1.4828	X 15 CrNiSi 20 12		X15CrNiSi20-12	X16CrNi23 14		
			1.4841	X15CrNiSi25-20			X22CrNiSi2520		
			1.4878	X 12 CrNiTi 18 9		X12CrNiTi18-9, X10CrNiTi18-10	X6CrNiTi1811		
			1.4864	X 12 NiCrSi 36 16		X12NiCrSi36-16, X12NiCrSi35-16			
			1.4958	X 5 NiCrAlTi31-20		X5NiCrAlTi31-20			
			1.4977			X 40 CoCrNi 20 20			
			M2	1.4362	X2CrNiN23-4 (Ally 2304)				
				1.4462	X2CrNiMoN22-5-3		X2CrNiMoN22-5-3	X2CrNiMoN22-5-3	
				1.4501	X2CrNiMoCuWN25-7-4			X2CrNiMoCu WN25-7-4	
				1.4871	X 53 CrMnNiN 21 9		X53CrMnNiN21-9	X53CrMnNiN21 9	
				1.4310	X 12 CrNi 17 7		X9CrNi18-8, X10CrNi18-8	X12CrNi17 07	

Spanien Spain	Frankreich France	USA U.S.A.	Herstellerbezeichnung Brand Name
UNE	AFNOR	AISI/SAE	AISI / SAE
F.3451-X5 CrNi18-10, F.314, F.3504-X6CrNi19 10, F3504-X5CrNi1810"	Z6CN18.09	304	A500
		305	
F.3508-X10CrNiS18-09	Z10CNF18.09	303	A506
F.3503-X 2CrNi19-10, F3503-X 2CrNi18-10	Z1CN18-12, Z2CN18-10, Z3CN19.10M, Z3CN18-10, Z3CN19-11, Z3CN19-11FF	304L	A600
	Z6CN18.10M	---	
F3541-X2CrNiN1810	Z2CN18.10	304LN	
		302	
F.3543-X5CrNiMo17-12, F.3543-X6 CrNiMo17- 12-03, F3543-X5CrNiMo17-122"	Z6CND17.11	316	A120
			A200
F.8414-AM-X7 CrNiMo20 10			
F3543- X2CrNiMoN17133	Z2CND17.13	316LN	
F.3533-X2 CrNiMo 17- 12-03, F.3534-X6 CrNiMo 17- 12-03"	Z2CND17.13, Z3CND17-12-03, Z3CND18-14-03		A220
F3539-X2CrNiMo18164	Z2CND19.15	317L	
F3309-X8CrNiMo27-05, F3552-X8CrNiMo266	Z3CND25-07Az, Z5CND27-05Az	S32900	
F.3553-X7 CrNiTi 18-11, F.3523-X 6 CrNiTi 18-11, 09 Ch 18N10T, F3523-X6CrNiTi1810	Z6CNT18.10	321	
F.3552-X 7 CrNiNb 18-11, F.3524-X 67 CrNiNb 18-11, F3524-X6CrNiNb1810	Z6CNNb18.10	347	
		N08800 Incoloy 800	
		N08028 Alloy 28	
F.3552-X 6 CrNiMoTi17-12-03, F3535- X6CrNiMoTi17122	Z6NDT17.12	316Ti	A300
	Z6CNDNb	318	
F3312-X15CrNiSi20-12	Z15CNS20.12	309	
			H525
F.3523-X 6CrNiTi 18 11	Z6CNT18.12B	321	
F.3313-X12 CrNi 36-16	Z12NCS35.16	330	
	Z 42 CNKDWNb		
		S32304	Duplex
	Z 2 CND 22.05 Az	S31803	Duplex, A903
			Super Duplex
F.3217-X53 CrMnNiN 21-09	Z52CMN21.09	EV8	
F.3517-X12CrNi17 07	Z12CN17.07, Z12CN18.07, Z11CN17-08, Z11CN18-08, Z12CN18-09	301	

ISO 513	BZG	Deutschland Germany	Deutschland Germany	Europa Europe	Europa Europe	Italien Italy		
		W-Nr. Mat.-No.	DIN	W.-Nr. EN Mat.-No. EN	DIN EN	UNI		
K - Gusswerkstoffe / K - cast iron materials Grauguss, Kugelgraphitguss, Kugelgraphitguss GJS, Temperguss, Gusseisen mit Vermiculargrafit Grey cast iron, nodular cast iron, tempered cast iron, austempered ductile iron	K1	0.6010	GG-10, GG 10	EN-JL 1010	EN-GJL-100	G10		
		0.6015	GG-15, GG 15	EN-JL 1020	EN-GJL-150	G15		
		0.6020	GG-20, GG 20	EN-JL 1030	EN-GJL-200	G20		
		0.6025	GG-25, GG 25	EN-JL 1040	EN-GJL-250	G25		
		0.6030	GG-30, GG 30	EN-JL 1050	EN-GJL-300	G30		
		0.6035	GG-35, GG 35	EN-JL 1060	EN-GJL-350	G35		
		0.6040	GG-40, GG 40		EN-GJL-400			
		0.6660	GGL-NiCr 20 2					
			GG-26Cr, GG 26Cr		EN-GJL-260 Cr			
	K2		GGV 45			EN-GJV-450		
		0.7040	GGG-40	EN-JS 1040		EN-GJS-400-15	GS400-12	
		0.7050	GGG-50	EN-JS 1050		EN-GJS-500-7	GS500-7	
		0.7060	GGG-60	EN-JS 1060		EN-GJS-600-3, EN-GJS-600-3U	GS600-3	
		0.7070	GGG-70	EN-JS 1070		EN-GJS-700-2, EN-GJS-700-2U	GS700-2	
		0.7080	GGG-80	EN-JS 1080		EN-GJS-800-2		
		5.3400	ADI 800			EN-GJS-800-10		
		0.7090	GGG90	EN-JS1090				
		5.3403	ADI 1000			EN-GJS-1050-6		
		5.3404	ADI 1200			EN-GJS-1200-3		
	5.3405	ADI 1400			EN-GJS-1400-1			
	K3	0.8035	GTW-35, GTW-35-04	EN-GJMW-350-4		GTW-35-04, EN-GJMW-350-4		
		0.8040	GTW-40-05, GTW-40			EN-GJMW-400-5, GTW-40-05		
		0.8045	GTW-45-07, GTW-45			EN-GJMW-450-7		
		0.8135	GTS-35-10, GTS-35			EN-GJMB 350-10		
		0.8145	GTS-45-06, GTS-45			EN-GJMB 450-6, GTS-45-06		
		0.8155	GTS-55-04, GTS-55			EN-GJMB 550-4, GTS-55-04		
		0.8165	GTS 65-02, GTS-65			EN-GJMB 650-2, GTS-65-02		
		0.8170	GTS 70-02, GTS-70			EN-GJMB 700-2, GTS-70-02		
		---	GJV-300	---		---		
		---	GJV-400	---		---		
		---	GJV-500	---		---		

Spanien Spain	Frankreich France	USA U.S.A.	Herstellerbezeichnung Brand Name
UNE	AFNOR	AISI/SAE	AISI / SAE
FG 10	Ft10D, FGL100	ASTM A-48-76	
FG 15	Ft15D, FGL150	NO 20B	
FG 20	Ft20D, FGL200	NO 30B	
FG 25	Ft25D, FGL250	NO 35B	
FG 30	Ft30D, FGL300	NO 40B	
FG 35	Ft35D, FGL350	NO 55B	
	Ft40D, FGL400		
	L-NC 20 2		
	FGS 400-12	60/40/18	
	FGS 500-7	70/50/05	
	FGS 600-3	80/55/06	
	FGS 700-2	"100/70/03 120/90/02"	
	MB 35-7		
	MB 40-10		
	MB 45-7		
	MN 35-10	32510	
	MP 50-5	40010	
	MP 60-3	50005	
		60004	
	MP 70-2	70003	

ISO 513	BZG	Deutschland Germany	Deutschland Germany	Europa Europe	Europa Europe	Italien Italy	
		W.-Nr. Mat.-No.	DIN	W.-Nr. EN Mat.-No. EN	DIN EN	UNI	
N- NE-Metalle / N- non ferrous materials Reinaluminium, Aluminiumknetlegierungen, Aluminiumgusslegierungen, Reinkupfer, Kupferknetlegierungen, Messing, Bronze, Graphit Pure aluminium, aluminium wrought alloys, aluminium cast alloys, pure cooper, cooper wrought alloys, cooper-zinc alloys, cooper alloys, graphite	N1	3.0205	Al99			9001/1	
		3.0255	Al99.5	EN AW-1050A	Al99.5	4507	
		3.0305	Al99.9				
		3.0505	AlMn0.5Mg0.5				
		3.0615	AlMgSiPb				
		3.0915	AlFeSi				8011
		3.1255	AlCuSiMn				9002/3
		3.1325	AlCuMg1				9002/2
		3.1355	AlCuMg2			EN AW-2024	9002/4
		3.1371	G-AlCu4TiMg	EN AC-21000	G-AlCu4TiMg		
		3.1645	AlCuMgPb				9002/8
		3.1655	AlCuBiPb	EN AW-2011	AlCu6BiPb		6362
		3.1734	Y-Legierung			AlCu4Mg1.5Ni2,	3045
		N2	3.2134	G-AlSi5Cu1Mg			
	3.2371		G-AlSi7Mg	EN AC-42100	G-AlSi7Mg,	7257	
	3.2373		G-AlSi9Mg	EN AC-43300	G-AlSi9Mg,	3051	
	3.2381		G-AlSi10Mg	EN AC-43000	G-AlSi10Mg,	3051	
	3.2382		GD-AlSi10Mg	EN AC-43400	AlSi10Mg(Fe)	3051	
	3.2383		G-AlSi10MgCu	EN AC-43200	G-AlSi10MgCu,		
	3.2581		G-AlSi12	EN AC-44200	G-AlSi12,	4514	
	3.2582		GD-AlSi12	EN AC-44300	GD-AlSi12,	4514, G-AlSi13	
	3.2583		G-AlSi12 (Cu)	EN AC-47000	G-AlSi12 (Cu)	3048	
	3.3241		G-AlMg3Si				
	3.3261		G-AlMg5Si				
	3.3315		AlMg1	EN AW-5005A	AlMg1C	5764	
	3.3525		AlMg2Mn0.3				
	3.3527		AlMg2Mn0.8				
	3.3541		G-AlMg3				
	3.3545		AlMg4Mn				9005/4
	3.3555		AlMg5				
	3.3561		G-AlMg5	EN AC-51300	G-AlMg5	3058	
	3.4345	AlZnMgCu0.5	EN AW-7022	AlZnMgCu0.5			
	3.3211						
	3.4335	AlZn4.5Mg1				9007/1	
	3.4365	AlZn5,5MgCu				7075	
	N3	2.0060	E-Cu57				
		2.0065	E-Cu58				5649
		2.0240	CuZn15	CW502L	CuZn15		
		2.0250	CuZn20				
		2.0265	CuZn30	CW505L	CuZn30		
		2.0280	CuZn33				
		2.0321	CuZn37	CW508L	CuZn37		P-CuZn37
		2.0360	CuZn40				
		2.0410	CuZn44Pb2				CuZn43Pb2Al
		2.0550	CuZn40Al2				CuZn37Mn3Al2PbSi

Spanien Spain	Frankreich France	USA U.S.A.	Herstellerbezeichnung Brand Name
UNE	AFNOR	AISI/SAE	AISI / SAE
	1200 (A4)	1200	
L-3051	A5	1050A	
	3105		
	6012		
	8011		
	2014	2014	
	2017 A (AU4G)	2017A	
	2024 (AU4G1)	2024, AA2024	
L-2140	A-U5GT	B26	
	2030 (AU4PB)	2030	
L-3182	A-U5PbBi	2011	
L-2150	A-U4NT		
L-2651	A-S7G0.3	B25	
	A7-S10G	A13560	
L-2560, L-2561	A-S10G	A13600	
L-2560, L-2561	A-S10G	A413.2	
	A-S9GU	A360.2	
L-2520, L-2521	A-S13	A413.2	
L-2520, 21	A-S13, A-S12	A413.0	
L-2530	A-S12U	413.1	
L-3350	A-G0, 6	5005A, 5005	
	5251	5251	
	5049	5049	
	5086 (AG4MC)	5086	
L-3320	A-G6	5056A, 514.1"	
	A-Z5GU0.6		
		6061-T6	
	7020 (AZ5G)	7020	
	7075	7075-T6, AA7075	
		C1100	
	CuA1	C11000	
	CuZn15	C23000	Mittelrotombak,
	CuZn30	C26000	Cartridge Messing,
	CuZn37	C27400	Stimmenmessing,
		C28000	
		C38000	
		C67410	

ISO 513	BZG	Deutschland Germany	Deutschland Germany	Europa Europe	Europa Europe	Italien Italy		
		W.-Nr. Mat.-No.	DIN	W.-Nr. EN Mat.-No. EN	DIN EN	UNI		
N- NE-Metalle / N- non ferrous materials Reinaluminium, Aluminiumknetlegierungen, Aluminiumgusslegierungen, Reinkupfer, Kupferknetlegierungen, Messing, Bronze, Graphit Pure aluminium, aluminium wrought alloys, aluminium cast alloys, pure copper, cooper wrought alloys, cooper-zinc alloys, cooper alloys, graphite	N3	2.0592	GK-CuZn35Al1,	CC765S	CuZn35Mn2Al1Fe1-C			
		2.0596	GK-CuZn34Al2,	CC764S	CuZn34Mn3Al2Fe1-C			
		2.0855	CuNi2Si				CuNi2Si	
		2.0882	CuNi30Mn1Fe					
		2.0940	CuAl10Fe				5274	
		2.0978	CuAl11Ni6Fe6				CuAl11Fe6Ni6	
		2.0966	CuAl10Ni5Fe4	CW307G	CuAl10Ni5Fe4			
		2.0975	G-CuAl11Ni,	CC333G	G-CuAl11Ni		G-CuAl11Fe4Ni4	
		2.1016	CuSn4					
		2.1020	CuSn6				CuSn7	
		2.1030	CuSn8					
		2.1050	G-CuSn10Zn	CC480K	CuSn10-C			
		2.1052	G-CuSn12, GZ-CuSn12, GC-CuSn12	CC483K	CuSn12-C			
		2.1086	G-CuSn10Zn				7013	
		2.1090	G-CuSn7ZnPb, GZ-CuSn7ZnPb, GC-CuSn7ZnPb	CC493K	CuSn7Zn4Pb7-C			
		2.1096	G-CuSn5ZnPb	CC491K	CuSn5Zn5Pb5-C			
		2.1098	G-CuSn2ZnPb	CC490K	CuSn3Zn8Pb5-C			
		2.1176	G-CuPb10Sn, GZ-CuPb10Sn, GC-CuPb10Sn	CC495K	CuSn10Pb10-C			
		2.1182	G-CuPb15Sn, GZ-CuPb15Sn, GC-CuPb15Sn	CC496K	CuSn7Pb15-C			
		2.1188	G-CuPb20Sn	CC497K	CuSn5Pb20-C			
		2.1247	CuBe2				Classe IV	
		2.1285	CuCo2Be				Classe III	
		2.1293	CuCrZr	CW106C	CuCr1Zr		CuCrZr	
		2.1525	CuSi3Mn				CuSi3Mn1	
				CuAl6.5Fe2.5Sn0.25				
				CuAl13Fe4.5				
Graphit	N4							

	Spanien Spain	Frankreich France	USA U.S.A.	Herstellerbezeichnung Brand Name
	UNE	AFNOR	AISI/SAE	AISI / SAE
			C86500	
			C86200	
			C64700	
			C95400	
		CuAl9Ni5Fe3Mn, U-A10N	C63000	
		CuAl11Ni5Fe	B-148-52	
		CuSn6P	C51900	
			C90700	
		"A53-707, CuSn12"	Amcoloy 712, B505	
		U-E12P7U-E8Z2	C90500	
		CuSn7Pb6Zn4	C93200	Rotguss 7
		CuPb5Sn5Zn5	C83600	Rotguss 5 Alloy 5A
		CuPb10Sn10	C93700	
			C93800	
		CuPb20Sn5	C94100	
			C17200	
			C17510	
			C18200	
			C65500	
			AMPCO 8	AMPCO 8
			AMPCO 6	AMPCO 6
			AMPCO 21	AMPCO 21
			AMPCO 26	AMPCO 26

ISO 513	BZG	Deutschland Germany	Deutschland Germany	Europa Europe	Europa Europe	Italien Italy		
		W.-Nr. Mat.-No.	DIN	W.-Nr. EN Mat.-No. EN	DIN EN	UNI		
S - Superlegierungen / S - super alloys Reintitan, Titanlegierungen, Reinnickel, Nickellegierungen Pure titanium, titanium alloys, pure nickel, nickel alloys	S1	3.7024			Ti99.5			
		3.7025	Ti 1		Ti 99.8			
		3.7034			Ti99.7			
	S2	3.7115.1	TiAl 5 Sn 2			TiAl5Sn2.5		
		3.7124	TiCu2			TiCu2		
		3.7164	TiAl 6 V 4			TiAl6V4		
		3.7165	TiAl6V4					
		3.7174	TiAl6V4Sn2					
	S3	1.3912	Ni36			D 1		
		1.3926	RNi12			FeNi48		
	S4	2.4360	NiCu30Fe			NiCu30		
		2.4375	NiCu30Al			NiCu30Al3Ti		
		2.4630	NiCr20Ti					
		2.4632 / 2.4969	NiCr20Co18Ti					
		2.4642	NiCr30Fe					
		2.4654						
		2.4665	NiCr22Fe18Mo					
		2.4668	NiCr19NbMo				NiCr19Fe19Nb5Mo3	
		2.4669	NiCr15Fe7TiAl				NiCr15Fe7Ti2Al	
		2.4698						
		2.4858	NiCr21Mo				NiFe30Cr21Mo3	
		2.4819					NiMo16Cr15W	
		2.4856	NiCr22Mo9Nb				NiCr22Mo9Nb	
	2.4858	NiCr21Mo						
	2.4952 /2.4631	NiCr20TiAl						

ISO 513	BZG	Deutschland Germany	Deutschland Germany	Europa Europe	Europa Europe	Italien Italy	
		W.-Nr. Mat.-No.	DIN	W.-Nr. EN Mat.-No. EN	DIN EN	UNI	
H - gehärtete Werkstoffe, Hartguss H- hardened materials hardened cast iron	H1	1.2343 52HRC	X38CrMoV5-1			X37CrMoV5-1 KU	
		1.2767 54HRC	45NiCrMo16			40NiCrMoV16 KU	
	H2	1.2714 60HRC	56NiCrMoV7			55NiCrMoV7	
		1.2842 58HRC	90MnCrV8				
	H3	1.2080 64HRC	X 210 Cr 12			X210Cr12	X205Cr12KU
		1.2436 63HRC	X 210 CrW 12			X210CrW12-1, X210CrW12	X215CrW121KU
	H4	0.9620 52HRC	G-X260NiCr42		GX260NiCr42		
		0.9650 53HRC	G-X260Cr27		GX260Cr27		

Spanien Spain	Frankreich France	USA U.S.A.	Herstellerbezeichnung Brand Name
UNE	AFNOR	AISI/SAE	AISI / SAE
Ti-PO1	T-35	R2050	Titanium Grade1
		R54620	
Ti-P11	T-U2		
Ti-P63	T-A6V	"4911, 4928, 4935, 4954, 4965, 4967, 6AL4V"	Titanium Grade 5
	T-A6V		
			Invar 36, Alloy 36
			Nilo 48, Alloy 48
	NU30	Monel 400	Monel 400
		AMS 4676, Monel K500	Monel K500
	NC 20 T	Nitronic 75, Nimonic 90/120	Nimonic® 75, Alloy 75
			Nimonic® 90, Alloy 90
		Inconel 690	Inconel 690, Alloy 690
		Waspaloy	
		Alloy X	Hastelloy X
	NC 19 FeNb	Inconel 718	Inconel® 718, Alloy718, Udimet 630
	NC 15 FeTNb	5542G, Inconel X-750	Inconel X-750, Alloy X-750
		Hastelloy C	
	NC 21 FeDU		Incoloy 825
	NC17D	B 574, B 575, B 619, B 622, B 626	Hastelloy® C-276, Alloy C276, Nicrofer 5716 hMoW
	NC 22 FeDNB	Incoloy 825	Inconel® 625, Alloy 625
	NC 21 FeDU	--	Inconel® 825, Alloy 825, Nicrofer® 4221
	NC 20 TA		Alloy 80 A, Nicrofer 7520 Ti

Spanien Spain	Frankreich France	USA U.S.A.	Herstellerbezeichnung Brand Name
UNE	AFNOR	AISI/SAE	AISI / SAE
	Z38CDV5	H11	45 - 54 HRC
	Y35NCD16		
	T61206	L6	54 - 62 HRC
	T31502	O2	
F.5212 X210 Cr12	X200Cr12, Z200C12	D3	62 - 66 HRC
F.5213 X210 CrW12, F.521	X210CrW12-1, Z210CW12-01, Z 210 CW 12	D6	
		Ni-Hard 2	50 - 60 HRC
		A532111A 25% CR	



Vertriebspartner Zerspanung

Distributors cutting tools

Argentinien/Argentina

SIN PAR S.A.
Conesa 10
B1878KSB Quilmes -
Buenos Aires
Tel. +54 11 4257 4396
Fax +54 11 4224 5687
ventas@sinpar.com.ar
www.sinpar.net

Ägypten/Egypt

SOMAN Ltd.
7 Faskia St.
11451 Garden City,
Cairo Egypt
Tel + 20 2 27956075
Fax + 20 2 27943216
sales@soman-eg.com

Bulgarien/Bulgaria

Saint George Group LTD
Kuklensko shose 17i str
Plovdiv 4003
Tel. + 359 32 67 81 40
Tel. + 359 32 68 02 40
stgeorge.office@gmail.com

China/China

Golden Carbide (Shanghai) Co., Ltd
Room 2101-2102, Gateway
International Plaza Building A,
No.325, Tian Yao Qiao Road,
Shanghai China Zip:200030
Tel. +86-21-33632088
Fax +86-21-33633303
info@goldencarbide.com
www.goldencarbide.com

HORN (Shanghai) Trading Co. Ltd.
Room 905, No 518 Anyuan Road
Putuo District
Shanghai 20060
Tel. +86 21 528 33 505, 528 33 205
Fax +86 21 528 32 562
info@phorn.cn
www.phorn.cn

Dänemark/Danmark

JR TOOL ApS
Porschevej 1
7100 Vejle
Telefon + 45 7582 9066
info@jr-tool.dk
www.jr-tool.dk

Deutschland/Germany

Paul Horn GmbH
Horn-Straße 1,
72072 Tübingen
Deutschland/Germany
Tel. +49 7071-7004-0
Fax +49 7071-72893
info@phorn.de
www.phorn.de

Finnland/Finland

KESTTOOLS OY
Paljekujia 4
42700 KEURUU
Tel. +358 40 5145152
peter.jaatinen@kestools.fi
www.kestools.fi

Frankreich/France

Horn SAS
665 Av Blaise Pascal
77127 Lieusaint
Tel. +33 164 88 59 58
Fax +33 164 88 60 49
infos@horn.fr
www.horn.fr

Horn SAS

564 rue Claude Ballaloud
ZAE Bord d'Arve
74950 Scionzier
Tel. +33 4050 183148
Fax +33 4050 182171
contact@horn.fr
www.horn.fr

Griechenland/Greece

G. Economou & Co. O.E.
Representations
13, Gr. Lambraki Str.
GR-14561 KIFISIA (BY ATHENS)
Tel. +30-210-8014808
Fax +30-210-8014808
g-econ@otenet.gr

Großbritannien/ United Kingdom

HORN CUTTING TOOLS Ltd.
32 New Street, Ringwood,
Hampshire BH24 3AD
Tel. +44 1425 481 800
Fax +44 1425 481 888
info@phorn.co.uk
www.phorn.co.uk

LMT UK LTD

The Old School Room
204 Main Road
Meriden
CV7 7NG
Tel. +44 121 717 5830
lmt.uk@lmt-tools.com
www.lmt-uk.co.uk

Indonesien/Indonesia

MITRA TOOLSINDO MANDIRI, CV
Heavenland Park K-3 Sidoarjo
East Java Indonesia 61271
Tel. +62 318 068 084/85
Fax +62 318 067 889
samuel@mitratoolsindo.co.id

Kroatien/Bosnien & Herzegowina

Croatia/Bosnia & Herzegovina
Montenegro/Montenegro
HORN Magyarország Kft.
Gesztenyefa u. 4
9027 Győr
Tel. +36 96 55 05 31
Fax +36 96 55 05 32
technik@phorn.hu
www.horn.hu

Estland, Lettland, Litauen/ Estonia, Latvia, Lithuania

SIA "INSTRO", Lacplesa 87d,
Riga, LV 1011, Lettland
Tel. +371-67288546
Fax +371-67287787
elina@instro.lv
www.instro.lv

Malaysia/Malaysia

Bohlasia Steels Sdn Bhd
No. 18 Jalan Utarid U5/15,
Seksyen U5
40150 Shah Alam
Tel. +60 3 7842 1448
Fax +60 3 7842 1454
sales@bohler-bohlasia.com.my
www.bohler-bohlasia.com.my

Niederlande/Netherlands

Hagro Precisie b.v.
Industriepark 18
5374 CM Schaijk
Tel. +31 486 462 424
Fax +31 486 461 650
hagro@hagro.nl
www.hagro.nl

Rumänien/Romania

Profil Construct Expert SRL
Street Beothy Odon, no. 9A
410604, Oradea, Bihor
Tel. +40 359 176 400
Tel. +40 745 411 695
office@pcetools.ro
www.pcetools.ro

Russland/Russia

HORN RUS LLC
5 Bryanskaya street
121059, Moscow
Tel. +7 495 968 21 68
Fax +7 495 960 21 68
www.hornrus.com

Schweden/Sweden

HORN Sverige & Danmark
Powered by JR TOOL ApS
HORN Sverige
Noravägen 1
691 53 Karlskoga
Tel. + 46 19 / 277 76 06
info@phorn.se
www.phorn.se

Schweiz/Switzerland

Vargus (Schweiz) AG
Knonauerstraße 56
6330 Cham 1
Tel. +41 41 784 21 21
Fax +41 41 784 21 39
info@vargus.ch
www.vargus.ch

Serbien/Serbia

Hahn+Kolb
Pančevački put 36v
11210 Beograd
Tel. +381 11 20 78 256
Fax +381 11 20 78 225
office@hahn-kolb.rs
www.hahn-kolb.rs

Singapur/Singapore

Leitz Tooling Asia Pte Ltd.
1 Clementi Loop #04-01
Singapore 129 808
Tel. +65 64 62 53 68
Fax +65 64 62 40 02
leitz@leitz.org
www.leitztools.com

Slowenien/Slovenia

KAČ trade d.o.o.
Ložnica pri Žalcu 46
3310 Zalec
Tel. +386 3 710 40 80
Fax +386 3 710 40 81
info@kactrade.si
www.kactrade.com

Südkorea/South Korea

NEO-TECH CO.,LTD.
70-12, Hyoseong-ro,
Nam-gu, Pohang-si,
Gyeongsangbuk-do,
South Korea
Telefon +82 54 282 7077
Telefax +82 54 282 2009
yic7077@naver.com
NEOTECH (neotech09.kr)

Taiwan/Taiwan

Golden Carbide Inc.
5F., No. 300, Sec. 4, Zhongxiao E.
Rd., Taipei,
Taiwan ZIP: 106
Tel: 886-2-77555038
Fax: 886-2-27717557
info@goldencarbide.com
www.goldencarbide.com

Thailand/Thailand

Horn Thailand
700/712 Moo
1 Tambol Panthong Amphur Panthong
20160 Chonburi
Tel. +66 033135060
sales@th.horn-group.com

Solution Service & Supply Co., Ltd.

No.5 Soi Suan-Siam 6 Yak 2,
Suan-Siam Road,
Kannayao, Kannayao, Bangkok 10230
Thailand
Tel. +66 2919 7176
Fax +66 2518-1196
surapong@solutionss.co.th

USA

Kanada/Canada
HORN USA, Inc.
1870 General George Patton
Dr Franklin, TN37067
Tel. +1 888 818-4676
Fax +1 615 771-4101
sales@hornusa.com
www.hornusa.com

Vietnam/Vietnam

NhatHa Engineering Co., ltd
PLot 321 Ngo Quyen Str,
Quang Trung Ward,
Ha Dong District, Hanoi City,
Vietnam
Telefon +84 97 545 88 77
nhatha@nhatha.com.vn
nhatha.com.vn/a

Boehlerit GmbH & Co. KG
Werk VI-Straße 100
8605 Kapfenberg
Österreich/Austria
Telefon +43 3862 300 - 0
Telefax +43 3862 300 - 793
sales-at@boehlerit.com
www.boehlerit.com

boehlerit

Vertriebstöchter und Repräsentanten *Subsidiaries and representatives*

Brasilien/Brazil

Boehlerit Brasil Ferramentas Ltda.
Rua Capricórnio 72
Alpha Conde Comercial I
06473-005 - Barueri -
São Paulo
Tel. +55 11 554 60 755
Fax +55 11 554 60 476
info@boehlerit.com.br
www.boehlerit.com.br

Deutschland/Germany

(Verschleiß/Wear parts)
Boehlerit GmbH & Co. KG
Heidenheimer Straße 108
D-73447 Oberkochen
Telefon +49 7364 950-700
Telefax +49 7364 950-720
bid@boehlerit.de
www.boehlerit.de

Indien/India

Boehlerit India
Otto Bilz Private Limited
No.5A-5B/6A,
KIADB Industrial Area
Doddaballapur-561 203
Bangalore District, Karnataka
Tel. +91-080-22638700
Fax +91-080-22638702
Venkat@bilztool.com
www.boehlerit.com

Italien/Italy

Boehlerit Italy S.r.l.
Via Papa Giovanni XXIII, Nr. 45
20053 Rodano (MI)
Tel. +39 02 269 49 71
Fax +39 02 218 72 456
info@boehlerit.it
www.boehlerit.it

Mexiko/Mexico

Boehlerit S.A. de C.V.
Av. Acueducto No. 15
Parque Industrial Bernardo Quintana
El Marqués, Querétaro
México. C.P. 76246
Tel. +52 442 296 6804
info@boehlerit.com.mx
www.boehlerit.com.mx

Österreich/Austria

Boehlerit GmbH & Co. KG
Werk VI-Straße 100
8605 Kapfenberg
Österreich/Austria
Telefon +43 3862 300 - 0
Telefax +43 3862 300 - 793
sales-at@boehlerit.com
www.boehlerit.com

Polen/Poland

Boehlerit Polska sp.z.o.o.
Zlotniki, ul. Kobaltowa 6
62-002 Suchy Las
Tel. +48 61 659 38 00
Fax +48 61 623 20 14
info@boehlerit.pl
www.boehlerit.pl

Slowakei/Slovakia

Kancelár Boehlerit
Santraziny 753
760 01 Zlín
Tel. +420 577 214 989
Fax +420 577 219 061
boehlerit@boehlerit.com
www.boehlerit.com

Spanien/Spain

Boehlerit Spain S.L.
**C/ Tecnología, 82 Pasaje C
Nave 22
08450 Llinars del Valles
Barcelona**
Tel. +34 93 750 7907
info@boehlerit.es
www.boehlerit.es

Tschechien/Czech Republic

Kancelár Boehlerit
Santraziny 753
760 01 Zlín
Tel. +420 577 214 989
Fax +420 577 219 061
info.cz@boehlerit.com
www.boehlerit.com

Türkei/Turkey

Boehlerit
Sert Metal ve Takım San. ve Tic. A.Ş.
Gosb 1600. Sok.No: 1602
41480 Gebze - Kocaeli
Tel. +90 262 677 1737
Fax +90 262 677 1746
info@boehlerit.com.tr
www.boehlerit.com.tr

Ungarn/Hungary

Boehlerit Hungária Kft.
2036 Érdliget Pf. 32
2030-Érd, Kis-Duna u.6.
Tel. +36 23 521 910
Fax +36 23 521 919
info@boehlerit.hu
www.boehlerit.hu

USA

Kanada/Canada

Boehlerit USA
Bilz USA
1140 No.Main St.
Lombard IL 60148
Tel. +1 847 734 9390
Fax 1 847 734 9391
www.boehlerit.com